































ASL Bible Dictionary

Spoken Word	SignWriting
-dan	
.	
1	
1 Samuel 30:6	
1/10	
1/2	
1/3	
1/4	
10	









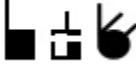

ASL Bible Dictionary

Spoken Word	SignWriting
10	
100	
101	
102	
103	
104	
105	
106	
107	
108	
109	









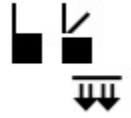

ASL Bible Dictionary

Spoken Word	SignWriting
11	
110	
110	
111	
111	
112	
112	
113	
113	
114	
114	
115	













ASL Bible Dictionary

Spoken Word	SignWriting
115	
116	
116	
117	
117	
118	
118	
119	
119	
12	
120	
120	





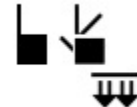







ASL Bible Dictionary

Spoken Word	SignWriting
121	
121	
122	
122	
123	
123	
124	
124	
125	
126	
126	











ASL Bible Dictionary

Spoken Word	SignWriting
127	
127	
128	
128	
129	
129	
13	
130	
131	
132	
133	
133	
134	









ASL Bible Dictionary

Spoken Word	SignWriting
135	
136	
137	
138	
139	
14	
140	
141	
142	
143	
144	
144	
145	







ASL Bible Dictionary

Spoken Word	SignWriting
146	
147	
148	
149	
15	
150	
151	
152	
153	
153	











ASL Bible Dictionary

Spoken Word	SignWriting
154	
155	
155	
156	
157	
158	
159	
16	
160	









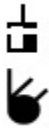

ASL Bible Dictionary

Spoken Word	SignWriting
161	
162	
1620	
1621	
1623	
163	
1630	









ASL Bible Dictionary

Spoken Word	SignWriting
1631	
164	
165	
166	
166	
167	
167	
168	
168	
1682	







ASL Bible Dictionary

Spoken Word	SignWriting
169	
169	
17	
170	
171	
172	
173	
1732	
174	
175	







ASL Bible Dictionary

Spoken Word	SignWriting
176	
176	
1761	
177	
177	
1775	
1776	
178	







ASL Bible Dictionary

Spoken Word	SignWriting
178	
1780	
1785	
1787	
1788	
1789	







ASL Bible Dictionary

Spoken Word	SignWriting
179	
179	
1790	
1791	
1797	
1798	
1799	





ASL Bible Dictionary

Spoken Word	SignWriting
18	
180	
1800	
1803	
1805	
1808	
1809	





ASL Bible Dictionary

Spoken Word	SignWriting
181	
1812	
1814	
1817	
182	
1821	
1822	





ASL Bible Dictionary

Spoken Word	SignWriting
1824	
1827	
1829	
183	
1830	



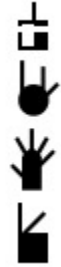

ASL Bible Dictionary

Spoken Word	SignWriting
1830s	 <p>The SignWriting for '1830s' consists of a vertical sequence of five symbols: a square with a horizontal line above it, a circle with a horizontal line above it, a square with a diagonal line from top-left to bottom-right, a solid black circle, and a hand with fingers spread.</p>
1831	 <p>The SignWriting for '1831' consists of a vertical sequence of four symbols: a square with a horizontal line above it, a circle with a horizontal line above it, a square with a diagonal line from top-left to bottom-right, and a solid black square.</p>
1833	 <p>The SignWriting for '1833' consists of a vertical sequence of five symbols: a square with a horizontal line above it, a circle with a horizontal line above it, a square with a diagonal line from top-left to bottom-right, a hand with fingers spread, and a hand with the index finger pointing to the right.</p>
1837	 <p>The SignWriting for '1837' consists of a vertical sequence of five symbols: a square with a horizontal line above it, a circle with a horizontal line above it, a square with a diagonal line from top-left to bottom-right, a hand with fingers spread, and a solid black circle.</p>
184	 <p>The SignWriting for '184' consists of a vertical sequence of three symbols: a solid black square, a hand with fingers spread, and a hand with fingers spread.</p>



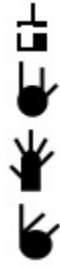

ASL Bible Dictionary

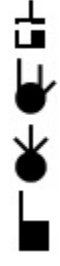
Spoken Word	SignWriting
1840s	 <p>A vertical sequence of five SignWriting symbols: a square with a cross, a hand with fingers spread, a hand with fingers spread, a solid circle, and a hand with fingers spread.</p>
1846	 <p>A vertical sequence of four SignWriting symbols: a square with a cross, a hand with fingers spread, a hand with fingers spread, and a solid circle.</p>
185	 <p>Three SignWriting symbols arranged horizontally: a square with a cross, a hand with fingers spread, and a hand with fingers spread.</p>
1852	 <p>A vertical sequence of four SignWriting symbols: a square with a cross, a hand with fingers spread, a hand with fingers spread, and a square.</p>
1853	 <p>A vertical sequence of four SignWriting symbols: a square with a cross, a hand with fingers spread, a hand with fingers spread, and a square.</p>



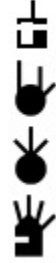
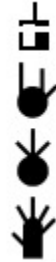
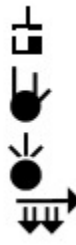



ASL Bible Dictionary

Spoken Word	SignWriting
1854	
1855	
1857	
186	
186	
1861	





ASL Bible Dictionary

Spoken Word	SignWriting
1864	
1865	
1866	
1867	
1869	
187	







ASL Bible Dictionary

Spoken Word	SignWriting
187	
1873	
1877	
188	
188	
1887	
1889	





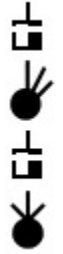

ASL Bible Dictionary

Spoken Word	SignWriting
189	
189	
1891	
1896	



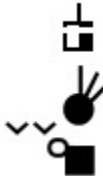



ASL Bible Dictionary

Spoken Word	SignWriting
18th	
19	
190	
1902	
1903	
191	
1912	
1916	

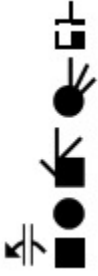
ASL Bible Dictionary

Spoken Word	SignWriting
1917	
1919	
192	
1920	
1924	
193	
1930	







ASL Bible Dictionary

Spoken Word	SignWriting
1930s	
1931	
1932	
1933	
1939	
194	





ASL Bible Dictionary

Spoken Word	SignWriting
1940's	<p>The SignWriting for '1940's' consists of a vertical sequence of five symbols: a square with a horizontal line above it, a hand with fingers spread, a solid black circle, another hand with fingers spread, and a square with a horizontal line above it.</p>
1943	<p>The SignWriting for '1943' consists of a vertical sequence of four symbols: a square with a horizontal line above it, a hand with fingers spread, another hand with fingers spread, and a square with a horizontal line above it.</p>
1945	<p>The SignWriting for '1945' consists of a vertical sequence of four symbols: a square with a horizontal line above it, a hand with fingers spread, another hand with fingers spread, and a hand with fingers spread.</p>
1947	<p>The SignWriting for '1947' consists of a vertical sequence of four symbols: a square with a horizontal line above it, a hand with fingers spread, another hand with fingers spread, and a solid black circle.</p>
1949	<p>The SignWriting for '1949' consists of a vertical sequence of five symbols: a square with a horizontal line above it, a hand with fingers spread, a solid black circle, another hand with fingers spread, and a hand with fingers spread.</p>



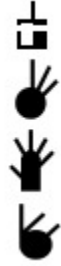
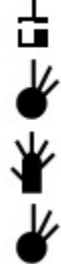

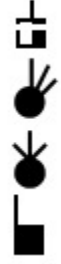

ASL Bible Dictionary

Spoken Word	SignWriting
195	
1951	
1952	
1953	
1954	
1955	

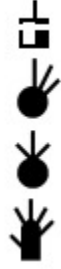



ASL Bible Dictionary

Spoken Word	SignWriting
1957	
1959	
196	
196	
1960	
1961	







ASL Bible Dictionary

Spoken Word	SignWriting
1965	
1966	
1967	
1968	
197	
197	





ASL Bible Dictionary

Spoken Word	SignWriting
1970	
1971	
1972	
1973	
1974	



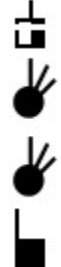
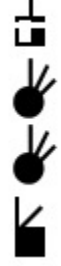

ASL Bible Dictionary

Spoken Word	SignWriting
1975	
198	
198	
1980	
1981	
1982	







ASL Bible Dictionary

Spoken Word	SignWriting
1983	
1988	
199	
199	
1991	
1992	

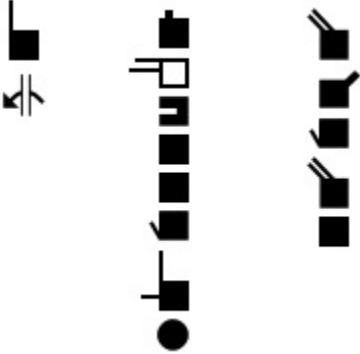

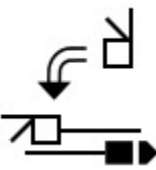

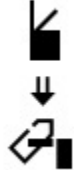

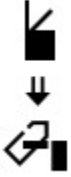
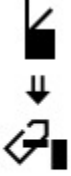

ASL Bible Dictionary

Spoken Word	SignWriting
1993	
1994	
1998	
1999	
1st	

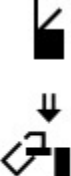

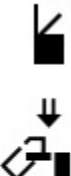

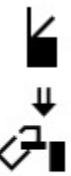
ASL Bible Dictionary

Spoken Word	SignWriting
1Thessalonians	
2	
2 more	
2-days	
2-of-them	
2-thousand	
20	
200	









ASL Bible Dictionary

Spoken Word	SignWriting
2000	
2001	 
2002	 
2003	 
2004	 









ASL Bible Dictionary

Spoken Word	SignWriting
2005	
2006	
2007	
2008	
2009	













ASL Bible Dictionary

Spoken Word	SignWriting
201	
2010	
2011	
2012	
202	
203	
204	
205	











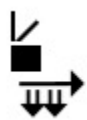

ASL Bible Dictionary

Spoken Word	SignWriting
206	
207	
208	
209	
21	
210	
211	
211	



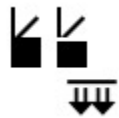









ASL Bible Dictionary

Spoken Word	SignWriting
212	
212	
213	
213	
214	
214	
215	
215	
216	
216	
217	
217	
218	











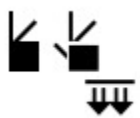

ASL Bible Dictionary

Spoken Word	SignWriting
218	
219	
219	
22	
220	
220	
221	
221	
222	
222	
223	
223	
224	











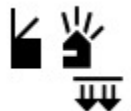

ASL Bible Dictionary

Spoken Word	SignWriting
224	
225	
225	
226	
226	
227	
227	
228	
228	
229	
229	
23	
230	













ASL Bible Dictionary

Spoken Word	SignWriting
231	
232	
233	
233	
234	
235	
236	
237	
238	
239	
24	
240	
241	













ASL Bible Dictionary

Spoken Word	SignWriting
242	
243	
244	
244	
245	
246	
247	
248	
249	
25	
250	
251	
252	









ASL Bible Dictionary

Spoken Word	SignWriting
253	
254	
255	
255	
256	
257	
258	
259	
26	
260	
261	
262	
263	













ASL Bible Dictionary

Spoken Word	SignWriting
264	
265	
266	
266	
267	
267	
268	
268	
269	
269	
27	
270	
271	













ASL Bible Dictionary

Spoken Word	SignWriting
272	
273	
274	
275	
276	
276	
277	
277	
278	











ASL Bible Dictionary

Spoken Word	SignWriting
278	
279	
279	
28	
280	
281	
282	
283	
284	
285	
286	
286	
287	





ASL Bible Dictionary

Spoken Word	SignWriting
287	
288	
288	
289	
289	
29	
290	
291	
292	
293	
294	
295	
296	



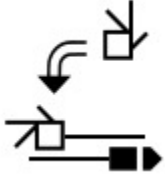
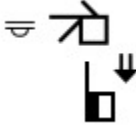
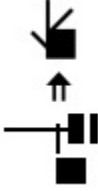

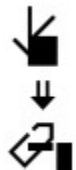
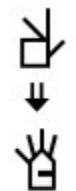



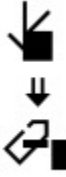

ASL Bible Dictionary

Spoken Word	SignWriting
296	
297	
297	
298	
298	
299	
299	
2Thessalonians	
3	
3	













ASL Bible Dictionary

Spoken Word	SignWriting
3-days	
3-months	
3-oclock	
3-of-them	
3-of-us	
3-thousand	
3/4	
30	













ASL Bible Dictionary

Spoken Word	SignWriting
300	
3000	
301	
302	
303	
304	
305	
306	
307	
308	
309	
31	







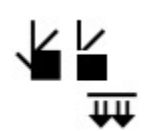

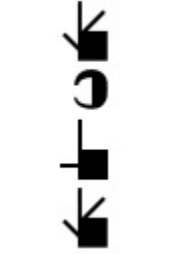

ASL Bible Dictionary

Spoken Word	SignWriting
310	
311	
311	
312	
312	
313	
313	
314	
314	
315	
315	
316	
316	

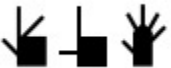



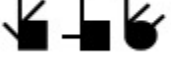

ASL Bible Dictionary

Spoken Word	SignWriting
317	
317	
318	
318	
319	
319	
32	
320	
320	
321	
321	
322	
322	



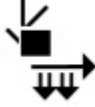









ASL Bible Dictionary

Spoken Word	SignWriting
323	
323	
324	
324	
325	
325	
326	
326	
327	
327	
328	
328	













ASL Bible Dictionary

Spoken Word	SignWriting
329	
329	
33	
330	
331	
332	













ASL Bible Dictionary

Spoken Word	SignWriting
333	
333	
334	
335	
336	
337	
338	
339	
34	
340	
341	
342	
343	











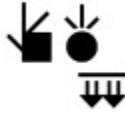

ASL Bible Dictionary

Spoken Word	SignWriting
344	
344	
345	
346	
347	
348	
349	
35	
350	
351	
352	
353	
354	













ASL Bible Dictionary

Spoken Word	SignWriting
355	
355	
356	
357	
358	
359	
36	
360	
361	
362	
363	
364	
365	











ASL Bible Dictionary

Spoken Word	SignWriting
366	
366	
367	
367	
368	
368	
369	
369	
37	
370	
371	
372	
373	





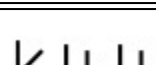
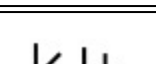







ASL Bible Dictionary

Spoken Word	SignWriting
374	
375	
376	
376	
377	
377	
378	
378	
379	
379	
38	
380	







ASL Bible Dictionary

Spoken Word	SignWriting
381	
382	
383	
384	
385	
386	
386	
387	
387	
388	
388	
389	
389	

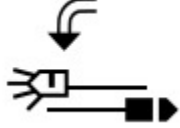
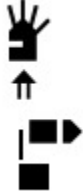

ASL Bible Dictionary

Spoken Word	SignWriting
39	
390	
391	
392	
393	
394	
395	
396	
396	
397	
397	
398	

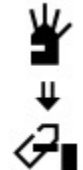









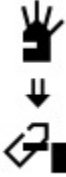

ASL Bible Dictionary

Spoken Word	SignWriting
398	
399	
399	
4	
4-13	
4-days	
4-oclock	
4-of-them	
4-thousand	













ASL Bible Dictionary

Spoken Word	SignWriting
40	
400	





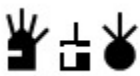





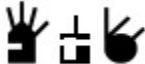

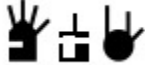
ASL Bible Dictionary

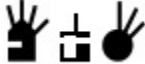
Spoken Word	SignWriting
4000	
401	
402	
403	
404	
405	
406	
407	
408	
409	
41	
410	





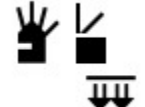





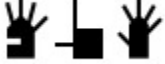

ASL Bible Dictionary

Spoken Word	SignWriting
411	
411	
412	
412	
413	
413	
414	
414	
415	
415	
416	
416	
417	













ASL Bible Dictionary

Spoken Word	SignWriting
417	
418	
418	
419	
419	
42	
420	
420	
421	
421	
422	
422	
423	













ASL Bible Dictionary

Spoken Word	SignWriting
423	
424	
424	
425	
425	
426	
426	
427	
427	
428	
428	
429	
429	













ASL Bible Dictionary

Spoken Word	SignWriting
43	
430	
431	
432	
433	
433	
434	
435	
436	
437	
438	
439	











ASL Bible Dictionary

Spoken Word	SignWriting
44	
440	
441	
442	
443	
444	
444	
445	
446	
447	
448	
449	





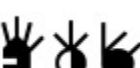

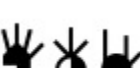





ASL Bible Dictionary

Spoken Word	SignWriting
45	
450	
451	
452	
453	
454	
455	
455	
456	
457	
458	
459	
46	











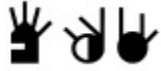

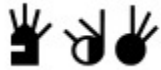
ASL Bible Dictionary

Spoken Word	SignWriting
460	
461	
462	
463	
464	
465	
466	
466	
467	
467	
468	
468	













ASL Bible Dictionary

Spoken Word	SignWriting
469	
469	
47	
470	
471	
472	
473	
474	
475	
476	
476	
477	
477	











ASL Bible Dictionary

Spoken Word	SignWriting
478	
478	
479	
479	
48	
480	
481	
482	
483	
484	
485	
486	
486	







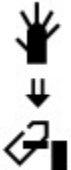



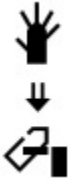

ASL Bible Dictionary

Spoken Word	SignWriting
487	
487	
488	
488	
489	
489	
49	
490	
491	
492	
493	
494	
495	













ASL Bible Dictionary

Spoken Word	SignWriting
496	
496	
497	
497	
498	
498	
499	
4th	
5	
5	
5-thousand	













ASL Bible Dictionary

Spoken Word	SignWriting
50	
500	
5000	
501	
502	
503	
504	
505	
506	
507	
508	
509	











ASL Bible Dictionary

Spoken Word	SignWriting
51	
510	
510	
511	
512	
513	
514	
515	
516	
517	
518	
519	
52	



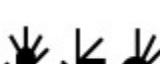









ASL Bible Dictionary

Spoken Word	SignWriting
520	
521	
522	
523	
524	
525	
526	
527	
528	
529	
53	
530	
531	











ASL Bible Dictionary

Spoken Word	SignWriting
532	
533	
534	
535	
536	
537	
538	
539	
54	
540	
541	
542	





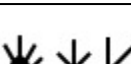
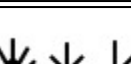
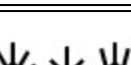

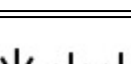





ASL Bible Dictionary

Spoken Word	SignWriting
543	
544	
545	
546	
547	
548	
549	
55	
550	
551	
552	
553	
554	













ASL Bible Dictionary

Spoken Word	SignWriting
555	
556	
557	
558	
559	
56	
560	
561	
562	
563	
564	
565	
566	













ASL Bible Dictionary

Spoken Word	SignWriting
567	
568	
569	
57	
570	
571	
572	
573	
574	
575	
576	
577	
578	











ASL Bible Dictionary

Spoken Word	SignWriting
579	
58	
580	
581	
582	
583	
584	
585	
586	
587	
588	
589	
59	









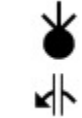

ASL Bible Dictionary

Spoken Word	SignWriting
590	
591	
592	
593	
594	
595	
596	
597	
598	
599	
5th	
6	

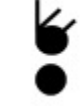



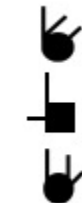







ASL Bible Dictionary

Spoken Word	SignWriting
60	
600	
61	
62	
63	
632	
64	
65	
66	
67	
68	

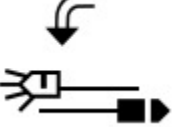

ASL Bible Dictionary

Spoken Word	SignWriting
684	
69	
69	
6th	
7	
70	
700	
71	
72	
728	
73	













ASL Bible Dictionary

Spoken Word	SignWriting
74	
75	
76	
77	
78	
78	
79	
79	
7th	
8	
8 days	
80	





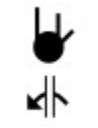





ASL Bible Dictionary

Spoken Word	SignWriting
800	 The signwriting for the number 800 consists of two parts: a hand sign for the digit 8 (with the thumb pointing down and the index and middle fingers extended) followed by a hand sign for the digit 0 (with the hand held flat, palm facing forward).
81	 The signwriting for the number 81 consists of two parts: a hand sign for the digit 8 (with the thumb pointing down and the index and middle fingers extended) followed by a hand sign for the digit 1 (with the index finger extended).











ASL Bible Dictionary

Spoken Word	SignWriting
82	
83	
84	
85	
86	
86	
87	
88	
89	
89	
8th	
9	





ASL Bible Dictionary

Spoken Word	SignWriting
90	
900	
91	
92	
93	
94	
95	
96	
97	
98	
989	





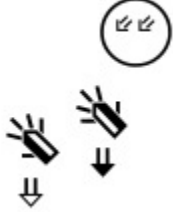

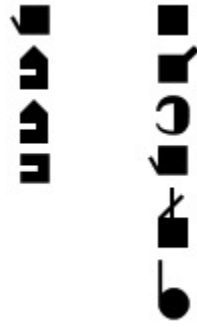
ASL Bible Dictionary

Spoken Word	SignWriting
99	
9th	
;	
;	
;	
;	
;	
A	
A1	
aa	
Aaron	

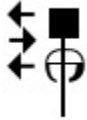

ASL Bible Dictionary

Spoken Word	SignWriting
Abaddon	
Abagtha	
abandon	
Abba	
Abbe Sicard	

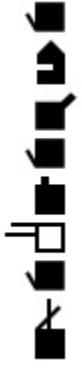
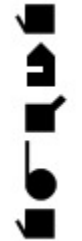

ASL Bible Dictionary

Spoken Word	SignWriting
Abbe Sicard	
abc	
Abda	
Abednego	
Abednego	
Abel	

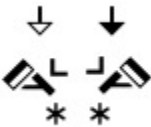

ASL Bible Dictionary

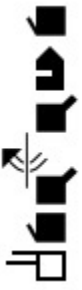
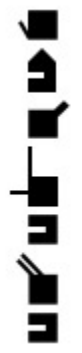
Spoken Word	SignWriting
Abelmizraim	 <p>A vertical sequence of 14 handshapes representing the sign for Abelmizraim. From top to bottom: a hand with fingers spread, a hand with index and middle fingers extended, a hand with index and middle fingers extended, a hand with index and middle fingers extended, a hand with index and middle fingers extended, a hand with index and middle fingers extended, a hand with index and middle fingers extended, a hand with index and middle fingers extended, a hand with index and middle fingers extended, a hand with index and middle fingers extended, a hand with index and middle fingers extended, a hand with index and middle fingers extended, a hand with index and middle fingers extended, and a hand with index and middle fingers extended.</p>
Abiathar	 <p>A vertical sequence of 10 handshapes representing the sign for Abiathar. From top to bottom: a hand with fingers spread, a hand with index and middle fingers extended, a hand with index and middle fingers extended, a hand with index and middle fingers extended, a hand with index and middle fingers extended, a hand with index and middle fingers extended, a hand with index and middle fingers extended, a hand with index and middle fingers extended, a hand with index and middle fingers extended, and a hand with index and middle fingers extended.</p>
Abida	 <p>A vertical sequence of 5 handshapes representing the sign for Abida. From top to bottom: a hand with fingers spread, a hand with index and middle fingers extended, a hand with index and middle fingers extended, a hand with index and middle fingers extended, and a hand with index and middle fingers extended.</p>
abide	 <p>A vertical sequence of 2 handshapes representing the sign for abide. From top to bottom: a hand with index and middle fingers extended, and a hand with index and middle fingers extended.</p>
abide	 <p>A vertical sequence of 4 handshapes representing the sign for abide. From top to bottom: a hand with index and middle fingers extended, a hand with index and middle fingers extended, a hand with index and middle fingers extended, and a hand with index and middle fingers extended.</p>





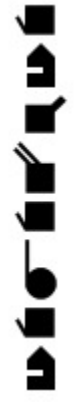
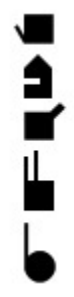

ASL Bible Dictionary

Spoken Word	SignWriting
Abihail	
Abijah	
Abilene	
Abimael	

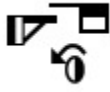
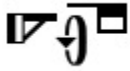
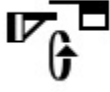





ASL Bible Dictionary

Spoken Word	SignWriting
Abimelech	
Abinadab	
Abiud	
able	
Abner	





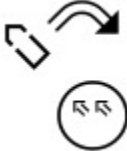



ASL Bible Dictionary

Spoken Word	SignWriting
about	
about	
about	
about	
about	
about	
about	
about	
above	
above	

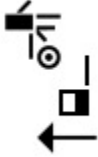
ASL Bible Dictionary

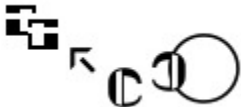
Spoken Word	SignWriting
above	
above	
above	
above	
above	
Abraham	
Abraham	





ASL Bible Dictionary

Spoken Word	SignWriting
Abraham	
Abram	
absent	
absolute	
absorb	
abundance	
abundant	
Acacia	

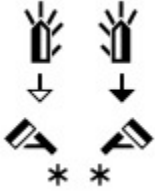
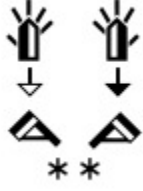
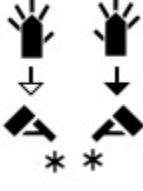

ASL Bible Dictionary

Spoken Word	SignWriting
acacias	
academics	
academy	
Accad	
accent	





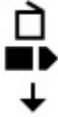

ASL Bible Dictionary

Spoken Word	SignWriting
accept	
accept	
accept	
accept	
accept	
access	
accomplish	
according	





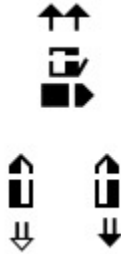
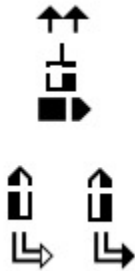

ASL Bible Dictionary

Spoken Word	SignWriting
according to	
accounts	
accuse	

ASL Bible Dictionary

Spoken Word	SignWriting
accuse	
accuse	
accuse	
accuse	
accuser	
accusers	
accusing	







ASL Bible Dictionary

Spoken Word	SignWriting
Achaia	
Achaicus	
Achbor	
achieve	
acquainted	
acre	

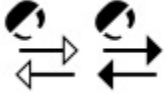

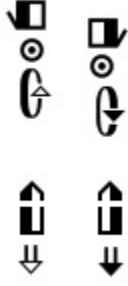



ASL Bible Dictionary

Spoken Word	SignWriting
acres	<p>The sign for 'acres' is written vertically. It starts with a hand sign for 'A' (open palm, fingers together, thumb up), followed by a hand sign for 'C' (open palm, fingers together, thumb up, with a small circle above the palm), then a hand sign for 'R' (open palm, fingers together, thumb up, with a small circle above the palm), and finally a hand sign for 'S' (open palm, fingers together, thumb up, with a small circle above the palm).</p>
acronym	<p>The sign for 'acronym' is written vertically. It starts with a hand sign for 'A' (open palm, fingers together, thumb up), followed by a hand sign for 'C' (open palm, fingers together, thumb up, with a small circle above the palm), then a hand sign for 'R' (open palm, fingers together, thumb up, with a small circle above the palm), then a hand sign for 'O' (open palm, fingers together, thumb up, with a small circle above the palm), then a hand sign for 'N' (open palm, fingers together, thumb up, with a small circle above the palm), and finally a hand sign for 'Y' (open palm, fingers together, thumb up, with a small circle above the palm).</p>
across	<p>The sign for 'across' is written vertically. It starts with a hand sign for 'A' (open palm, fingers together, thumb up), followed by a hand sign for 'C' (open palm, fingers together, thumb up, with a small circle above the palm), and finally a hand sign for 'S' (open palm, fingers together, thumb up, with a small circle above the palm).</p>
across	<p>The sign for 'across' is written vertically. It starts with a hand sign for 'A' (open palm, fingers together, thumb up), followed by a hand sign for 'C' (open palm, fingers together, thumb up, with a small circle above the palm), and finally a hand sign for 'S' (open palm, fingers together, thumb up, with a small circle above the palm).</p>
Act	<p>The sign for 'Act' is written vertically. It starts with a hand sign for 'A' (open palm, fingers together, thumb up), followed by a hand sign for 'C' (open palm, fingers together, thumb up, with a small circle above the palm), and finally a hand sign for 'T' (open palm, fingers together, thumb up, with a small circle above the palm).</p>
act	<p>The sign for 'act' is written vertically. It starts with a hand sign for 'A' (open palm, fingers together, thumb up), followed by a hand sign for 'C' (open palm, fingers together, thumb up, with a small circle above the palm), and finally a hand sign for 'T' (open palm, fingers together, thumb up, with a small circle above the palm).</p>
action	<p>The sign for 'action' is written vertically. It starts with a hand sign for 'A' (open palm, fingers together, thumb up), followed by a hand sign for 'C' (open palm, fingers together, thumb up, with a small circle above the palm), and finally a hand sign for 'N' (open palm, fingers together, thumb up, with a small circle above the palm).</p>
action	<p>The sign for 'action' is written vertically. It starts with a hand sign for 'A' (open palm, fingers together, thumb up), followed by a hand sign for 'C' (open palm, fingers together, thumb up, with a small circle above the palm), and finally a hand sign for 'N' (open palm, fingers together, thumb up, with a small circle above the palm).</p>

ASL Bible Dictionary

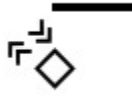
Spoken Word	SignWriting
actions	
active	
actor	
Acts	
Adah	
Adaiah	





ASL Bible Dictionary

Spoken Word	SignWriting
Adalia	
Adam	
Adam	
Adam	
Adam	
Adams	
Adbeel	



ASL Bible Dictionary

Spoken Word	SignWriting
add	<p>The sign for 'add' is composed of four distinct handshapes arranged vertically. From top to bottom: a hand with fingers spread and thumb up; a hand with index and middle fingers extended and thumb down; a hand with index and middle fingers extended and thumb up; and a hand with index and middle fingers extended and thumb up.</p>
Addi	<p>The sign for 'Addi' consists of four handshapes in a vertical sequence: a square handshape, a hand with index and middle fingers extended and thumb up, a hand with index and middle fingers extended and thumb up, and a square handshape.</p>
addiction	<p>The sign for 'addiction' features a hand with index and middle fingers extended and thumb up, followed by a square handshape, and then a circular handshape.</p>
addition	<p>The sign for 'addition' is formed by a square handshape, a hand with index and middle fingers extended and thumb up, and a hand with index and middle fingers extended and thumb up.</p>
address	<p>The sign for 'address' is composed of two identical vertical sequences of handshapes. Each sequence starts with a hand with index and middle fingers extended and thumb up, followed by a square handshape.</p>
Adin	<p>The sign for 'Adin' consists of four handshapes in a vertical sequence: a square handshape, a hand with index and middle fingers extended and thumb up, a hand with index and middle fingers extended and thumb up, and a square handshape.</p>
Admah	<p>The sign for 'Admah' is composed of four handshapes in a vertical sequence: a square handshape, a hand with index and middle fingers extended and thumb up, a hand with index and middle fingers extended and thumb up, and a square handshape.</p>

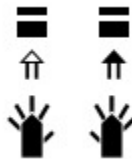

ASL Bible Dictionary

Spoken Word	SignWriting
Admatha	
Admin	
admit	
Adna	
Adonijah	

ASL Bible Dictionary

Spoken Word	SignWriting
Adonikam	
adopt	
adore	
Adramyttium	

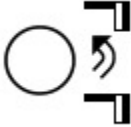

ASL Bible Dictionary

Spoken Word	SignWriting
Adria	
Adullam	
Adullamite	
adult	

ASL Bible Dictionary

Spoken Word	SignWriting
adulterer	<p>The signwriting for 'adulterer' consists of three main components: a handshape starting with the index finger pointing right and moving down, followed by a handshape starting with the index finger pointing up and moving down, and finally a handshape starting with the index finger pointing up and moving down.</p>
adulterers	<p>The signwriting for 'adulterers' consists of three main components: a handshape starting with the index finger pointing right and moving down, followed by a handshape starting with the index finger pointing up and moving down, and finally a handshape starting with the index finger pointing up and moving down.</p>
adultery	<p>The signwriting for 'adultery' is a complex sequence of handshapes: a handshape starting with the index finger pointing down and moving right, followed by a handshape starting with the index finger pointing up and moving right, then a handshape starting with the index finger pointing up and moving right, and finally a handshape starting with the index finger pointing up and moving right.</p>
adultery	<p>The signwriting for 'adultery' consists of two main components: a handshape starting with the index finger pointing right and moving down, followed by a handshape starting with the index finger pointing up and moving down.</p>
adults	<p>The signwriting for 'adults' consists of three main components: a handshape starting with the index finger pointing up and moving right, followed by a handshape starting with the index finger pointing up and moving right, and finally a handshape starting with the index finger pointing up and moving right.</p>
advance	<p>The signwriting for 'advance' consists of two main components: a handshape starting with the index finger pointing up and moving right, followed by a handshape starting with the index finger pointing up and moving right.</p>

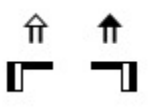

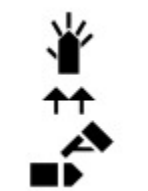
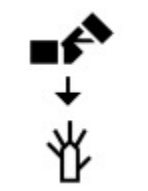
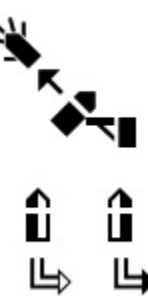





ASL Bible Dictionary

Spoken Word	SignWriting
advance	
advanced	
advice	
advice	
advise	
advise	
advisers	

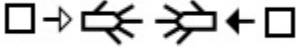
ASL Bible Dictionary

Spoken Word	SignWriting
advisers	<p>The SignWriting for 'advisers' consists of two parts. The top part shows a hand with fingers spread, moving down and then right, followed by a hand with fingers spread, moving up and then right. The bottom part shows two hands, each with fingers spread, moving up and then right.</p>
advisers	<p>The SignWriting for 'advisers' consists of two parts. The top part shows a hand with fingers spread, moving up and then right, followed by a hand with fingers spread, moving up and then right. The bottom part shows two hands, each with fingers spread, moving up and then right.</p>
Aeneas	<p>The SignWriting for 'Aeneas' is a vertical sequence of seven hand movements: a hand with fingers spread moving down, a hand with fingers spread moving down, a hand with fingers spread moving down, a hand with fingers spread moving down, a hand with fingers spread moving down, a hand with fingers spread moving down, and a hand with fingers spread moving down.</p>
Aenon	<p>The SignWriting for 'Aenon' is a vertical sequence of seven hand movements: a hand with fingers spread moving down, a hand with fingers spread moving down, a hand with fingers spread moving down, a hand with fingers spread moving down, a hand with fingers spread moving down, a hand with fingers spread moving down, and a hand with fingers spread moving down.</p>
AFC	<p>The SignWriting for 'AFC' is a vertical sequence of three hand movements: a hand with fingers spread moving down, a hand with fingers spread moving down, and a hand with fingers spread moving down.</p>





ASL Bible Dictionary

Spoken Word	SignWriting
affair	
AFL	
afraid	
Africa	
after	
after	
after	
after-all	

ASL Bible Dictionary

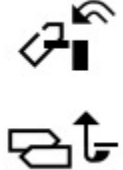
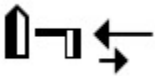
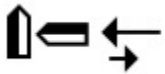
Spoken Word	SignWriting
afternoon	
afterward	
Agabus	
Agag	
Agagite	
again	
again	
again	

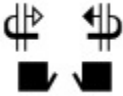
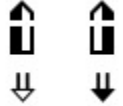
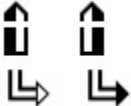

ASL Bible Dictionary

Spoken Word	SignWriting
again	
again born	
against	
against	
against	
agate	
agency	
agent	
agents	
aggressive	

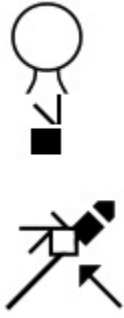
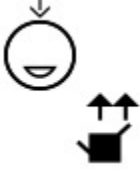

ASL Bible Dictionary

Spoken Word	SignWriting
aggressive	<p>The SignWriting for 'aggressive' consists of two rows of symbols. The first row has two identical symbols, each consisting of an upward-pointing arrow above a square. The second row has three symbols: a hand with fingers spread, a square with a downward-pointing arrow, and another square with a downward-pointing arrow.</p>
agree	<p>The SignWriting for 'agree' consists of two rows of symbols. The first row has a circle and a hand with the index finger pointing. The second row has two parallel vertical lines above two solid black squares.</p>



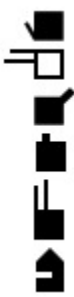

ASL Bible Dictionary

Spoken Word	SignWriting
Agrippa	 <p>The signwriting for 'Agrippa' consists of a vertical sequence of seven symbols: a square with a horizontal line above it, a square with a horizontal line above it, a square with a horizontal line above it, a diamond with a horizontal line above it, a diamond with a horizontal line above it, a diamond with a horizontal line above it, and a square with a horizontal line above it.</p>
aground	 <p>The signwriting for 'aground' consists of two parts. The first part is a circle with a horizontal line below it, followed by a square with a horizontal line above it. The second part is a square with a horizontal line above it, followed by a square with a horizontal line above it, and a square with a horizontal line above it.</p>
ah	 <p>The signwriting for 'ah' consists of a circle with a horizontal line below it, followed by a square with a horizontal line above it, and a square with a horizontal line above it.</p>
Ahasuerus	 <p>The signwriting for 'Ahasuerus' consists of a vertical sequence of ten symbols: a square with a horizontal line above it, a square with a horizontal line above it, a square with a horizontal line above it, a square with a horizontal line above it, a square with a horizontal line above it, a square with a horizontal line above it, a square with a horizontal line above it, a square with a horizontal line above it, a square with a horizontal line above it, and a square with a horizontal line above it.</p>
Ahaz	 <p>The signwriting for 'Ahaz' consists of a vertical sequence of four symbols: a square with a horizontal line above it, a square with a horizontal line above it, a square with a horizontal line above it, and a square with a horizontal line above it.</p>



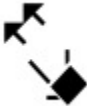

ASL Bible Dictionary

Spoken Word	SignWriting
Ahiah	
Ahitub	
Aholibamah	
Ahuzzath	

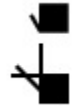
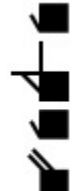

ASL Bible Dictionary

Spoken Word	SignWriting
Ahzai	
aid	
aides	
Aija	
airhead	
airplane	









ASL Bible Dictionary

Spoken Word	SignWriting
Ajah	
Ajah	
AK	
Akan	
Akeldama	
Akim	





ASL Bible Dictionary

Spoken Word	SignWriting
Akkub	
Al-Sayyid	
alabaster	
Alabemos al Senor 1	
Alabemos al Senor 2	
Alabemos al Senor 3	



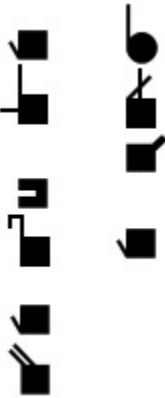

ASL Bible Dictionary

Spoken Word	SignWriting
Alan	
alarm	
Alaska	
Alaska	
Alaska	
alcohol	
alcohol	
alcohol	



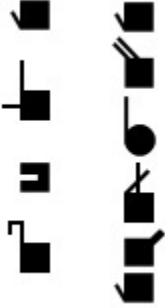

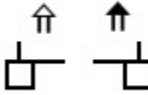



ASL Bible Dictionary

Spoken Word	SignWriting
alert	
alert	
Aleut	
Alexander	
Alexandria	



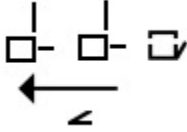



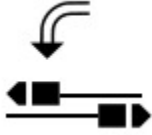

ASL Bible Dictionary

Spoken Word	SignWriting
Alexandria	 <p>The SignWriting for 'Alexandria' consists of two vertical columns of symbols. The left column contains five symbols: a square with a vertical line on the right, a square with a vertical line on the left, a square with a vertical line on the right, a square with a vertical line on the left, and a square with a vertical line on the right. The right column contains six symbols: a square with a vertical line on the right, a square with a vertical line on the left, a square with a vertical line on the right, a square with a vertical line on the left, a square with a vertical line on the right, and a square with a vertical line on the left.</p>
Alexandria	 <p>The SignWriting for 'Alexandria' is a single vertical column of seven symbols: a square with a vertical line on the right, a square with a vertical line on the left, a square with a vertical line on the right, a square with a vertical line on the left, a square with a vertical line on the right, a square with a vertical line on the left, and a square with a vertical line on the right.</p>
Alice	 <p>The SignWriting for 'Alice' is a single vertical column of five symbols: a square with a vertical line on the right, a square with a vertical line on the left, a square with a vertical line on the right, a square with a vertical line on the left, and a square with a vertical line on the right.</p>
alive	 <p>The SignWriting for 'alive' consists of two vertical columns of two symbols each. The left column contains a square with a vertical line on the right and a square with a vertical line on the left. The right column contains a square with a vertical line on the right and a square with a vertical line on the left.</p>
all	 <p>The SignWriting for 'all' consists of four symbols arranged in a diamond shape. Each symbol is a square with a vertical line on the right. Arrows indicate the direction of movement between the symbols: from the top to the right, from the right to the bottom, from the bottom to the left, and from the left to the top.</p>

ASL Bible Dictionary

Spoken Word	SignWriting
all	
all	
all	
all	
all	
all	
all	
all	
all 3	



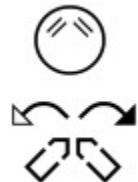



ASL Bible Dictionary

Spoken Word	SignWriting
all day	
all gone	
all night	
all over	
all over	
all right	
all you	
all you	
all you	

ASL Bible Dictionary

Spoken Word	SignWriting
allow	<p>The sign for 'allow' is written in two columns. The left column consists of a downward arrow with a hook on the left side, positioned above a vertical rectangle with a small upward arrow on its top edge. The right column consists of a downward arrow with a hook on the right side, positioned above a vertical rectangle with a small upward arrow on its top edge.</p>
allyn	<p>The sign for 'allyn' is a vertical sequence of five handshapes: a square, a square with a horizontal line extending to the right, a square with a horizontal line extending to the left, a square with a diagonal line from the top-left to the bottom-right, and a square with a diagonal line from the top-right to the bottom-left.</p>
Almighty	<p>The sign for 'Almighty' is written in two columns. The top row shows a hand with fingers spread on the left and a hand with fingers spread on the right. The bottom row shows a square with an upward arrow on its top edge on the left, and a square with an upward arrow on its top edge on the right.</p>
Almodad	<p>The sign for 'Almodad' is a vertical sequence of seven handshapes: a square, a square with a horizontal line extending to the right, a hand with fingers spread, a square, a circle, a square with a horizontal line extending to the right, a square with a horizontal line extending to the left, and a circle.</p>
almonds	<p>The sign for 'almonds' is a vertical sequence of seven handshapes: a square, a square with a horizontal line extending to the right, a hand with fingers spread, a square, a circle, a square with a diagonal line from the top-left to the bottom-right, and a circle.</p>







ASL Bible Dictionary

Spoken Word	SignWriting
almost	
almost	
almost	
aloes	
alone	
Alpha	
alphabet	

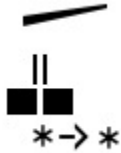

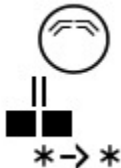
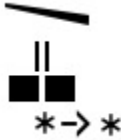

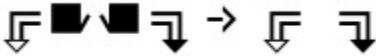

ASL Bible Dictionary

Spoken Word	SignWriting
alphabet	<p>The SignWriting for 'alphabet' consists of a vertical sequence of 11 signs. From top to bottom: a hand with fingers spread pointing up; a hand with index finger pointing up; a hand with index finger pointing up and thumb pointing left; a hand with index finger pointing up and thumb pointing right; a hand with index finger pointing up and thumb pointing left; a hand with index finger pointing up and thumb pointing right; a hand with index finger pointing up and thumb pointing left; a hand with index finger pointing up and thumb pointing right; a hand with index finger pointing up and thumb pointing left; a hand with index finger pointing up and thumb pointing right; and a hand with index finger pointing up and thumb pointing left.</p>
Alphaeus	<p>The SignWriting for 'Alphaeus' consists of a vertical sequence of 11 signs. From top to bottom: a hand with index finger pointing up; a hand with index finger pointing up and thumb pointing left; a hand with index finger pointing up and thumb pointing right; a hand with index finger pointing up and thumb pointing left; a hand with index finger pointing up and thumb pointing right; a hand with index finger pointing up and thumb pointing left; a hand with index finger pointing up and thumb pointing right; a hand with index finger pointing up and thumb pointing left; a hand with index finger pointing up and thumb pointing right; a hand with index finger pointing up and thumb pointing left; and a hand with index finger pointing up and thumb pointing right.</p>
already	<p>The SignWriting for 'already' consists of two pairs of signs. The first pair shows a hand with index finger pointing up and thumb pointing left, followed by a hand with index finger pointing up and thumb pointing right. The second pair shows a hand with index finger pointing up and thumb pointing left, followed by a hand with index finger pointing up and thumb pointing right.</p>
already	<p>The SignWriting for 'already' consists of two pairs of signs. The first pair shows a hand with index finger pointing up and thumb pointing left, followed by a hand with index finger pointing up and thumb pointing right. The second pair shows a hand with index finger pointing up and thumb pointing left, followed by a hand with index finger pointing up and thumb pointing right.</p>
also	<p>The SignWriting for 'also' consists of a circle with two horizontal lines inside, positioned above two parallel horizontal lines. Below these lines is a hand with index finger pointing up and thumb pointing right, followed by a hand with index finger pointing up and thumb pointing left.</p>
also	<p>The SignWriting for 'also' consists of two parallel horizontal lines, positioned above two parallel horizontal lines. Below these lines is a hand with index finger pointing up and thumb pointing right, followed by a hand with index finger pointing up and thumb pointing left.</p>

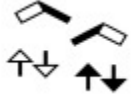
ASL Bible Dictionary

Spoken Word	SignWriting
also	
also	
also	
also	
also	
altar	
altars	
although	





ASL Bible Dictionary

Spoken Word	SignWriting
although	
Alva	
Alvah	
Alvan	
Alvin	
always	







ASL Bible Dictionary

Spoken Word	SignWriting
always	<p>The sign is composed of a circle on the left and a square on the right. The square has a vertical line extending downwards from its top edge. Below the square is a hand icon with the index finger pointing down and slightly to the right.</p>
always	<p>The sign consists of a horizontal line on the left. To its right is a vertical line with an upward-pointing arrow above it. Below these lines is a hand icon with the index finger pointing up.</p>
always	<p>The sign consists of a square on the left with a vertical line extending downwards from its top edge. Below the square is a hand icon with the index finger pointing down and slightly to the right.</p>
always	<p>The sign is composed of a circle on the left with a downward arrow above it and an upward arrow below it. To the right of the circle is a square with a vertical line extending downwards from its top edge. Below the square is a hand icon with the index finger pointing down and slightly to the right.</p>
Alyeska	<p>The sign is a vertical sequence of seven hand icons. From top to bottom: 1. Hand with index finger pointing up. 2. Hand with index finger pointing right. 3. Hand with index finger pointing down. 4. Hand with index finger pointing left. 5. Hand with index finger pointing up. 6. Hand with index finger pointing right. 7. Hand with index finger pointing down.</p>
AM	<p>The sign consists of a hand icon with the index finger pointing up, followed by a hand icon with the index finger pointing right.</p>
am	<p>The sign consists of a hand icon with the index finger pointing up, followed by a hand icon with the index finger pointing right.</p>



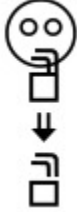

ASL Bible Dictionary

Spoken Word	SignWriting
Amalek	
Amalekites	
Amariah	
Amashsai	

ASL Bible Dictionary

Spoken Word	SignWriting
amazed	
amazed	
amazed	
amazed	
amazed	
amazed	
amazed	



ASL Bible Dictionary

Spoken Word	SignWriting
Amaziah	
ambassadors	
ambulance	
ambush	
amen	



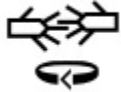
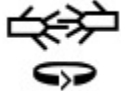
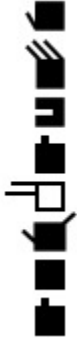

ASL Bible Dictionary

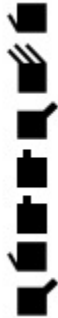
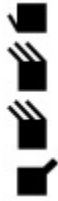
Spoken Word	SignWriting
amen	
amend	
amend	
America	
America	
America	
american	





ASL Bible Dictionary

Spoken Word	SignWriting
American	
American	
amethyst	
amita	
Amittai	
ammi	



ASL Bible Dictionary

Spoken Word	SignWriting
Amminadab	
Ammon	
Ammonites	
Amok	





ASL Bible Dictionary

Spoken Word	SignWriting
Amon	
among	
Amorites	
Amorites	
Amos	

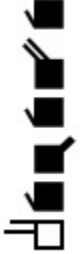
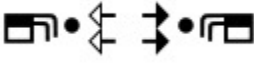

ASL Bible Dictionary

Spoken Word	SignWriting
Amhipolis	 A vertical sequence of 11 sign-writing symbols for the word 'Amhipolis'. From top to bottom: a square with a diagonal line from top-left to bottom-right; a square with a diagonal line from top-right to bottom-left; a square with a vertical line and a horizontal line extending to the right; a square with a vertical line and a horizontal line extending to the right; a square with a vertical line and a horizontal line extending to the right; a square with a vertical line and a horizontal line extending to the right; a square with a vertical line and a horizontal line extending to the right; a square with a vertical line and a horizontal line extending to the right; a square with a vertical line and a horizontal line extending to the right; a square with a vertical line and a horizontal line extending to the right; a square with a vertical line and a horizontal line extending to the right.
Ampliatus	 A vertical sequence of 11 sign-writing symbols for the word 'Ampliatus'. From top to bottom: a square with a diagonal line from top-left to bottom-right; a square with a diagonal line from top-right to bottom-left; a square with a vertical line and a horizontal line extending to the right; a square with a vertical line and a horizontal line extending to the right; a square with a vertical line and a horizontal line extending to the right; a square with a vertical line and a horizontal line extending to the right; a square with a vertical line and a horizontal line extending to the right; a square with a vertical line and a horizontal line extending to the right; a square with a vertical line and a horizontal line extending to the right; a square with a vertical line and a horizontal line extending to the right; a square with a vertical line and a horizontal line extending to the right.
Amraphel	 A vertical sequence of 11 sign-writing symbols for the word 'Amraphel'. From top to bottom: a square with a diagonal line from top-left to bottom-right; a square with a diagonal line from top-right to bottom-left; a square with a vertical line and a horizontal line extending to the right; a square with a vertical line and a horizontal line extending to the right; a square with a vertical line and a horizontal line extending to the right; a square with a vertical line and a horizontal line extending to the right; a square with a vertical line and a horizontal line extending to the right; a square with a vertical line and a horizontal line extending to the right; a square with a vertical line and a horizontal line extending to the right; a square with a vertical line and a horizontal line extending to the right; a square with a vertical line and a horizontal line extending to the right.

ASL Bible Dictionary

Spoken Word	SignWriting
Amzi	
Anah	
Anaheim	
Anaiah	
analyze	
Anamim	

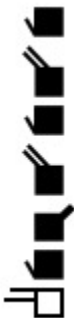

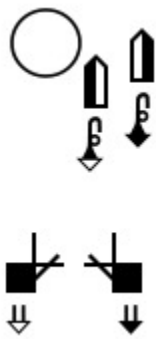



ASL Bible Dictionary

Spoken Word	SignWriting
Ananiah	
Ananias	
Anathoth	
ancestor	

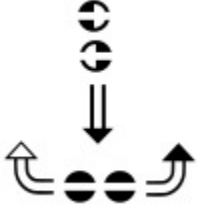

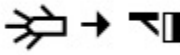

ASL Bible Dictionary

Spoken Word	SignWriting
ancestor	<p>The signwriting for 'ancestor' consists of a circle on the left, followed by two vertical bars with downward-pointing arrows, and two curved arrows pointing downwards from the bars.</p>
ancestor	<p>The signwriting for 'ancestor' consists of a circle on the left, followed by two vertical bars with downward-pointing arrows, and two curved arrows pointing downwards from the bars. Below this are two vertical bars with upward-pointing arrows.</p>
ancestors	<p>The signwriting for 'ancestors' consists of two vertical bars with downward-pointing arrows, two curved arrows pointing downwards from the bars, a circle on the left, and two vertical bars with downward-pointing arrows.</p>
ancestry	<p>The signwriting for 'ancestry' consists of a circle on the left, followed by two vertical bars with downward-pointing arrows, and two curved arrows pointing downwards from the bars.</p>
anchor	<p>The signwriting for 'anchor' consists of a vertical bar with a downward-pointing arrow, a square, a vertical bar with a downward-pointing arrow, a circle, a square, a vertical bar with a downward-pointing arrow, a circle, and a vertical bar with a downward-pointing arrow.</p>









ASL Bible Dictionary

Spoken Word	SignWriting
anchor	
Anchorage	
and	
and	
and	
and	
and	







ASL Bible Dictionary

Spoken Word	SignWriting
Andover	
Andrew	
Andronicus	
Aner	



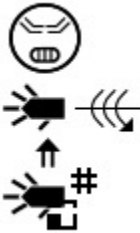

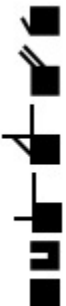

ASL Bible Dictionary

Spoken Word	SignWriting
angel	
angels	
angels	
anger	
anger	
anger-simmer	
angle	
angry	

ASL Bible Dictionary

Spoken Word	SignWriting
angry	
angry	
angry	
angry	
animal	
animals	
animals	
ankles	



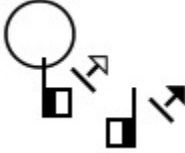
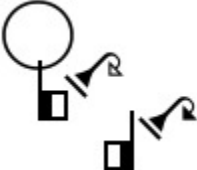

ASL Bible Dictionary

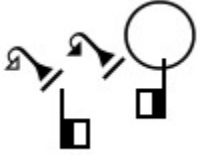
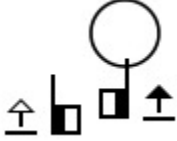
Spoken Word	SignWriting
Anna	
Annas	
announce	
announcing	
anointed	
another	
answer	
answer	

ASL Bible Dictionary

Spoken Word	SignWriting
answer	 The SignWriting for 'answer' consists of three main components: a hand sign with the index finger pointing up and the thumb pointing left, a hand sign with the index finger pointing up and the thumb pointing right, and a hand sign with the index finger pointing up and the thumb pointing right, with a circle above it.
answer	 The SignWriting for 'answer' consists of four main components: a hand sign with the index finger pointing up and the thumb pointing left, a hand sign with the index finger pointing up and the thumb pointing right, a hand sign with the index finger pointing up and the thumb pointing right with a circle above it, and a hand sign with the index finger pointing up and the thumb pointing right.





ASL Bible Dictionary

Spoken Word	SignWriting
antichrist	 <p>The SignWriting for 'antichrist' consists of two parts. The first part is a vertical rectangle with a horizontal line extending to the right from its top edge, and a horizontal line extending to the left from its bottom edge. The second part is a circle with a vertical line through its center, a small asterisk to its left, and a downward-pointing arrow with an asterisk to its right.</p>
antichrist	 <p>The SignWriting for 'antichrist' consists of two parts. The first part is a vertical rectangle with a horizontal line extending to the right from its top edge, and a horizontal line extending to the left from its bottom edge. The second part is a circle with a vertical line through its center, a small asterisk to its left, and a downward-pointing arrow with an asterisk to its right.</p>
Antioch	 <p>The SignWriting for 'Antioch' is a vertical sequence of seven symbols: a square with a diagonal line from top-left to bottom-right, a square with a diagonal line from top-right to bottom-left, a square with a horizontal line through its center, a square with a vertical line through its center, a circle with a vertical line through its center, a circle with a horizontal line through its center, and a square with a horizontal line extending to the right from its top edge.</p>
Antipas	 <p>The SignWriting for 'Antipas' is a vertical sequence of seven symbols: a square with a diagonal line from top-left to bottom-right, a square with a diagonal line from top-right to bottom-left, a square with a horizontal line through its center, a square with a vertical line through its center, a square with a horizontal line extending to the right from its top edge, a diamond with a diagonal line from top-left to bottom-right, and a square with a horizontal line extending to the right from its top edge.</p>

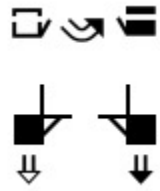
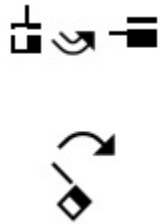
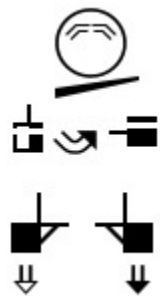

ASL Bible Dictionary

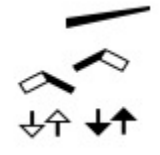
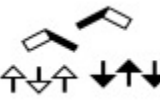
Spoken Word	SignWriting
Antipatris	
anxious	
anxious	
any	
any	
any more	

ASL Bible Dictionary

Spoken Word	SignWriting
anyone	
anyone	
anyone	
anything	
anyway	
anyway	
apart	

ASL Bible Dictionary

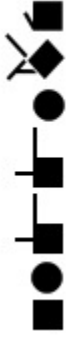
Spoken Word	SignWriting
<p>Apelles</p>	
<p>Apollonia</p>	
<p>Apollos</p>	



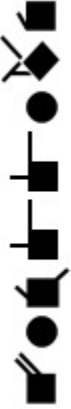
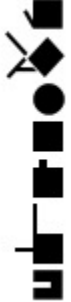
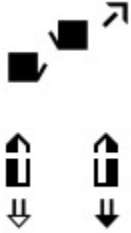
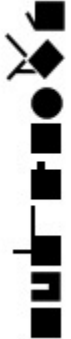



ASL Bible Dictionary

Spoken Word	SignWriting
<p>Apollyon</p>	
<p>Apostle</p>	
<p>apostle</p>	
<p>Apostles</p>	

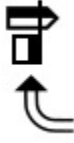







ASL Bible Dictionary

Spoken Word	SignWriting
apostles	<p>The signwriting for 'apostles' consists of two main parts. The upper part shows three squares arranged in a diagonal line from bottom-left to top-right, with arrows indicating the movement from one square to the next. The lower part shows two vertical rectangles, each with a small square at its base and an arrow pointing downwards from that square.</p>
appeal	<p>The signwriting for 'appeal' is a vertical sequence of symbols. From top to bottom: a circle with a smiling face and an upward-pointing arrow; a square with an upward-pointing arrow; a square with a downward-pointing arrow; a square with a horizontal line extending to the left; a square with a vertical line extending upwards; a square with a vertical line extending downwards; a square with a curved arrow pointing to the right; and finally, two vertical rectangles.</p>
appeal	<p>The signwriting for 'appeal' is a vertical sequence of symbols. From top to bottom: a square with a diagonal line from top-left to bottom-right; a square with a diagonal line from top-right to bottom-left; a square with a horizontal line extending to the left; a square with a vertical line extending upwards; a square with a vertical line extending downwards; and a square with a horizontal line extending to the left.</p>
appeal	<p>The signwriting for 'appeal' features a central circle. To its left is a square with a vertical line extending upwards from its top edge. To its right is a square with a vertical line extending upwards from its top edge, and above that is another square with a vertical line extending upwards from its top edge. Below the central circle are two squares, each with a vertical line extending upwards from its top edge.</p>
appear	<p>The signwriting for 'appear' shows two vertical rectangles. The one on the right has a double-lined arrow pointing downwards and to the left towards its top-right corner.</p>



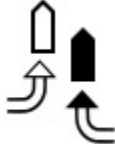

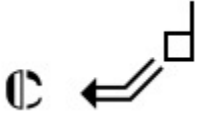
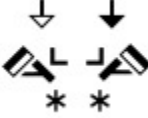
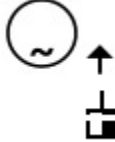
ASL Bible Dictionary

Spoken Word	SignWriting
appear	
Apphia	
Appian	
applause	
apple	
apple	
appoint	



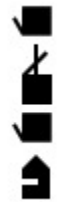

ASL Bible Dictionary

Spoken Word	SignWriting
appoint	
appointment	
approach	
approach	
approach	
approach	
approach group	
approve	
approve	
approximate	



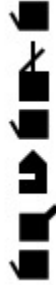



ASL Bible Dictionary

Spoken Word	SignWriting
April	
apron	
aprons	
Aquila	
Arab	



ASL Bible Dictionary

Spoken Word	SignWriting
Arabia	
Arabs	
Arah	
Aram	
Aramaic	

ASL Bible Dictionary

Spoken Word	SignWriting
Arameans	
Aran	
Ararat	
Arbah	
Arbah	
arc	



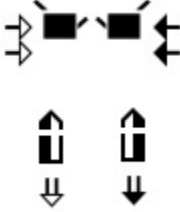
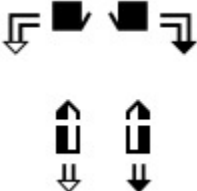





ASL Bible Dictionary

Spoken Word	SignWriting
Archelaus	 <p>The SignWriting for 'Archelaus' consists of a vertical sequence of symbols: a square with a diagonal line from top-left to bottom-right, a square with a diagonal line from top-right to bottom-left, a circle, a square with a horizontal line above it, a square with a horizontal line below it, a square with a horizontal line above it, a square with a horizontal line below it, a square with a horizontal line above it, and a square with a horizontal line below it.</p>
Archippus	 <p>The SignWriting for 'Archippus' consists of a vertical sequence of symbols: a square with a diagonal line from top-left to bottom-right, a square with a diagonal line from top-right to bottom-left, a circle, a square with a horizontal line above it, a square with a horizontal line below it, a diamond with a diagonal line from top-left to bottom-right, a diamond with a diagonal line from top-right to bottom-left, a square with a horizontal line above it, and a square with a horizontal line below it.</p>
architect	 <p>The SignWriting for 'architect' consists of two rows of symbols. The top row has two squares with diagonal lines from top-left to bottom-right, each with a small arrow pointing to the right. The bottom row has two squares with horizontal lines, each with a small arrow pointing up and a small arrow pointing down.</p>
architect	 <p>The SignWriting for 'architect' consists of two rows of symbols. The top row has two squares with diagonal lines from top-left to bottom-right, each with a small arrow pointing to the right. The bottom row has two squares with horizontal lines, each with a small arrow pointing up and a small arrow pointing down.</p>





ASL Bible Dictionary

Spoken Word	SignWriting
architects	<p>The SignWriting for 'architects' consists of a sequence of signs: a square with a diagonal line, a square with a diagonal line, a circle, a square with a horizontal line, a square with a diagonal line, a square with a diagonal line, a circle, a square with a diagonal line, a square with a diagonal line, and a square with a diagonal line.</p>
architecture	<p>The SignWriting for 'architecture' consists of a sequence of signs: a square with a diagonal line, a square with a diagonal line, a circle, a square with a horizontal line, a square with a diagonal line, a square with a diagonal line, a circle, a square with a diagonal line, a square with a diagonal line, a square with a diagonal line, and a square with a diagonal line.</p>
archive	<p>The SignWriting for 'archive' consists of a sequence of signs: a square with a diagonal line, a square with a diagonal line, a circle, a square with a horizontal line, a square with a diagonal line, a square with a diagonal line, and a square with a diagonal line.</p>



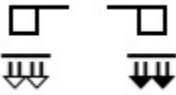
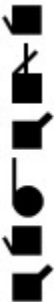

ASL Bible Dictionary

Spoken Word	SignWriting
Arctic	
Ard	
ardent	
are	
area	
area	
area	
area	



ASL Bible Dictionary

Spoken Word	SignWriting
area	
area	
areas	
Arelī	
Aretas	
argues	
Aridai	



ASL Bible Dictionary

Spoken Word	SignWriting
Aridatha	
Arimathea	
Arioch	
Arioch	

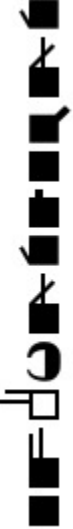

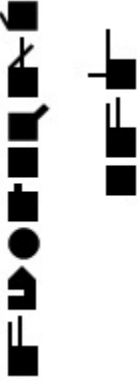

ASL Bible Dictionary

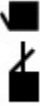
Spoken Word	SignWriting
Arisai	
arise	
arise	
Aristarchus	



ASL Bible Dictionary

Spoken Word	SignWriting
Aristobulus	 <p>The SignWriting for 'Aristobulus' consists of two vertical columns of signs. The left column contains 11 signs: a square with a horizontal line, a square with a vertical line, a square with a diagonal line, a square with a horizontal line, a square with a vertical line, a square with a diagonal line, a square with a horizontal line, a square with a vertical line, a square with a diagonal line, a square with a horizontal line, and a square with a vertical line. The right column contains 4 signs: a square with a horizontal line, a square with a vertical line, a square with a diagonal line, and a square with a horizontal line.</p>
Ark	 <p>The SignWriting for 'Ark' consists of two vertical columns of signs. The left column contains 2 signs: a square with a horizontal line and a square with a vertical line. The right column contains 2 signs: a square with a horizontal line and a square with a vertical line.</p>
Arkansas	 <p>The SignWriting for 'Arkansas' consists of two vertical columns of signs. The left column contains 2 signs: a square with a horizontal line and a square with a vertical line. The right column contains 2 signs: a square with a horizontal line and a square with a vertical line.</p>

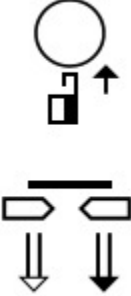

ASL Bible Dictionary

Spoken Word	SignWriting
Arkansas	 <p>A vertical sequence of eight sign-writing symbols for the word 'Arkansas'. From top to bottom: a square with a diagonal line from top-left to bottom-right; a square with a diagonal line from top-right to bottom-left; a square with a horizontal line across the middle; a square with a diagonal line from top-left to bottom-right; a square with a diagonal line from top-right to bottom-left; a square with a diagonal line from top-left to bottom-right; a square with a diagonal line from top-right to bottom-left; and a square with a diagonal line from top-left to bottom-right.</p>
Arkite	 <p>A vertical sequence of seven sign-writing symbols for the word 'Arkite'. From top to bottom: a square with a diagonal line from top-left to bottom-right; a square with a diagonal line from top-right to bottom-left; a square with a horizontal line across the middle; a square with a diagonal line from top-left to bottom-right; a square with a diagonal line from top-right to bottom-left; a square with a diagonal line from top-left to bottom-right; and a square with a diagonal line from top-right to bottom-left.</p>
arm	 <p>Two sign-writing symbols for the word 'arm'. The first is a vertical line with an upward-pointing arrowhead at the top. The second is a vertical line with a horizontal line extending to the right from its middle, ending in a small arrowhead pointing right.</p>
arm	 <p>Two sign-writing symbols for the word 'arm'. The first is a vertical line with an upward-pointing arrowhead at the top. The second is a vertical line with a horizontal line extending to the right from its middle, ending in a small arrowhead pointing right.</p>

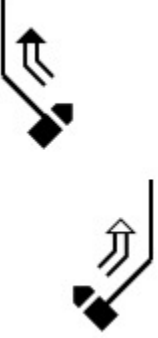



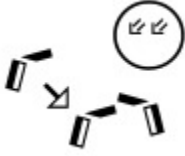
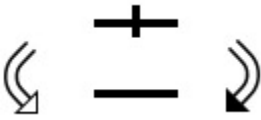

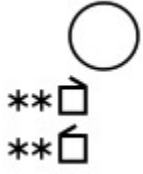
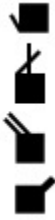

ASL Bible Dictionary

Spoken Word	SignWriting
<p>Armageddon</p>	 <p>The SignWriting for 'Armageddon' is a vertical sequence of eight symbols: a square with a diagonal line, a square with a diagonal line and a small square, a square with a diagonal line and a small square, a square with a diagonal line and a small square, a square with a diagonal line and a small square, a square with a diagonal line and a small square, a square with a diagonal line and a small square, and a square with a diagonal line and a small square.</p>
<p>armor</p>	 <p>The SignWriting for 'armor' consists of two parts. The top part is a circle with a small square below it and an upward-pointing arrow to the right. The bottom part is a horizontal line with two downward-pointing arrows, one on each side.</p>
<p>armor</p>	 <p>The SignWriting for 'armor' is a vertical sequence of five symbols: a square with a diagonal line, a square with a diagonal line and a small square, a square with a diagonal line and a small square, a square with a diagonal line and a small square, and a square with a diagonal line and a small square.</p>
<p>arms</p>	 <p>The SignWriting for 'arms' consists of two parts. The top part is a hand symbol with an upward-pointing arrow. The bottom part is a hand symbol with an upward-pointing arrow and a small square below it.</p>





ASL Bible Dictionary

Spoken Word	SignWriting
arms	
arms	
arms down	
arms up	
army	
army	
Arni	

ASL Bible Dictionary

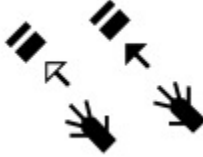
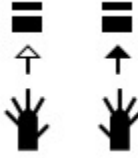
Spoken Word	SignWriting
Arodi	
aroma	
aroma	
arose	
arose	
arose	
around	
around	





ASL Bible Dictionary

Spoken Word	SignWriting
Arphaxad	 <p>A vertical sequence of eight distinct handshapes and movements, starting with a closed fist and ending with a hand held palm up.</p>
arrest	 <p>Two handshapes, each with a horizontal bar above it, moving towards each other and then away from each other.</p>
arrest	 <p>Two handshapes, each with a horizontal bar above it, moving upwards from a palm-up position.</p>
arrest	 <p>Two handshapes, each with a horizontal bar above it, moving towards each other and then away from each other.</p>
arrest	 <p>A handshape with a horizontal bar above it, moving towards a hand held palm up.</p>
arrive	 <p>A handshape moving towards a hand held palm up.</p>
arrive	 <p>A hand held palm up with a circle above it, moving towards a hand held palm up.</p>

ASL Bible Dictionary

Spoken Word	SignWriting
arrive	<p>The signwriting for 'arrive' consists of a circle containing two small squares, followed by a hand icon with an arrow pointing to the right.</p>
arrogant	<p>The signwriting for 'arrogant' features a circle with an upward-pointing arrow above it, containing a star and a vertical line. To the right is a hand icon with an upward-pointing arrow.</p>
arrogant	<p>The signwriting for 'arrogant' shows a circle with a vertical line inside, a hand icon below it, and two upward-pointing arrows to the right.</p>
arrow	<p>The signwriting for 'arrow' depicts a hand icon with an arrow pointing down and to the right, followed by a wavy line and a small circle.</p>
arrow	<p>The signwriting for 'arrow' shows a hand icon with an arrow pointing down and to the right, followed by a small circle and another hand icon.</p>
arrows deflect	<p>The signwriting for 'arrows deflect' includes a hand icon with an arrow pointing down and to the right, followed by a hand icon with an arrow pointing up and to the right.</p>
art	<p>The signwriting for 'art' shows a hand icon with an arrow pointing up and to the right, followed by a hand icon with a wavy arrow pointing down and to the right.</p>
art	<p>The signwriting for 'art' features a hand icon with an arrow pointing up and to the right, followed by a hand icon with a wavy arrow pointing down and to the right.</p>







ASL Bible Dictionary

Spoken Word	SignWriting
<p>Artaxerxes</p>	
<p>Artemas</p>	
<p>Artemis</p>	
<p>artery</p>	

ASL Bible Dictionary

Spoken Word	SignWriting
article	<p>The signwriting for 'article' consists of a square with a diagonal line from the top-left to the bottom-right, followed by a double-lined arrow pointing downwards.</p>
Arvadite	<p>The signwriting for 'Arvadite' is a vertical sequence of seven distinct symbols: a square with a diagonal line, a square with a diagonal line, a square with a diagonal line, a square with a diagonal line, a square with a diagonal line, a square with a diagonal line, and a square with a diagonal line.</p>
as	<p>The signwriting for 'as' consists of a square with a diagonal line, followed by two arrows pointing outwards from the bottom corners.</p>
as	<p>The signwriting for 'as' consists of a circle with two horizontal lines inside, followed by a square with a diagonal line and two arrows pointing outwards from the bottom corners.</p>
as	<p>The signwriting for 'as' consists of a circle with two horizontal lines inside, followed by a square with a diagonal line and two arrows pointing outwards from the bottom corners.</p>
as	<p>The signwriting for 'as' consists of a square with a diagonal line and two arrows pointing outwards from the bottom corners.</p>
as if	<p>The signwriting for 'as if' consists of a square with a diagonal line and two arrows pointing outwards from the bottom corners, followed by a circle with a square attached to its right side.</p>

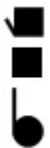
ASL Bible Dictionary

Spoken Word	SignWriting
Asa	
Asaph	
ascend	
ascending	
ascent	
ASD	
Asenath	









ASL Bible Dictionary

Spoken Word	SignWriting
ash	
Ashbel	
Ashbel	
Ashdodites	
Asher	







ASL Bible Dictionary

Spoken Word	SignWriting
ashes	
Ashkelon	
Ashkenaz	
Ashpenaz	

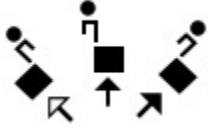
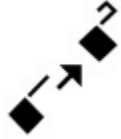



ASL Bible Dictionary

Spoken Word	SignWriting
Ashteroth	
Asia	
Asia	
aside	
ask	
ask	
ask	
ask	

ASL Bible Dictionary

Spoken Word	SignWriting
ask	
ask	
ask	
ask	
ask	
asking	
asl	
ASL example	

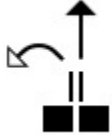
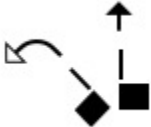

ASL Bible Dictionary

Spoken Word	SignWriting
Assos	
Assyria	
Assyria	
astonished	
astray	
astray	



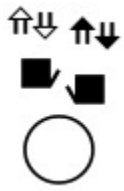

ASL Bible Dictionary

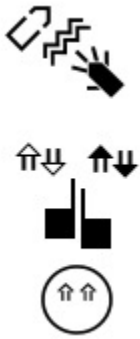
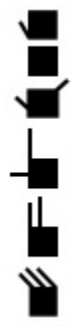
Spoken Word	SignWriting
astro	A vertical sequence of five symbols: a square with a downward-pointing arrow, a solid black square, a square with a downward-pointing arrow, a square with a downward-pointing arrow, and a solid black circle.
astrologers	A sequence of symbols: two pairs of upward and downward arrows, two squares with downward-pointing arrows, a circle, two squares with upward-pointing arrows, and two squares with downward-pointing arrows.

ASL Bible Dictionary

Spoken Word	SignWriting
astrology	
astronomy	
astronomy	
asylum	

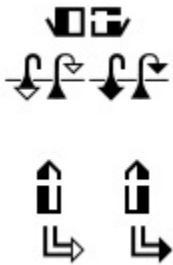

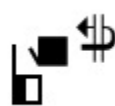



ASL Bible Dictionary

Spoken Word	SignWriting
Athaiah	
Athens	
athletes	
Atlantic	
atmosphere	





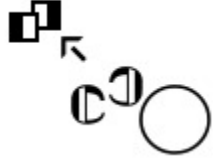
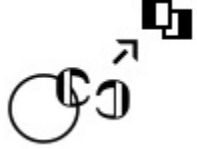

ASL Bible Dictionary

Spoken Word	SignWriting
atones	<p>The SignWriting for 'atones' consists of a vertical sequence of symbols: a square with a diagonal line from top-left to bottom-right, a square with a diagonal line from top-right to bottom-left, a solid circle, a square with a diagonal line from top-left to bottom-right, and a solid square.</p>
attack	<p>The SignWriting for 'attack' consists of a vertical sequence of symbols: a square with a diagonal line from top-left to bottom-right, a square with a diagonal line from top-right to bottom-left, an upward-pointing arrow, and a hand symbol with fingers spread.</p>
Attalia	<p>The SignWriting for 'Attalia' consists of a vertical sequence of symbols: a square with a diagonal line from top-left to bottom-right, a square with a diagonal line from top-right to bottom-left, a square with a diagonal line from top-left to bottom-right, a square with a diagonal line from top-right to bottom-left, a square with a diagonal line from top-left to bottom-right, a square with a diagonal line from top-right to bottom-left, a square with a diagonal line from top-left to bottom-right, and a square with a diagonal line from top-right to bottom-left.</p>
attend	<p>The SignWriting for 'attend' consists of a vertical sequence of symbols: a square with a diagonal line from top-left to bottom-right, a square with a diagonal line from top-right to bottom-left, and a hand symbol with fingers spread.</p>
attention	<p>The SignWriting for 'attention' consists of a vertical sequence of symbols: an upward-pointing arrow, a square with a diagonal line from top-left to bottom-right, a solid circle, a square with a diagonal line from top-right to bottom-left, and another upward-pointing arrow.</p>
attention	<p>The SignWriting for 'attention' consists of a vertical sequence of symbols: a downward-pointing arrow, a square with a diagonal line from top-left to bottom-right, a solid circle, a square with a diagonal line from top-right to bottom-left, and another downward-pointing arrow.</p>
attention	<p>The SignWriting for 'attention' consists of a vertical sequence of symbols: a square with a diagonal line from top-left to bottom-right, a square with a diagonal line from top-right to bottom-left, a square with a diagonal line from top-left to bottom-right, a solid circle, a square with a diagonal line from top-right to bottom-left, and a square with a diagonal line from top-left to bottom-right.</p>



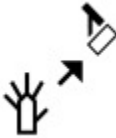
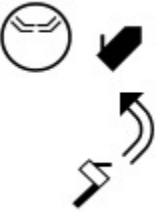
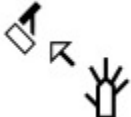

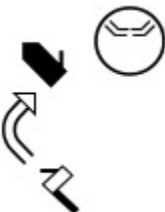

ASL Bible Dictionary

Spoken Word	SignWriting
attention	
attention	
attention	
attention	
attitude	
attract	
attract	
attract	

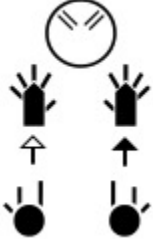
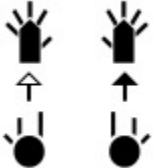
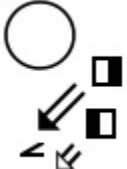

ASL Bible Dictionary

Spoken Word	SignWriting
awaked	
award	
away	
away	
away	
away	
away	
awe	

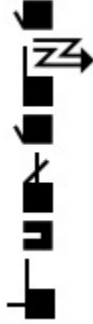

ASL Bible Dictionary

Spoken Word	SignWriting
awesome	
awesome	
awesome	
awesome	
awful	
awful	
ax	
ax	

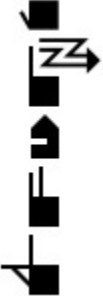



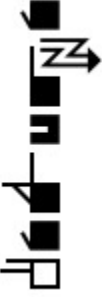

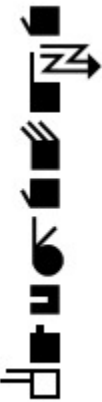
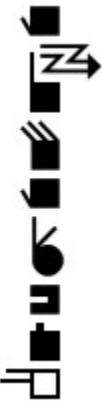
ASL Bible Dictionary

Spoken Word	SignWriting
Azaniah	
Azarel	
Azariah	
Azbuk	



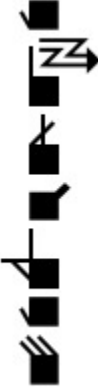

ASL Bible Dictionary

Spoken Word	SignWriting
Azekah	
Azgad	
azmaveth	
Azmaveth	





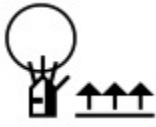

ASL Bible Dictionary

Spoken Word	SignWriting
Azor	
Azotus	
Azrikam	
Azzur	
B	
BA	

ASL Bible Dictionary

Spoken Word	SignWriting
Baal	
Baalhanan	
Baana	
Baanah	
babble	
babbling	







ASL Bible Dictionary

Spoken Word	SignWriting
Babel	
babies	
baby	
Babylon	
Babylon	
Babylonia	

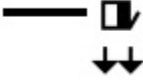
ASL Bible Dictionary

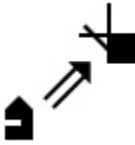
Spoken Word	SignWriting
bachelors	<p>The SignWriting for 'bachelors' is a vertical sequence of symbols: a solid black square at the bottom, followed by a square with a diagonal line from top-left to bottom-right, a solid black circle, a square with a horizontal line through its center, a square with a vertical line through its center, a square with a horizontal line through its center, a square with a vertical line through its center, a square with a horizontal line through its center, and a solid black triangle pointing upwards at the top.</p>
back	<p>The SignWriting for 'back' consists of a square with a diagonal line from top-left to bottom-right, a solid black circle, a square with a horizontal line through its center, a square with a vertical line through its center, and a solid black triangle pointing upwards.</p>
back	<p>The SignWriting for 'back' consists of a solid black triangle pointing upwards, a square with a diagonal line from top-left to bottom-right, and a square with a horizontal line through its center.</p>
back	<p>The SignWriting for 'back' consists of a solid black triangle pointing upwards, a square with a diagonal line from top-left to bottom-right, and a square with a horizontal line through its center.</p>
back	<p>The SignWriting for 'back' consists of a solid black triangle pointing upwards, a square with a diagonal line from top-left to bottom-right, and a solid black triangle pointing downwards.</p>
back	<p>The SignWriting for 'back' consists of a square with a diagonal line from top-left to bottom-right, a square with a horizontal line through its center, a square with a vertical line through its center, and a solid black triangle pointing upwards.</p>
back	<p>The SignWriting for 'back' consists of a square with a diagonal line from top-left to bottom-right, a square with a horizontal line through its center, and a solid black triangle pointing upwards.</p>



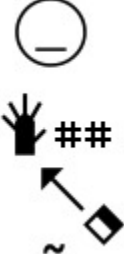

ASL Bible Dictionary

Spoken Word	SignWriting
back	
back & forth	
back up	
back-heaven	
background	
backhand	
backslider	
backstab	



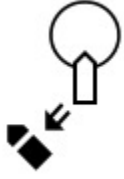

ASL Bible Dictionary

Spoken Word	SignWriting
bacon	The SignWriting for the word 'bacon' is a vertical sequence of five symbols: a triangle pointing up, a square, a circle, another circle, and a square with a diagonal line.



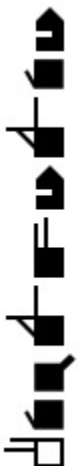

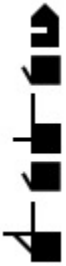
ASL Bible Dictionary

Spoken Word	SignWriting
bad	
bag	
bags	
bail	
Bakbuk	

ASL Bible Dictionary

Spoken Word	SignWriting
Bakbukiah	
baker	
Balaam	
Balak	
ball	

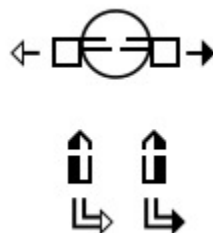



ASL Bible Dictionary

Spoken Word	SignWriting
ballet	
balm	
bandage	
bandits	
Bani	
Banner	



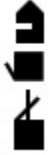



ASL Bible Dictionary

Spoken Word	SignWriting
banquet	<p>The signwriting for 'banquet' consists of a circle with a hand sign above it, followed by a hand sign with a triangle, and a hand sign with a triangle and a square. Below this is a hand sign with a triangle and a square, followed by a hand sign with a triangle and a square, and a hand sign with a triangle and a square.</p>
banquets	<p>The signwriting for 'banquets' consists of a circle with a hand sign above it, followed by a hand sign with a triangle, and a hand sign with a triangle and a square. Below this is a hand sign with a triangle and a square, followed by a hand sign with a triangle and a square, and a hand sign with a triangle and a square.</p>
Baptist	<p>The signwriting for 'Baptist' consists of a hand sign with a triangle and a square, followed by a hand sign with a triangle and a square, and a hand sign with a triangle and a square. Below this is a hand sign with a triangle and a square, followed by a hand sign with a triangle and a square, and a hand sign with a triangle and a square.</p>
baptize	<p>The signwriting for 'baptize' consists of a hand sign with a triangle and a square, followed by a hand sign with a triangle and a square, and a hand sign with a triangle and a square. Below this is a hand sign with a triangle and a square, followed by a hand sign with a triangle and a square, and a hand sign with a triangle and a square.</p>
baptize	<p>The signwriting for 'baptize' consists of a hand sign with a triangle and a square, followed by a hand sign with a triangle and a square, and a hand sign with a triangle and a square. Below this is a hand sign with a triangle and a square, followed by a hand sign with a triangle and a square, and a hand sign with a triangle and a square.</p>
baptize	<p>The signwriting for 'baptize' consists of a hand sign with a triangle and a square, followed by a hand sign with a triangle and a square, and a hand sign with a triangle and a square. Below this is a hand sign with a triangle and a square, followed by a hand sign with a triangle and a square, and a hand sign with a triangle and a square.</p>





ASL Bible Dictionary

Spoken Word	SignWriting
baptizing	
bar	
bar	
Barabbas	
Barachiah	



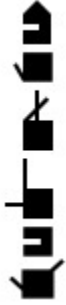
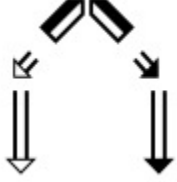

ASL Bible Dictionary

Spoken Word	SignWriting
Barak	
barely	
bark	
bark	
barkley	
Barkos	

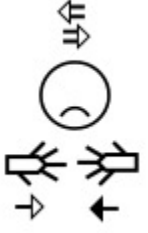
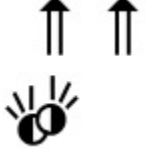

ASL Bible Dictionary

Spoken Word	SignWriting
barley	
barn	
barn	
Barnabas	
Barnabas	



ASL Bible Dictionary

Spoken Word	SignWriting
Barnabas	
barns	
barren	
bars	
bars	

ASL Bible Dictionary

Spoken Word	SignWriting
<p>Barsabbas</p>	
<p>Bartholomew</p>	
<p>Bartimaeus</p>	

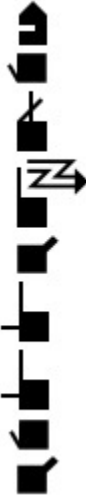



ASL Bible Dictionary

Spoken Word	SignWriting
Baruch	
Barzillai	
base	
Bashan	



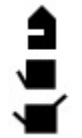
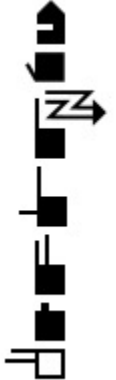

ASL Bible Dictionary

Spoken Word	SignWriting
Batch	<p>The sign for 'Batch' is written vertically. It starts with a downward arrow, followed by a series of horizontal lines, a curved line, and ends with a square.</p>
Batch	<p>The sign for 'Batch' is written vertically. It starts with a downward arrow, followed by a series of horizontal lines, a curved line, and ends with a square.</p>
bath	<p>The sign for 'bath' consists of two diamond shapes, each with a small circle below it. Below the diamonds are two sets of arrows: the left set has a downward arrow, an upward arrow, and a downward arrow; the right set has a downward arrow, an upward arrow, and a downward arrow.</p>
bathroom	<p>The sign for 'bathroom' starts with a square, followed by two sets of arrows: the first set has a rightward arrow and a downward arrow; the second set has a rightward arrow and a downward arrow.</p>
Bathsheba	<p>The sign for 'Bathsheba' is written vertically. It starts with a downward arrow, followed by a series of horizontal lines, a square, another series of horizontal lines, another square, and ends with a downward arrow.</p>
batter	<p>The sign for 'batter' starts with a downward arrow, followed by a series of curved arrows, and ends with a hand shape.</p>
battle	<p>The sign for 'battle' starts with a downward arrow, followed by a series of curved arrows, and ends with a hand shape.</p>



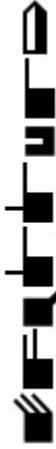
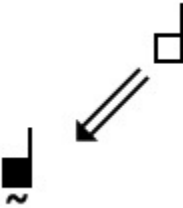

ASL Bible Dictionary

Spoken Word	SignWriting
battle	
bawl out	
Bay	
Bazluth	
BC	

ASL Bible Dictionary

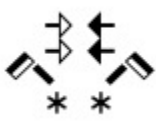
Spoken Word	SignWriting
bdellium	
be-with-me	
Beach	
beams	
beams	
bear	

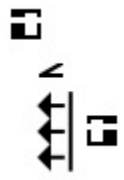

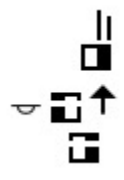
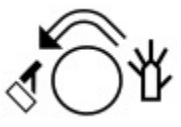

ASL Bible Dictionary

Spoken Word	SignWriting
bear-witness	
beast	
beat	
beat	
beat	
beat	
beat	
beautiful	



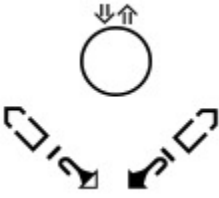

ASL Bible Dictionary

Spoken Word	SignWriting
beautiful	<p>The SignWriting for 'beautiful' consists of three main components. At the top, there are two curved arrows pointing downwards and outwards from a central point. Below this, there is a circle with two hands on either side, palms facing outwards. Underneath the circle, there are two hands with fingers spread, palms facing each other. At the bottom, there is a circle containing the Hebrew characters 'יה' (Yeh) and two hands with fingers spread, palms facing each other.</p>
beauty	<p>The SignWriting for 'beauty' consists of two main components. The top component features a central circle with two hands on either side, palms facing outwards, and two curved arrows above it pointing downwards and outwards. The bottom component features a central circle with two hands on either side, palms facing each other, and two hands with fingers spread, palms facing each other, positioned below the circle.</p>
Bebai	<p>The SignWriting for 'Bebai' is a vertical sequence of seven downward-pointing arrows, each with a small horizontal bar at its base, creating a staircase-like effect.</p>
because	<p>The SignWriting for 'because' consists of three main components. On the left, there is a circle with two hands on either side, palms facing each other. To the right of the circle, there are two hands with fingers spread, palms facing each other, and a small square symbol below them.</p>
because	<p>The SignWriting for 'because' consists of three main components. On the left, there is a circle with two hands on either side, palms facing each other. To the right of the circle, there are two hands with fingers spread, palms facing each other, and a small square symbol below them.</p>
because	<p>The SignWriting for 'because' consists of three main components. On the left, there is a circle with two hands on either side, palms facing each other. To the right of the circle, there are two hands with fingers spread, palms facing each other, and a small square symbol below them.</p>
because	<p>The SignWriting for 'because' consists of three main components. On the left, there is a circle with two hands on either side, palms facing each other. To the right of the circle, there are two hands with fingers spread, palms facing each other, and a small square symbol below them.</p>

ASL Bible Dictionary

Spoken Word	SignWriting
Becher	
beckon	
become	
bed	
bed	
Bedad	

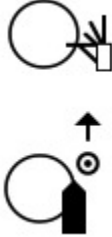



ASL Bible Dictionary

Spoken Word	SignWriting
Bedouin	 <p>The signwriting for 'Bedouin' consists of a vertical sequence of symbols: a downward-pointing arrow, a horizontal line, a circle, a square, a triangle, and a hand symbol with fingers spread.</p>
bedrock	 <p>The signwriting for 'bedrock' consists of a vertical sequence of symbols: a downward-pointing arrow, a horizontal line, a circle, a square, a triangle, a circle, a square, and a hand symbol with fingers spread.</p>
bee	 <p>The signwriting for 'bee' consists of two parts. The top part shows a circle with a hand symbol (fingers spread) positioned to its right. The bottom part shows a circle with a hand symbol (fingers spread) positioned to its right, and a small circle with a dot in the center positioned above the hand symbol.</p>
Beeri	 <p>The signwriting for 'Beeri' consists of a vertical sequence of symbols: a downward-pointing arrow, a horizontal line, a circle, a square, a triangle, and a hand symbol with fingers spread.</p>





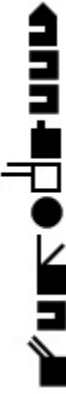

ASL Bible Dictionary

Spoken Word	SignWriting
Beerlahairoi	 A vertical sequence of 14 distinct SignWriting symbols representing the word "Beerlahairoi". From top to bottom, the symbols are: a triangle pointing up, a vertical line, a vertical line with a horizontal bar to the right, a vertical line with a horizontal bar to the right, a vertical line with a horizontal bar to the right, a vertical line with a horizontal bar to the right, a vertical line with a horizontal bar to the right, a vertical line with a horizontal bar to the right, a vertical line with a horizontal bar to the right, a vertical line with a horizontal bar to the right, a vertical line with a horizontal bar to the right, a vertical line with a horizontal bar to the right, a vertical line with a horizontal bar to the right, and a vertical line with a horizontal bar to the right.

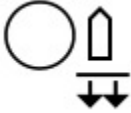

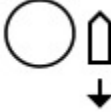
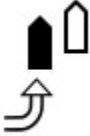
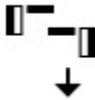

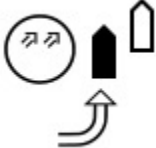

ASL Bible Dictionary

Spoken Word	SignWriting
Beeroth	
Beersheba	
bees	
Beethoven	
before	

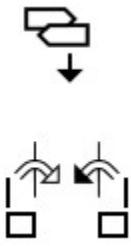
ASL Bible Dictionary

Spoken Word	SignWriting
before	
before	
before	
before	
before	
before	
before	
before	
before God	

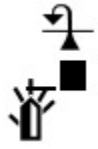
ASL Bible Dictionary

Spoken Word	SignWriting
beforehand	
beg	
beg	
beg	
beg	
began	
beget	







ASL Bible Dictionary

Spoken Word	SignWriting
beggar	<p>The sign for 'beggar' is composed of three parts: a hand sign with fingers 2, 3, and 4 extended and the thumb tucked, with a downward arrow; two separate hand signs, each consisting of a square with a downward arrow.</p>
beginning	<p>The sign for 'beginning' is composed of two parts: a hand sign with fingers 2, 3, and 4 extended and the thumb tucked, with an upward arrow; a hand sign with a square and a downward arrow.</p>
begot	<p>The sign for 'begot' is composed of two parts: a hand sign with fingers 2, 3, and 4 extended and the thumb tucked, with two asterisks and a circle; two solid black circles with three fingers extended from each.</p>
begotten	<p>The sign for 'begotten' is composed of two parts: a hand sign with fingers 2, 3, and 4 extended and the thumb tucked, with a square and an upward arrow; a hand sign with a sun-like symbol and an asterisk.</p>
behead	<p>The sign for 'behead' is a hand sign with fingers 2, 3, and 4 extended and the thumb tucked, with a downward arrow.</p>
behind	<p>The sign for 'behind' is a hand sign with fingers 2, 3, and 4 extended and the thumb tucked, with a square and a U-shaped arrow.</p>
behind	<p>The sign for 'behind' is a hand sign with fingers 2, 3, and 4 extended and the thumb tucked, with a square and a U-shaped arrow, followed by a downward arrow.</p>

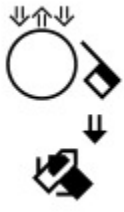







ASL Bible Dictionary

Spoken Word	SignWriting
behind	<p>The sign is represented by a square with a tilde (~) to its left, a square with a vertical line above it to its right, and a square with a curved arrow pointing right below it.</p>
being	<p>The sign is represented by two squares, each with a downward-pointing arrow below it.</p>
being	<p>The sign is represented by two squares, each with a downward-pointing arrow below it.</p>
being	<p>The sign is represented by two squares, each with a downward-pointing arrow below it.</p>
beings	<p>The sign is represented by a square with a curved arrow pointing right to its left, a square with a vertical line above it, and a square with a curved arrow pointing right to its right.</p>
Bela	<p>The sign is represented by a vertical sequence of symbols: a square with a vertical line above it, a horizontal line, a square with a vertical line above it, and a square with a vertical line above it.</p>
Belah	<p>The sign is represented by a vertical sequence of symbols: a square with a vertical line above it, a horizontal line, a square with a vertical line above it, a square with a vertical line above it, and a square with a vertical line above it.</p>
believe	<p>The sign is represented by a circle, a square with a vertical line above it, a square with a vertical line above it, and a square with a vertical line above it.</p>

ASL Bible Dictionary

Spoken Word	SignWriting
believe	
believer	
believers	
belittle	
belly	
belong	
belong	

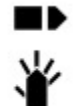



ASL Bible Dictionary

Spoken Word	SignWriting
belong	
belong	
belong	
belong	
belong	
belongs	
belongs	
below	
below	
below	



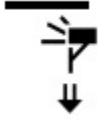

ASL Bible Dictionary

Spoken Word	SignWriting
Belshazzar	<p>The SignWriting for 'Belshazzar' is a vertical sequence of signs. From top to bottom: a sign for 'B' (a vertical line with a hook), a sign for 'E' (a vertical line with a hook), a sign for 'L' (a vertical line with a hook), a sign for 'S' (a vertical line with a hook), a sign for 'H' (a vertical line with a hook), a sign for 'A' (a vertical line with a hook), a sign for 'Z' (a vertical line with a hook), a sign for 'A' (a vertical line with a hook), a sign for 'R' (a vertical line with a hook), and a final sign for 'Z' (a vertical line with a hook).</p>
Belshazzar	<p>The SignWriting for 'Belshazzar' is a vertical sequence of signs. From top to bottom: a sign for 'B' (a vertical line with a hook), a sign for 'E' (a vertical line with a hook), a sign for 'L' (a vertical line with a hook), a sign for 'S' (a vertical line with a hook), a sign for 'H' (a vertical line with a hook), a sign for 'A' (a vertical line with a hook), a sign for 'Z' (a vertical line with a hook), a sign for 'A' (a vertical line with a hook), a sign for 'R' (a vertical line with a hook), and a final sign for 'Z' (a vertical line with a hook).</p>
belt	<p>The SignWriting for 'belt' is a vertical sequence of signs. From top to bottom: a sign for 'B' (a vertical line with a hook), a sign for 'E' (a vertical line with a hook), a sign for 'L' (a vertical line with a hook), and a final sign for 'T' (a vertical line with a hook).</p>
Belteshazzar	<p>The SignWriting for 'Belteshazzar' is a vertical sequence of signs. From top to bottom: a sign for 'B' (a vertical line with a hook), a sign for 'E' (a vertical line with a hook), a sign for 'L' (a vertical line with a hook), a sign for 'T' (a vertical line with a hook), a sign for 'E' (a vertical line with a hook), a sign for 'S' (a vertical line with a hook), a sign for 'H' (a vertical line with a hook), a sign for 'A' (a vertical line with a hook), a sign for 'Z' (a vertical line with a hook), a sign for 'A' (a vertical line with a hook), a sign for 'R' (a vertical line with a hook), and a final sign for 'Z' (a vertical line with a hook).</p>



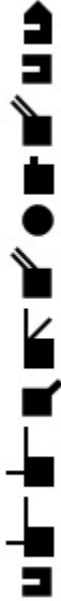

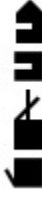
ASL Bible Dictionary

Spoken Word	SignWriting
Benammi	
bend	
benefit	
benefit	
Beninu	

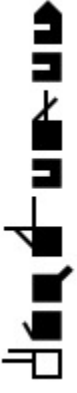

ASL Bible Dictionary

Spoken Word	SignWriting
Bentonville	 <p>The SignWriting for 'Bentonville' is a vertical sequence of signs: B, E, N, T, O, N, V, I, L, L, E.</p>
Beor	 <p>The SignWriting for 'Beor' is a vertical sequence of signs: B, E, O, R.</p>
Bera	 <p>The SignWriting for 'Bera' is a vertical sequence of signs: B, E, R, A.</p>
Berea	 <p>The SignWriting for 'Berea' is a vertical sequence of signs: B, E, R, E, A.</p>

ASL Bible Dictionary

Spoken Word	SignWriting
Bered	
Berekiah	
Berekiah	
Beriah	

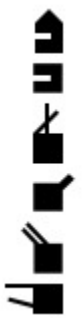
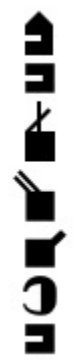
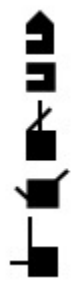



ASL Bible Dictionary

Spoken Word	SignWriting
Beriah	
Bering	
Bernice	
beryl	
Besai	





ASL Bible Dictionary

Spoken Word	SignWriting
beseech	<p>The signwriting for 'beseech' consists of two square boxes, each with an upward-pointing arrow. Below these is a downward-pointing arrow, and at the bottom is a stylized icon of two open doors.</p>
besiege	<p>The signwriting for 'besiege' features a horizontal line at the top, followed by two square boxes with asterisks. Below this is a diagram of four hands in a square formation, with curved arrows pointing inward from the top and outward from the bottom.</p>
Besodeiah	<p>The signwriting for 'Besodeiah' is a vertical sequence of symbols: a downward arrow, a series of vertical bars, a circle, a horizontal line, another circle, and a stylized hand icon.</p>
best	<p>The signwriting for 'best' shows a hand icon pointing to a circle, followed by an arrow pointing to a square box.</p>
Beth-	<p>The signwriting for 'Beth-' includes a downward arrow, a series of vertical bars, a square box, a horizontal line, and a rightward-pointing arrow.</p>







ASL Bible Dictionary

Spoken Word	SignWriting
Bethany	
Bethel	
Betheln	
Bethesda	
Bethlehem	

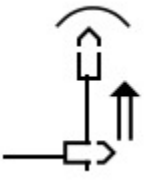
ASL Bible Dictionary

Spoken Word	SignWriting
Bethlehem-fs	
Bethphage	
Bethsaida	
Bethuel	

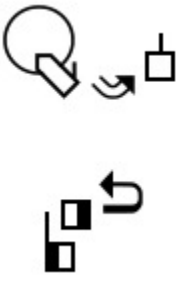

ASL Bible Dictionary

Spoken Word	SignWriting
betimes	
betray	
betrayer	
better	
better-off	
between	
between	



ASL Bible Dictionary

Spoken Word	SignWriting
beware	

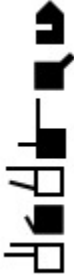
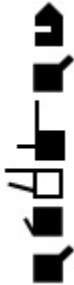



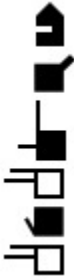

ASL Bible Dictionary

Spoken Word	SignWriting
Bigtha	
Bigthana	
Bigvai	
Bilgah	
Bilgai	



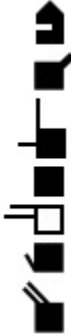

ASL Bible Dictionary

Spoken Word	SignWriting
Bilhah	
Bilhah	
Bilhan	
bilingual	

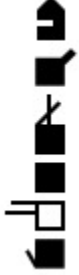
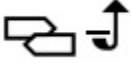

ASL Bible Dictionary

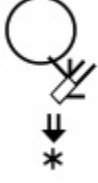
Spoken Word	SignWriting
Bill	
billion	
Bilshan	
bind	
bind	
Binnui	
bird	





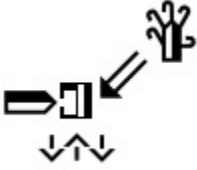

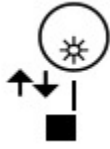
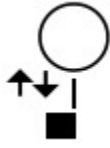

ASL Bible Dictionary

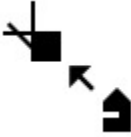
Spoken Word	SignWriting
birds	
Birsha	
birth	
birthday	
birthday	
Bitar	
bite	

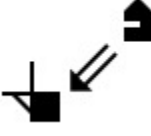

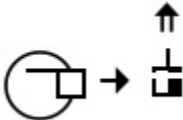
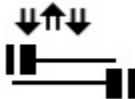

ASL Bible Dictionary

Spoken Word	SignWriting
bite	
bite-nails	
Bithynia	
bitter	
bitter	



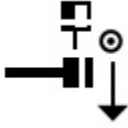
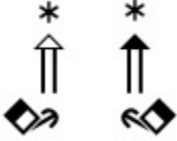

ASL Bible Dictionary

Spoken Word	SignWriting
bk	
bk	
bk	
bk	
black	
blackest	
blah-blah	
blah-blah	
blame	
blame	





ASL Bible Dictionary

Spoken Word	SignWriting
blame-self	
blanket	
blaspheme	
blasphemes	
blasphemy	



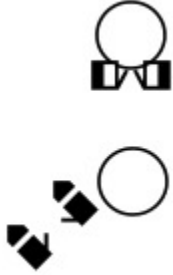
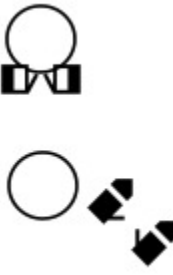
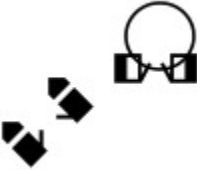

ASL Bible Dictionary

Spoken Word	SignWriting
blasphemy	
blast	
Blastus	
bleach	
bless	



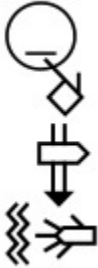
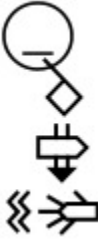

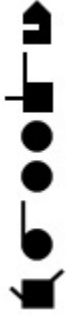



ASL Bible Dictionary

Spoken Word	SignWriting
bless	
bless-God	
blesses	
blesses	
blesses	
blesses-God	
blessings	







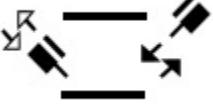

ASL Bible Dictionary

Spoken Word	SignWriting
blood	
blood	
Bloodshed	
bloody	
blow-away	
blow-away	

ASL Bible Dictionary

Spoken Word	SignWriting
blow-up	
blue	
blurry	
blurt	
board	
board	
board	
boast	
boast	

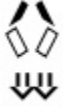
ASL Bible Dictionary

Spoken Word	SignWriting
boat	
boat	
boat	
boat	
boat	
boats	
boats	
boats	
Boaz	

ASL Bible Dictionary

Spoken Word	SignWriting
Boaz	<p>The SignWriting for 'Boaz' consists of a vertical sequence of symbols: a house-like shape with an upward arrow, a solid black circle, a solid black square, and a horizontal line with a zigzag arrow pointing to the right.</p>
bodies	<p>The SignWriting for 'bodies' consists of two columns of symbols. The left column has a horizontal rectangle with a downward arrow, a downward arrow, and a solid black asterisk. The right column has a horizontal rectangle with a downward arrow, a downward arrow, and a solid black asterisk.</p>
body	<p>The SignWriting for 'body' consists of two columns of symbols. The left column has a tilted rectangle with a downward arrow, a downward arrow, and a solid black asterisk. The right column has a tilted rectangle with a downward arrow, a downward arrow, and a solid black asterisk.</p>





ASL Bible Dictionary

Spoken Word	SignWriting
boil	<p>The signwriting for 'boil' consists of four vertically stacked symbols: a circle with a horizontal line across the top, a solid black square with a right-pointing arrow, a wavy line representing steam, and a hand with fingers spread and a curved arrow below it.</p>
bolt	<p>The signwriting for 'bolt' consists of two vertically stacked symbols: a hand with fingers spread and three arrows pointing upwards and to the right, and a hand with fingers spread, a star above it, and a right-pointing arrow below it.</p>
bolts	<p>The signwriting for 'bolts' consists of a single vertically stacked symbol: a hand with fingers spread, a right-pointing arrow above it, a solid black circle to the right, a horizontal line, a solid black square, and another solid black square below it.</p>
bomb-diggetty	<p>The signwriting for 'bomb-diggetty' consists of two vertically stacked symbols: a hand with fingers spread, a circle above it, and two arrows pointing downwards and to the left, and a hand with fingers spread, a star above it, and a wavy line below it.</p>
bombdiggetty	<p>The signwriting for 'bombdiggetty' consists of two vertically stacked symbols: a hand with fingers spread, a circle above it, and two arrows pointing downwards and to the left, and a hand with fingers spread, a star above it, and a wavy line below it.</p>

ASL Bible Dictionary

Spoken Word	SignWriting
bombdiggety	<p>The signwriting for 'bombdiggety' consists of three distinct signs. The first sign shows a hand with fingers spread, moving towards a circle. The second sign is a circle with a horizontal line through its center. The third sign shows a hand with fingers spread, moving towards a circle with a wavy line below it, and a small asterisk-like symbol to the left.</p>
bond	<p>The signwriting for 'bond' consists of two signs. The first sign shows a hand with fingers spread, moving towards a circle. The second sign shows a hand with fingers spread, moving towards a circle with a horizontal line through its center.</p>
bond	<p>The signwriting for 'bond' consists of three signs. The first sign is a hand with fingers spread, moving towards a circle. The second sign is a hand with fingers spread, moving towards a circle with a horizontal line through its center. The third sign is a hand with fingers spread, moving towards a circle with a horizontal line through its center.</p>
bondage	<p>The signwriting for 'bondage' consists of two signs. The first sign shows a hand with fingers spread, moving towards a circle with a horizontal line through its center. The second sign shows a hand with fingers spread, moving towards a circle with a horizontal line through its center.</p>
bone	<p>The signwriting for 'bone' consists of two signs. The first sign shows a hand with fingers spread, moving towards a circle with a horizontal line through its center. The second sign shows a hand with fingers spread, moving towards a circle with a horizontal line through its center.</p>
bonfire	<p>The signwriting for 'bonfire' consists of three signs. The first sign is a hand with fingers spread, moving towards a circle with a horizontal line through its center. The second sign is a hand with fingers spread, moving towards a circle with a horizontal line through its center. The third sign is a hand with fingers spread, moving towards a circle with a horizontal line through its center.</p>



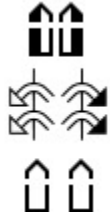





ASL Bible Dictionary

Spoken Word	SignWriting
book	
book	
book	
book	
books	
books	



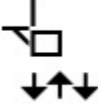

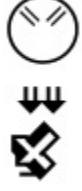

ASL Bible Dictionary

Spoken Word	SignWriting
border	<p>The signwriting for 'border' consists of a vertical sequence of symbols: a downward-pointing arrow, a solid black circle, a square with a diagonal line from the top-left to the bottom-right, a horizontal line, another solid black circle, another square with a diagonal line, and a final downward-pointing arrow.</p>
bore	<p>The signwriting for 'bore' features a circle containing the number '1' on the left, followed by a square with a diagonal line, and a hand symbol with fingers spread on the right.</p>
born	<p>The signwriting for 'born' shows a hand symbol on the left and a square with a diagonal line on the right, with an upward-pointing arrow positioned between them.</p>
borrow	<p>The signwriting for 'borrow' includes a hand symbol on the left, a square with a diagonal line in the center, and a hand symbol on the right with a curved arrow pointing from the right hand towards the square.</p>
borrow	<p>The signwriting for 'borrow' features a hand symbol on the left, a square with a diagonal line in the center, and a hand symbol on the right with a curved arrow pointing from the right hand towards the square.</p>
borrow	<p>The signwriting for 'borrow' shows a square with a diagonal line in the center, a hand symbol on the right, and a curved arrow pointing from the right hand towards the square.</p>
borrow	<p>The signwriting for 'borrow' consists of a square with a diagonal line in the center, a hand symbol on the right, and a curved arrow pointing from the right hand towards the square.</p>
Bose	<p>The signwriting for 'Bose' is a vertical sequence of symbols: a downward-pointing arrow, a solid black circle, a square with a diagonal line, a horizontal line, another solid black circle, another square with a diagonal line, and a final downward-pointing arrow.</p>







ASL Bible Dictionary

Spoken Word	SignWriting
Bose	
boss	
boss	
Boston	
both	
both-of-us	
both-of-you	
bother	
bother	
bother	

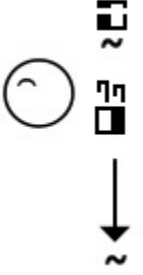

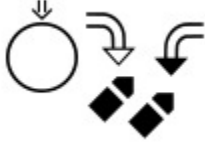

ASL Bible Dictionary

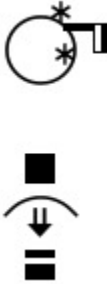
Spoken Word	SignWriting
bothers	
bottle	
boulder	
bound	
bounty	
bove	
Bove	



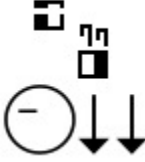

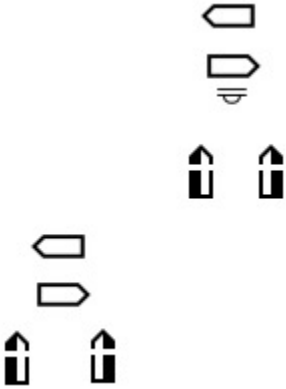

ASL Bible Dictionary

Spoken Word	SignWriting
bow	
bow	
bow	
bow	
bow-down	
bow-head	
bow-head	

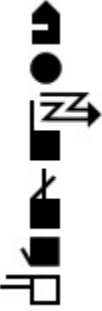
ASL Bible Dictionary

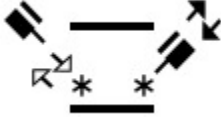
Spoken Word	SignWriting
bowl	
bows	
box	
box	
boxes	
boy	
boys	



ASL Bible Dictionary

Spoken Word	SignWriting
Bozrah	
BP	
bracelet	
brag	
brag	
brag	
braid	

ASL Bible Dictionary

Spoken Word	SignWriting
braids	<p>The SignWriting for 'braids' consists of a vertical sequence of symbols: a house-like shape, a vertical line with a crossbar, a square, a square with a diagonal line, a square with a diagonal line, a circle, and a square.</p>
Braidwood	<p>The SignWriting for 'Braidwood' consists of a vertical sequence of symbols: a house-like shape, a vertical line with a crossbar, a square, a square with a diagonal line, a square with a diagonal line, a circle, a circle, a circle, a circle, and a square.</p>
bramble	<p>The SignWriting for 'bramble' consists of a vertical sequence of symbols: a house-like shape, a vertical line with a crossbar, a square, a square with a diagonal line, a square with a diagonal line, a house-like shape, a vertical line with a crossbar, and a square.</p>
branch	<p>The SignWriting for 'branch' consists of a vertical line with a crossbar, a vertical line with a crossbar, a vertical line with a crossbar, and a vertical line with a crossbar.</p>

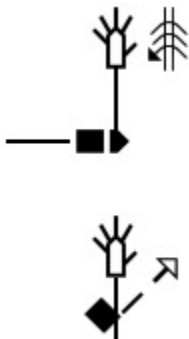
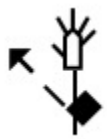

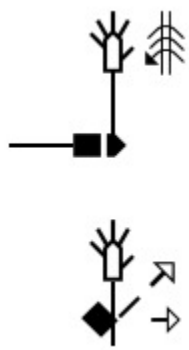



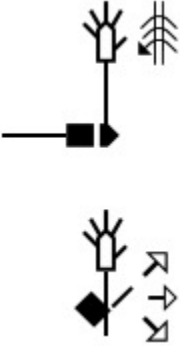
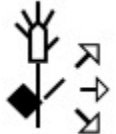
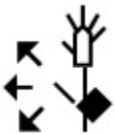
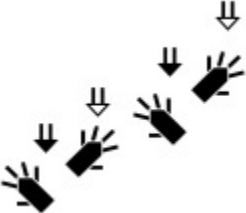
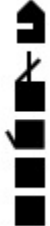
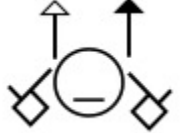

ASL Bible Dictionary

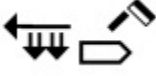
Spoken Word	SignWriting
branch	 <p>The signwriting for 'branch' in the first row consists of two parts. The top part shows a hand with fingers spread, palm facing left, with a vertical line extending downwards from the center. To the right of this line is a small, stylized tree icon. The bottom part shows a hand with the index finger pointing up and slightly to the right, palm facing left. A small black diamond is positioned below the hand, and a small arrow points from the diamond towards the hand.</p>
branch	 <p>The signwriting for 'branch' in the second row shows a hand with fingers spread, palm facing left, with a vertical line extending downwards from the center. To the right of this line is a small, stylized tree icon. A small arrow points from the hand towards the tree icon.</p>
branch	 <p>The signwriting for 'branch' in the third row consists of two parts. The top part shows a hand with fingers spread, palm facing left, with a vertical line extending downwards from the center. To the right of this line is a small, stylized tree icon. Below the hand is a small black diamond, and a small arrow points from the diamond towards the hand. The bottom part shows a hand with the index finger pointing up and slightly to the right, palm facing left. A small black diamond is positioned below the hand, and a small arrow points from the diamond towards the hand.</p>
branches	 <p>The signwriting for 'branches' in the fourth row consists of two parts. The top part shows a hand with fingers spread, palm facing left, with a vertical line extending downwards from the center. To the right of this line is a small, stylized tree icon. The bottom part shows a hand with the index finger pointing up and slightly to the right, palm facing left. A small black diamond is positioned below the hand, and a small arrow points from the diamond towards the hand.</p>



ASL Bible Dictionary

Spoken Word	SignWriting
branches	
branches	
branches	
branches-road	
brass	
brat	





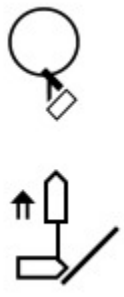
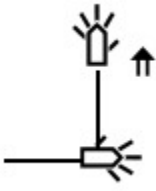
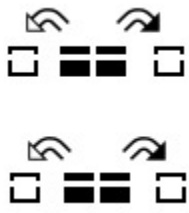
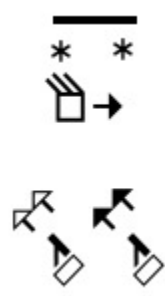
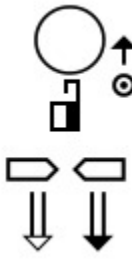

ASL Bible Dictionary

Spoken Word	SignWriting
Bread	
bread	
bread	
bread	  
bread-loaf	 
break	



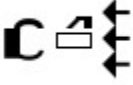
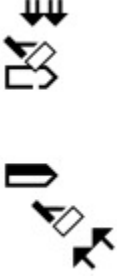

ASL Bible Dictionary

Spoken Word	SignWriting
breakfast	
breaking-of-the-day	
breaks	
breastfeed	
breastplate	
breasts	

ASL Bible Dictionary

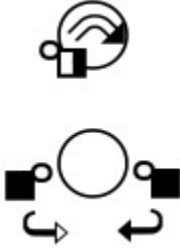
Spoken Word	SignWriting
Brian	
Brian	
bribe	
bribe	
bricks	
bride	
bride	

ASL Bible Dictionary

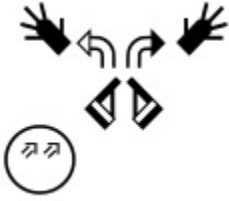
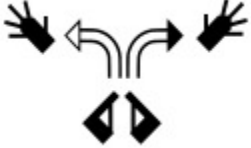
Spoken Word	SignWriting
<p style="text-align: center;">bridle</p>	
<p style="text-align: center;">bridle</p>	
<p style="text-align: center;">brief</p>	
<p style="text-align: center;">brief</p>	
<p style="text-align: center;">bright</p>	
<p style="text-align: center;">bright</p>	

ASL Bible Dictionary

Spoken Word	SignWriting
British	<p>The sign for 'British' is written vertically. It starts with a downward arrow, followed by a series of downward strokes with various shapes at their ends, including a small square at the bottom.</p>
Broad	<p>The sign for 'Broad' is written vertically. It begins with a downward arrow, followed by several downward strokes with different shapes, ending with a small circle.</p>
broccoli	<p>The sign for 'broccoli' is written vertically. It starts with a downward arrow, followed by a series of downward strokes with various shapes, including a small square at the bottom.</p>
broke	<p>The sign for 'broke' is written vertically. It features a circle at the top, followed by a downward stroke with a small square at the end, and a downward arrow to the right.</p>
broke	<p>The sign for 'broke' is written vertically. It features a circle at the top, followed by a downward stroke with a small square at the end, and a downward arrow to the right.</p>
broken	<p>The sign for 'broken' is written vertically. It consists of three downward strokes, each with a small square at the end, and two curved arrows above the middle stroke pointing outwards.</p>





ASL Bible Dictionary

Spoken Word	SignWriting
broken	<p>The sign for 'broken' is composed of three parts. The top part consists of two square boxes, each with a curved arrow above it pointing towards the center. Below this is a horizontal bar with two thick black segments. The bottom part shows two hands with fingers spread, positioned on either side of a horizontal bar with two thick black segments, with small arrows pointing towards the center.</p>
bronze	<p>The sign for 'bronze' is a vertical sequence of symbols. From top to bottom: a square with a small triangle on top, a square with a diagonal line, a solid black circle, a square with a diagonal line, a square with a zigzag line, and a solid black square.</p>
brook	<p>The sign for 'brook' is a vertical sequence of symbols. From top to bottom: a square with a small triangle on top, a square with a diagonal line, a solid black circle, another solid black circle, and a square with a diagonal line.</p>
Brooklyn	<p>The sign for 'Brooklyn' is a vertical sequence of symbols. From top to bottom: a square with a small triangle on top, a square with a diagonal line, a solid black circle, another solid black circle, a square with a diagonal line, a square with a diagonal line, and a solid black square.</p>

ASL Bible Dictionary

Spoken Word	SignWriting
brother	<p>The signwriting for 'brother' consists of a circle on the left, a square on the right, and a diamond on the right. Arrows indicate the movement of the hands: one arrow points from the circle to the square, and another points from the square to the diamond.</p>
brothers	<p>The signwriting for 'brothers' is similar to 'brother' but includes an additional arrow pointing from the diamond back towards the square, indicating a return movement.</p>
brothers	<p>The signwriting for 'brothers' is similar to the previous entry but includes an additional arrow pointing from the diamond towards the circle, indicating a return movement to the starting point.</p>
brought	<p>The signwriting for 'brought' consists of two diamonds. Arrows indicate the movement of the hands: one arrow points from the left diamond to the right diamond, and another points from the right diamond back to the left diamond.</p>
brown	<p>The signwriting for 'brown' consists of a circle on the left, a square on the right, and a diamond on the right. Arrows indicate the movement of the hands: one arrow points from the circle to the square, and another points from the square to the diamond.</p>
BS	<p>The signwriting for 'BS' consists of a single diamond with an arrow pointing upwards from its bottom edge.</p>
bubble	<p>The signwriting for 'bubble' consists of a circle on the left, a square on the right, and a diamond on the right. Arrows indicate the movement of the hands: one arrow points from the circle to the square, and another points from the square to the diamond.</p>
bucket	<p>The signwriting for 'bucket' consists of a square on the left, a diamond on the right, and a diamond on the right. Arrows indicate the movement of the hands: one arrow points from the square to the diamond, and another points from the diamond to the diamond.</p>

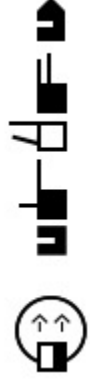





ASL Bible Dictionary

Spoken Word	SignWriting
bug eyes	
bugle	
bugle	
bugs	
build	



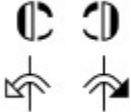
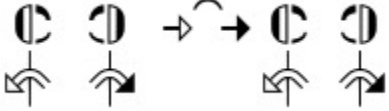



ASL Bible Dictionary

Spoken Word	SignWriting
build	<p>The sign for 'build' is composed of two mirrored hand configurations. The top configuration shows a right hand with an arrow pointing right, a left hand with an arrow pointing left, and a central upward-pointing arrow. The bottom configuration is a mirror image of the top, with the right hand arrow pointing left and the left hand arrow pointing right.</p>
builder	<p>The sign for 'builder' consists of three parts. The top part is a mirrored hand configuration with a curved arrow on the left hand pointing towards the center. The middle part is another mirrored hand configuration. The bottom part consists of two vertical hand configurations, each with an upward-pointing arrow on the left hand and a downward-pointing arrow on the right hand.</p>
builders	<p>The sign for 'builders' is similar to 'builder' but includes an additional downward-pointing arrow on the right hand of each of the two vertical hand configurations at the bottom.</p>
bull	<p>The sign for 'bull' is a circular hand configuration with a square on the left hand and a small circle on the right hand.</p>
bulls	<p>The sign for 'bulls' is identical to 'bull' but includes two asterisks (**) above the square on the left hand.</p>
bulls	<p>The sign for 'bulls' is a vertical sequence of four hand configurations. The top configuration is a square on the left hand and a small circle on the right hand. The second configuration is a square on the left hand and a horizontal line on the right hand. The third configuration is a square on the left hand and a horizontal line on the right hand. The bottom configuration is a square on the left hand and a horizontal line on the right hand.</p>







ASL Bible Dictionary

Spoken Word	SignWriting
bulrushes	
bum	
bunch	
bunches	
bundle	
Bunni	
Burbank	

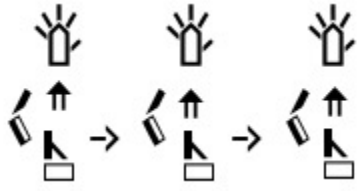



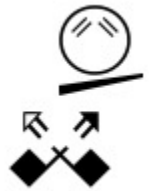

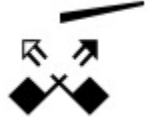
ASL Bible Dictionary

Spoken Word	SignWriting
burden	
burdensome	
burlap	
burn	
burn	
burrow	
burst	



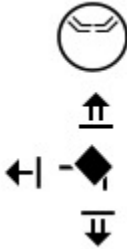





ASL Bible Dictionary

Spoken Word	SignWriting
bush	
bushes	
busy	
busy	
but	
but	
but	
but	
but	

ASL Bible Dictionary

Spoken Word	SignWriting
but	
but	
but	
butt	
butter	
buy	
buy	
buy	



ASL Bible Dictionary

Spoken Word	SignWriting
buy	
buy	
Buz	
by	
by	
bye	
bye	
bye	

ASL Bible Dictionary

Spoken Word	SignWriting
bytdwd	
c	
C	
cabinet	
Caesar	
Caesarea	

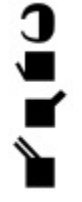
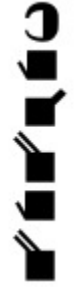



ASL Bible Dictionary

Spoken Word	SignWriting
Caiaphas	
Cain	
Cainan	
cake	
Calah	





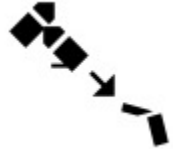



ASL Bible Dictionary

Spoken Word	SignWriting
calamity	<p>The SignWriting for 'calamity' consists of two parts. The first part shows a hand with fingers spread, moving from a vertical position to a horizontal position, indicated by a curved arrow. This is followed by a hand with fingers spread, moving from a horizontal position to a vertical position, also indicated by a curved arrow. The second part shows a hand with fingers spread, moving from a vertical position to a horizontal position, indicated by a curved arrow. This is followed by a hand with fingers spread, moving from a horizontal position to a vertical position, also indicated by a curved arrow.</p>

ASL Bible Dictionary

Spoken Word	SignWriting
Calder	 <p>The signwriting for 'Calder' consists of a vertical sequence of symbols: a circle with a dot inside, a square with a dot inside, a horizontal line, a square with a dot inside, a circle with a dot inside, a square with a dot inside, and a square with a dot inside.</p>
calf	 <p>The signwriting for 'calf' consists of a vertical sequence of symbols: a circle with a dot inside, a square with a dot inside, a horizontal line, a square with a dot inside, and a hand with fingers spread.</p>
California	 <p>The signwriting for 'California' starts with a circle, followed by a hand with fingers spread, then a square with a dot inside, and finally a square with a dot inside.</p>
call	 <p>The signwriting for 'call' consists of a sequence of symbols: a square with a dot inside, a square with a dot inside, a hand with fingers spread, and a square with a dot inside.</p>
call	 <p>The signwriting for 'call' consists of a circle with a dot inside and a hand with fingers spread.</p>
call	 <p>The signwriting for 'call' starts with a hand with fingers spread, followed by a circle with a dot inside, a horizontal line, and finally a sequence of symbols: a square with a dot inside, a square with a dot inside, a hand with fingers spread, and a square with a dot inside.</p>







ASL Bible Dictionary

Spoken Word	SignWriting
call	
call	
call	
call	
call	
call	
call	
call	

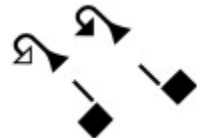

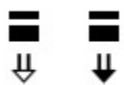
ASL Bible Dictionary

Spoken Word	SignWriting
call	<p>The sign for 'call' is composed of three distinct signs: a diamond shape with an arrow pointing down and to the right, a diamond shape with an arrow pointing down and to the left, and a solid black square.</p>
called	<p>The sign for 'called' is composed of three distinct signs: a hand with fingers spread pointing to the right, a diamond shape with an arrow pointing down, and a hand with fingers spread pointing to the right.</p>
Calneh	<p>The sign for 'Calneh' is composed of five distinct signs: a diamond shape with an arrow pointing down and to the right, a diamond shape with an arrow pointing down and to the left, a hand with fingers spread pointing to the right, a hand with fingers spread pointing to the left, and a diamond shape with an arrow pointing down.</p>
Calneh	<p>The sign for 'Calneh' is composed of five distinct signs: a diamond shape with an arrow pointing down and to the right, a diamond shape with an arrow pointing down and to the left, a hand with fingers spread pointing to the right, a hand with fingers spread pointing to the left, and a diamond shape with an arrow pointing down.</p>
came	<p>The sign for 'came' is composed of two distinct signs: a diamond shape with an arrow pointing down and to the right, and a diamond shape with an arrow pointing down and to the left.</p>
came	<p>The sign for 'came' is composed of two distinct signs: a diamond shape with an arrow pointing down and to the left, and a diamond shape with an arrow pointing down and to the right.</p>
came	<p>The sign for 'came' is composed of two distinct signs: a diamond shape with an arrow pointing down and to the right, and a solid black square.</p>





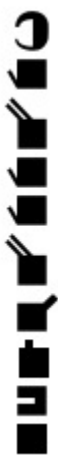

ASL Bible Dictionary

Spoken Word	SignWriting
came	
came	
camel	
can	
can	
can't	
Cana	



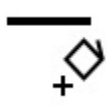



ASL Bible Dictionary

Spoken Word	SignWriting
Canaan	
Canaanites	
Canaanites	

ASL Bible Dictionary

Spoken Word	SignWriting
Canaanites	
Canaanitish	
Canada	
cancel	
cancer	
cancer	



ASL Bible Dictionary

Spoken Word	SignWriting
cancer	
candle	
candle	
candle	
candle-flicker	
candle-out	





ASL Bible Dictionary

Spoken Word	SignWriting
candle-out	<p>The SignWriting for 'candle-out' consists of three parts: a circle with horizontal lines radiating from its top and bottom, representing a candle flame; a small trapezoidal shape representing the candle body; and a small horizontal line representing the wick.</p>
candles-blowout	<p>The SignWriting for 'candles-blowout' is a sequence of six elements: a candle flame, a hand with fingers spread, another candle flame, another hand with fingers spread, a third candle flame, and a final hand with fingers spread.</p>
cant	<p>The SignWriting for 'cant' consists of three parts: a circle with a hand on top moving in a clockwise direction; two diamond shapes positioned below the circle; and a downward-pointing arrow below the diamonds.</p>
cant	<p>The SignWriting for 'cant' consists of two parts: two diamond shapes positioned above a downward-pointing arrow.</p>

ASL Bible Dictionary

Spoken Word	SignWriting
<p>Canterbury</p>	
<p>Capernaum</p>	
<p>Capernaum</p>	

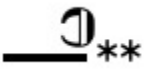





ASL Bible Dictionary

Spoken Word	SignWriting
Capthorim	
capital	
capital	
capital	
Cappadocia	

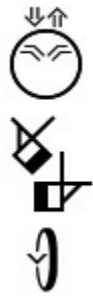
ASL Bible Dictionary

Spoken Word	SignWriting
cardiovascular	<p>The signwriting for 'cardiovascular' is a vertical sequence of 15 symbols. From top to bottom: a square with an 'x' on the left, a square with a vertical line on the left, a square with a horizontal line on the top, a circle with a horizontal line on the top, a square with a horizontal line on the top, a square with a horizontal line on the top, a square with a horizontal line on the top, a square with a horizontal line on the top, a square with a horizontal line on the top, a square with a horizontal line on the top, a square with a horizontal line on the top, a square with a horizontal line on the top, a square with a horizontal line on the top, a square with a horizontal line on the top, and a square with a horizontal line on the top.</p>
care	<p>The signwriting for 'care' consists of three symbols. From top to bottom: a square with an 'x' on the left, a square with a horizontal line on the top, and a circle with a horizontal line on the top.</p>
care	<p>The signwriting for 'care' consists of four symbols. From top to bottom: a circle with a horizontal line on the top and an upward arrow, a square with an 'x' on the left, a square with a horizontal line on the top, and a circle with a horizontal line on the top.</p>
care	<p>The signwriting for 'care' consists of three symbols. From top to bottom: a square with an 'x' on the left, a square with a horizontal line on the top, and a circle with a horizontal line on the top.</p>

ASL Bible Dictionary

Spoken Word	SignWriting
careful	
careful	
careless	
cares	
caretaker	
caretakers	





ASL Bible Dictionary

Spoken Word	SignWriting
cargo	
Carl	
Carmel	
Carmi	
Carnegie	

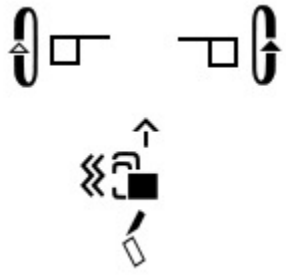
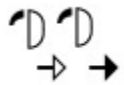

ASL Bible Dictionary

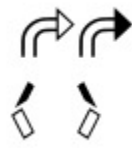
Spoken Word	SignWriting
<p>carnelian</p>	
<p>Carol</p>	
<p>Carolina</p>	
<p>carotid</p>	

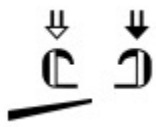

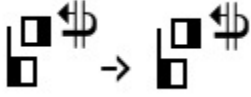
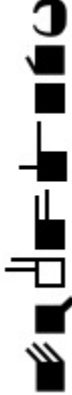
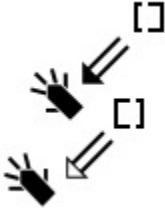

ASL Bible Dictionary

Spoken Word	SignWriting
carriage	 <p>The signwriting for 'carriage' consists of a vertical sequence of symbols: a 'C' shape, a 'C' with a horizontal line, a 'C' with a vertical line, a 'C' with a horizontal line, a 'C' with a vertical line, a 'C' with a horizontal line, a 'C' with a vertical line, and a 'C' with a horizontal line.</p>
carriage	 <p>The signwriting for 'carriage' consists of two parts. The top part shows two 'C' shapes with horizontal lines, one on the left and one on the right. The bottom part shows a 'C' shape with a horizontal line, a 'C' shape with a vertical line, and a 'C' shape with a horizontal line, all with arrows indicating movement.</p>
carry	 <p>The signwriting for 'carry' consists of two 'C' shapes with horizontal lines, one on the left and one on the right, with arrows pointing to the right below them.</p>
carry	 <p>The signwriting for 'carry' consists of a horizontal line, a vertical line, and a 'C' shape with a horizontal line, all connected by lines.</p>
carry	 <p>The signwriting for 'carry' consists of two 'C' shapes with horizontal lines, one on the left and one on the right, with arrows pointing to the right above them.</p>
carry	 <p>The signwriting for 'carry' consists of a horizontal line, a vertical line, and a 'C' shape with a horizontal line, all connected by lines.</p>
carry-cross	 <p>The signwriting for 'carry-cross' consists of two 'C' shapes with horizontal lines, one on the left and one on the right, with arrows pointing to the right above them, and a horizontal line below them.</p>



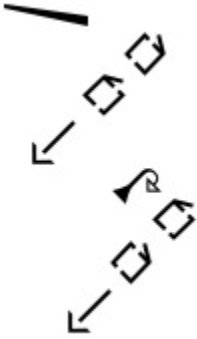

ASL Bible Dictionary

Spoken Word	SignWriting
Carshena	
carve	
case	
cases	
Casluhim	
cast-out	

ASL Bible Dictionary

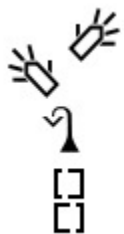
Spoken Word	SignWriting
catch-fish	
catch-fish	
Catherine	
Cauda	
cause	









ASL Bible Dictionary

Spoken Word	SignWriting
cause	 <p>The signwriting for 'cause' (verb) consists of two hands starting in an 'L' handshape. The right hand moves down and then back up, while the left hand remains relatively stationary. This is followed by two square boxes, one above the other, representing the final part of the sign.</p>
cause	 <p>This signwriting is identical to the one above, showing the hand movements and the two square boxes.</p>
cave	 <p>The signwriting for 'cave' (noun) is a vertical sequence of symbols: a circle, a square, a triangle, and a horizontal line.</p>
cave	 <p>This signwriting for 'cave' (noun) includes a hash symbol (#) at the top, followed by a square, a triangle, a horizontal line, and a curved arrow pointing downwards. Below these is a square with an upward-pointing arrow.</p>
caves	 <p>The signwriting for 'caves' (noun) is a vertical sequence of symbols: a circle, a square, a triangle, and a horizontal line.</p>



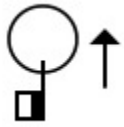

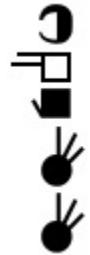
ASL Bible Dictionary

Spoken Word	SignWriting
cedar	<p>The signwriting for 'cedar' consists of a vertical sequence of symbols: a 'C' with a dot, a 'N' with a dot, a horizontal line, a 'D' with a dot, a 'R' with a dot, and a 'G' with a dot.</p>
celebration	<p>The signwriting for 'celebration' consists of two columns of symbols. The left column has a 'D' with a dot and a 'G' with a dot. The right column has a 'D' with a dot and a 'G' with a dot.</p>
cell	<p>The signwriting for 'cell' consists of a vertical sequence of symbols: a 'C' with a dot, a 'N' with a dot, a horizontal line, a 'D' with a dot, and a 'G' with a dot.</p>
cells	<p>The signwriting for 'cells' consists of a vertical sequence of symbols: a 'C' with a dot, a 'N' with a dot, a horizontal line, a 'D' with a dot, a 'G' with a dot, and a 'G' with a dot.</p>
cemetery	<p>The signwriting for 'cemetery' consists of two columns of symbols. The left column has a 'D' with a dot and a 'G' with a dot. The right column has a 'D' with a dot, a 'G' with a dot, and a 'G' with a dot.</p>
Cenchrea	<p>The signwriting for 'Cenchrea' consists of a vertical sequence of symbols: a 'C' with a dot, a 'N' with a dot, a 'C' with a dot, a 'D' with a dot, a 'G' with a dot, and a 'G' with a dot.</p>

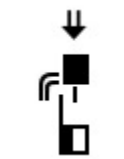
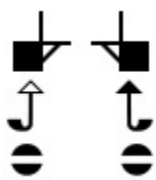
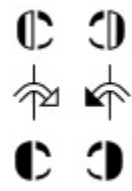

ASL Bible Dictionary

Spoken Word	SignWriting
century	
CEO	
Cephas	
cereal	
certain	
certainly	
certify	
chaff	
chain	

ASL Bible Dictionary

Spoken Word	SignWriting
challenge	
champ	
champion	
chance	
chance	
change	
change	

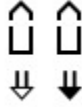
ASL Bible Dictionary

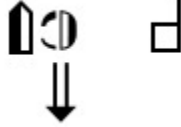
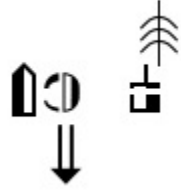
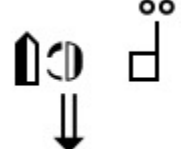
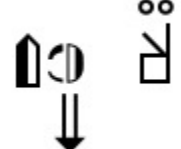
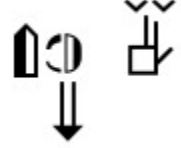
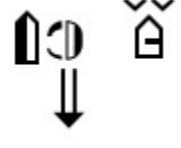
Spoken Word	SignWriting
change sign	
chapter	
Chapter 1	
Chapter 10	
Chapter 11	
Chapter 12	
Chapter 13	
Chapter 14	



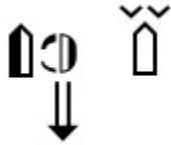
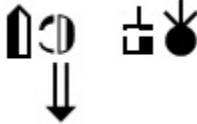
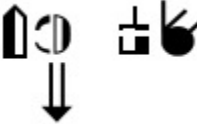
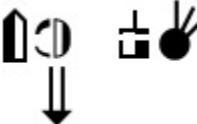
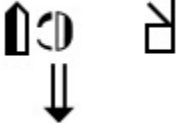
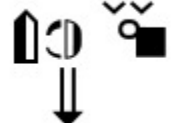
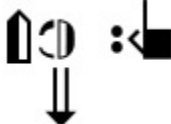
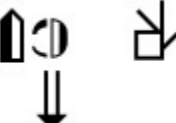
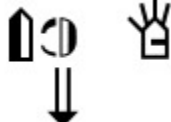

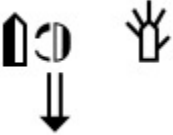
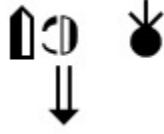
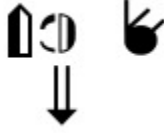
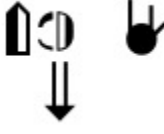
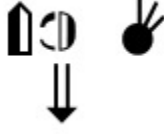
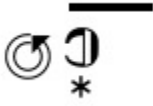
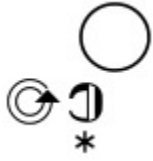

ASL Bible Dictionary

Spoken Word	SignWriting
Chapter 15	
Chapter 16	
Chapter 17	
Chapter 19	
Chapter 2	
Chapter 20	
Chapter 21	
Chapter 3	
Chapter 4	

ASL Bible Dictionary

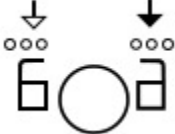
Spoken Word	SignWriting
Chapter 5	
Chapter 6	
Chapter 7	
Chapter 8	
Chapter 9	
character	
character	







ASL Bible Dictionary

Spoken Word	SignWriting
charcoal	
charged	
Chargers	
charges	
charges	
charges	
charges	

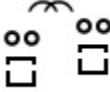
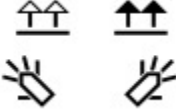



ASL Bible Dictionary

Spoken Word	SignWriting
chariot	<p>The signwriting for 'chariot' consists of two hands positioned above a central circle. Each hand has a downward-pointing arrow above it. Below the circle, there is an upward-pointing arrow, and two hands positioned on either side, each with a downward-pointing arrow above it.</p>
Charlotte	<p>The signwriting for 'Charlotte' is a vertical sequence of seven distinct hand configurations, each with a downward-pointing arrow above it, representing the letters C, H, A, R, L, O, TTE.</p>
chase	<p>The signwriting for 'chase' shows three hand configurations in a diagonal line from top-left to bottom-right, each with a downward-pointing arrow above it.</p>
chase	<p>The signwriting for 'chase' shows three hand configurations in a diagonal line from bottom-left to top-right, each with a downward-pointing arrow above it.</p>
chasm	<p>The signwriting for 'chasm' features a circle at the top containing two downward-pointing arrows. Below it are two vertical double-headed arrows, one on the left and one on the right.</p>
chat	<p>The signwriting for 'chat' consists of two vertical columns of three hand configurations each, each with a downward-pointing arrow above it.</p>



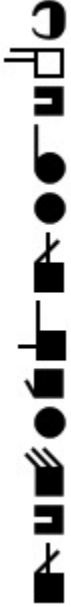

ASL Bible Dictionary

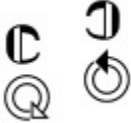
Spoken Word	SignWriting
chat	
chat	
cheap	
cheat	
cheat	
cheat	
cheat	

ASL Bible Dictionary

Spoken Word	SignWriting
Chedorlaomer	
cheerful	
cheese	
cheetah	
chemistry	





ASL Bible Dictionary

Spoken Word	SignWriting
Cheran	
cherubim	
Chesapeake	
Chesed	





ASL Bible Dictionary

Spoken Word	SignWriting
chesnut	<p>The SignWriting for 'chesnut' consists of a vertical sequence of symbols: a 'C' shape, a 'P' shape, a 'N' shape, a 'T' shape, a 'C' shape, a 'H' shape, and a 'S' shape.</p>
chest	<p>The SignWriting for 'chest' consists of a horizontal line above a 'C' shape, followed by an '@' symbol and an arrow pointing to the right.</p>
chest	<p>The SignWriting for 'chest' consists of a central 'C' shape with two 'H' shapes on either side. Arrows point from the 'C' to the 'H's, and from the 'H's to the 'C'. Below each 'H' is a double-headed vertical arrow.</p>
Chezib	<p>The SignWriting for 'Chezib' consists of a vertical sequence of symbols: a 'C' shape, a 'P' shape, a 'Z' shape, a 'B' shape, a 'C' shape, and a 'H' shape.</p>
Chicago	<p>The SignWriting for 'Chicago' consists of a 'C' shape followed by an arrow pointing down and to the right.</p>
chicken	<p>The SignWriting for 'chicken' consists of two parts: a 'C' shape with a 'H' shape inside it, and a 'C' shape with a 'H' shape and a 'K' shape inside it.</p>
chief	<p>The SignWriting for 'chief' consists of a 'C' shape with a 'H' shape inside it, followed by a 'C' shape with a 'H' shape inside it.</p>



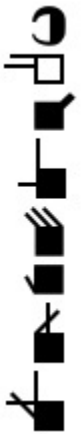

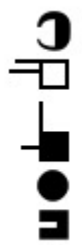

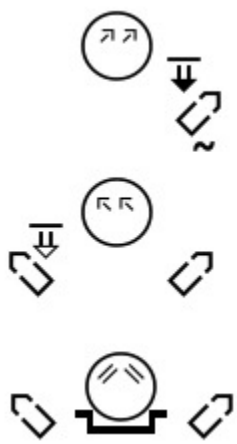
ASL Bible Dictionary

Spoken Word	SignWriting
chief	
child	
children	
children	

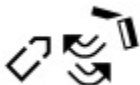

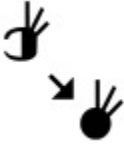

ASL Bible Dictionary

Spoken Word	SignWriting
Chilmark	 <p>The SignWriting for 'Chilmark' consists of a vertical sequence of seven symbols: a circle with a horizontal line, a square with a vertical line, a square with a horizontal line, a square with a diagonal line, a square with a horizontal line, a square with a vertical line, and a square with a horizontal line.</p>
China	 <p>The SignWriting for 'China' consists of a diamond shape with a small asterisk to its left, and a square with a horizontal line and a downward-pointing arrow to its right.</p>
Chloe	 <p>The SignWriting for 'Chloe' consists of a vertical sequence of four symbols: a circle with a horizontal line, a square with a vertical line, a square with a horizontal line, and a square with a horizontal line.</p>
choice	 <p>The SignWriting for 'choice' consists of a square with a horizontal line and a downward-pointing arrow, and a square with a horizontal line and a downward-pointing arrow.</p>
choice	 <p>The SignWriting for 'choice' consists of three circular symbols arranged vertically. The top circle contains the number 22. The middle circle contains the number 22. The bottom circle contains the number 22. Each circle is surrounded by four small square symbols, one on each side.</p>

ASL Bible Dictionary

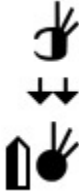
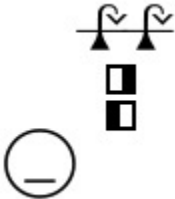
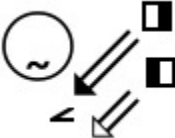
Spoken Word	SignWriting
choir	
choke	
choke-plant	
choose	
choose	
choose	
choose	

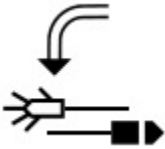

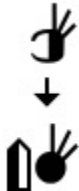

ASL Bible Dictionary

Spoken Word	SignWriting
chooses	
chop	
chop	
chop	
chop-down	
chop-ready	
chosen	





ASL Bible Dictionary

Spoken Word	SignWriting
chosen	<p>The signwriting for 'chosen' consists of three vertical elements: a hand with fingers spread, two downward-pointing arrows, and a hand with fingers spread and a solid black circle below it.</p>
chris-cross	<p>The signwriting for 'chris-cross' is a cross shape formed by two intersecting lines, with a solid black diamond at the end of each arm.</p>
Christ	<p>The signwriting for 'Christ' features a circle with a horizontal line through its center, followed by an asterisk, a downward-pointing arrow, and another asterisk.</p>
Christ	<p>The signwriting for 'Christ' includes a circle with a horizontal line through its center, an asterisk, a downward-pointing arrow, another asterisk, and a separate diamond shape to the right.</p>
Christian	<p>The signwriting for 'Christian' is a vertical sequence of symbols: a circle with a horizontal line through its center, a square, a hand with fingers spread, a solid black square, a hand with fingers spread, a solid black square, a hand with fingers spread, a solid black square, a hand with fingers spread, a solid black square, and a hand with fingers spread.</p>
Christian	<p>The signwriting for 'Christian' consists of a circle with a horizontal line through its center, an asterisk, a downward-pointing arrow, another asterisk, and two separate diamond shapes at the bottom, each with a downward-pointing arrow below it.</p>





ASL Bible Dictionary

Spoken Word	SignWriting
chrysoprase	
church	
churches	
churn	
Chuza	

ASL Bible Dictionary

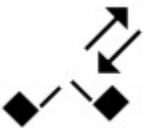
Spoken Word	SignWriting
Cilicia	
Cincinnati	
Cindy	
cinnamon	
circle	

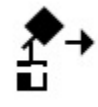
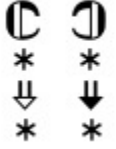

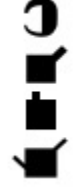
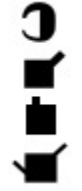
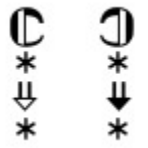

ASL Bible Dictionary

Spoken Word	SignWriting
circuit	
circumcise	
circumcision	
citizen	
city	
city	
City	
civil	



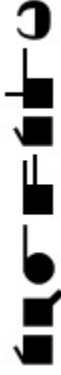

ASL Bible Dictionary

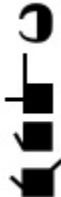
Spoken Word	SignWriting
civil	<p>The sign for 'civil' is written vertically. It starts with a circle containing a horizontal line, followed by a series of horizontal bars of varying lengths, and ends with a vertical line.</p>
clap	<p>The sign for 'clap' is written vertically. It begins with a circle containing a horizontal line, followed by two sets of three horizontal bars, each set with a vertical line extending downwards from its center.</p>
class	<p>The sign for 'class' is written vertically. It consists of two identical units, each featuring a circle with a horizontal line, a vertical line, and a horizontal bar.</p>
classical	<p>The sign for 'classical' is written vertically. It starts with a circle containing a horizontal line, followed by a series of horizontal bars, and ends with a vertical line.</p>
classifier	<p>The sign for 'classifier' is written vertically. It features a vertical line with a horizontal bar extending to the right, and a horizontal line with a vertical bar extending downwards.</p>
classifier	<p>The sign for 'classifier' is written vertically. It features a vertical line with a horizontal bar extending to the right, and a horizontal line with a vertical bar extending downwards.</p>
classifier-millstone	<p>The sign for 'classifier-millstone' is written vertically. It consists of two identical units, each featuring a circle with a horizontal line, a vertical line, and a horizontal bar.</p>





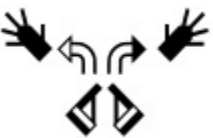
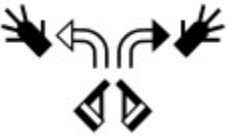

ASL Bible Dictionary

Spoken Word	SignWriting
Claudia	
Claudius	
claws	
claws	
clay	

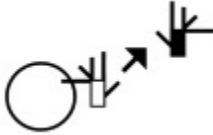
ASL Bible Dictionary

Spoken Word	SignWriting
clean	
clean	
clean	
clear	
clear	
Clement	
Cleopas	

ASL Bible Dictionary

Spoken Word	SignWriting
clever	
climate	
climb	
climb-tree	
climb-tree	
cling	

ASL Bible Dictionary

Spoken Word	SignWriting
clinical	
Clinton	
Clopas	
close	
close-eyes	
close-gate	





ASL Bible Dictionary

Spoken Word	SignWriting
close-Him	<p>The signwriting for 'close-Him' consists of a circle containing two small arrows pointing towards each other, followed by a hand with fingers spread and an arrow pointing upwards and to the right.</p>
close-to	<p>The signwriting for 'close-to' shows two hands, one above the other, with arrows indicating movement towards each other.</p>
close-to	<p>The signwriting for 'close-to' shows a hand with fingers spread and an arrow pointing upwards, followed by another hand with fingers spread and an arrow pointing downwards.</p>
close-to	<p>The signwriting for 'close-to' shows two hands, one above the other, with arrows indicating movement towards each other.</p>
clothe	<p>The signwriting for 'clothe' shows two hands, one above the other, with arrows indicating movement towards each other, and a small circle with a dot above each hand.</p>
clothes	<p>The signwriting for 'clothes' shows two hands, one above the other, with arrows indicating movement towards each other, and a small asterisk above each hand.</p>
cloud	<p>The signwriting for 'cloud' consists of a circle containing two small arrows pointing towards each other, followed by a hand with fingers spread and an arrow pointing upwards and to the right, and another hand with fingers spread and an arrow pointing downwards and to the right.</p>
club	<p>The signwriting for 'club' shows a vertical sequence of symbols: a circle with a dot, a horizontal line, a square, and an arrow pointing downwards.</p>



ASL Bible Dictionary

Spoken Word	SignWriting
club	<p>The SignWriting for 'club' consists of three parts: a handshape with a pointing finger and a thumb, a double arrow pointing up, and a circle with a horizontal line through it.</p>
club	<p>The SignWriting for 'club' consists of three parts: a circle with a horizontal line through it, a double arrow pointing up, and a circle with a horizontal line through it.</p>
clubs	<p>The SignWriting for 'clubs' consists of three parts: a handshape with a pointing finger and a thumb, a double arrow pointing up, and a circle with a horizontal line through it.</p>
clubs	<p>The SignWriting for 'clubs' consists of three parts: a circle with a horizontal line through it, a horizontal line, and a circle with a horizontal line through it.</p>
clusters	<p>The SignWriting for 'clusters' consists of three parts: a circle with a horizontal line through it, a double arrow pointing up, and a circle with a horizontal line through it.</p>

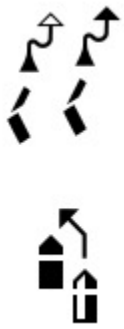

ASL Bible Dictionary

Spoken Word	SignWriting
Cnidus	
co-	
co-worker	
co-write	
coals	

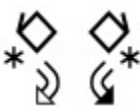
ASL Bible Dictionary

Spoken Word	SignWriting
coast	 <p>The SignWriting for 'coast' in the first row consists of two parts. The top part shows two hands with fingers spread, each moving in a wavy, upward-spiraling path. The bottom part shows two hands, one with a solid black square on the palm side and the other with a white square on the palm side, both moving in a similar wavy path.</p>
coast	 <p>The SignWriting for 'coast' in the second row is identical to the first row, showing two wavy hand movements and two hands with solid and white palm-side squares.</p>
coat	 <p>The SignWriting for 'coat' in the third row shows two hands with fingers spread, each moving in a wavy path. The hands are marked with solid black squares on the palm side and white squares on the back side, with asterisks indicating the specific hand configurations.</p>

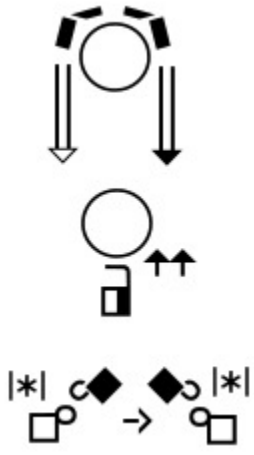
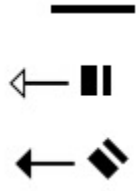
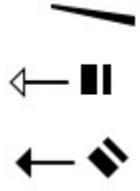



ASL Bible Dictionary

Spoken Word	SignWriting
coat of mail	
coat-road	
coat-road	
cobra	
cobra	

ASL Bible Dictionary

Spoken Word	SignWriting
cobras	<p>The SignWriting for 'cobras' consists of a vertical sequence of signs: a circle, a vertical line, a vertical line with a downward arrow, a vertical line with a downward arrow, a vertical line with a downward arrow, and a vertical line with a downward arrow.</p>
cochlear	<p>The SignWriting for 'cochlear' consists of a circle followed by a hand sign with the index finger pointing up and the thumb pointing right.</p>
coded	<p>The SignWriting for 'coded' consists of a vertical sequence of signs: a circle, a vertical line, a vertical line with a downward arrow, a vertical line with a downward arrow, and a vertical line with a downward arrow.</p>
codified	<p>The SignWriting for 'codified' consists of a vertical sequence of signs: a circle, a vertical line, a vertical line with a downward arrow, a vertical line with a downward arrow, a vertical line with a downward arrow, a vertical line with a downward arrow, a vertical line with a downward arrow, and a vertical line with a downward arrow.</p>
coffee	<p>The SignWriting for 'coffee' consists of a hand sign with the index finger pointing up and the thumb pointing right, followed by a vertical line with a downward arrow.</p>



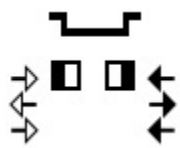

ASL Bible Dictionary

Spoken Word	SignWriting
Cogswell	
coin	
coins	
Col-	
cold	
cold	

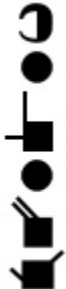

ASL Bible Dictionary

Spoken Word	SignWriting
cold	<p>The sign for 'cold' is composed of three parts: a smiley face with closed eyes at the top, and two sets of arrows below it. Each set consists of a square on the left and a square on the right, with arrows pointing towards each other and then away from each other, representing the 'C' and 'D' handshapes.</p>
collapse	<p>The sign for 'collapse' is composed of two parts: the top part shows two hands with fingers spread, palms facing each other, with a downward arrow between them; the bottom part shows two hands with fingers spread, palms facing away from each other.</p>
collector	<p>The sign for 'collector' is composed of two parts: the top part shows a hand with fingers spread, palm facing left, and a hand with fingers spread, palm facing right, with arrows indicating a circular motion; the bottom part shows two hands with fingers spread, palms facing away from each other, with downward arrows below them.</p>
collectors	<p>The sign for 'collectors' is composed of two parts: the top part shows a hand with fingers spread, palm facing left, and a hand with fingers spread, palm facing right, with arrows indicating a circular motion; the bottom part shows two hands with fingers spread, palms facing away from each other, with downward arrows and a rightward arrow below each hand.</p>
Colonel	<p>The sign for 'Colonel' is a vertical sequence of seven distinct handshapes: a 'C' handshape, a 'O' handshape, a 'N' handshape, a 'L' handshape, a 'N' handshape, a 'N' handshape, and a 'L' handshape.</p>

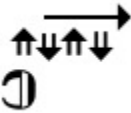

ASL Bible Dictionary

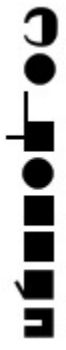
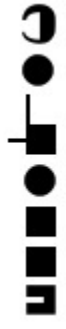
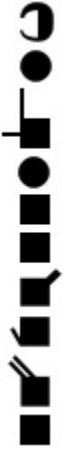
Spoken Word	SignWriting
Colonnade	
colony	
colony	
color	
Colorado	



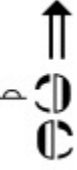
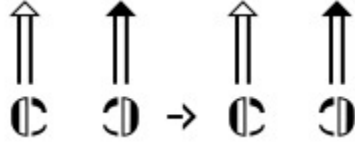
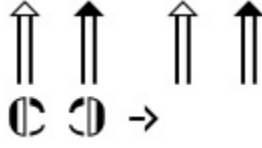

ASL Bible Dictionary

Spoken Word	SignWriting
Colossae	
Colosse	
Colossians	
colt	







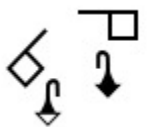
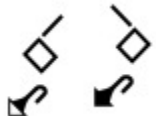
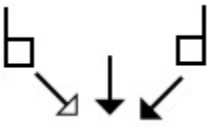
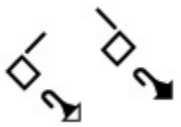

ASL Bible Dictionary

Spoken Word	SignWriting
Columbia	
column	
columns	
columnnade	
columnnade	

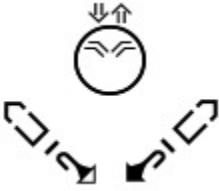

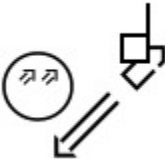

ASL Bible Dictionary

Spoken Word	SignWriting
com	
coma	
comb	
comb	
come	
come	
come	
come	
come	

ASL Bible Dictionary

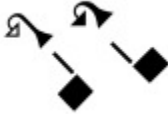
Spoken Word	SignWriting
come	
come	
come	
come	
come	
come	
come	
come	

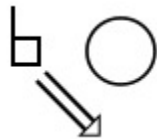
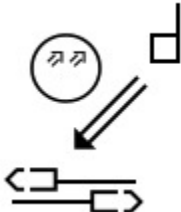





ASL Bible Dictionary

Spoken Word	SignWriting
come	
Come Thou Fount 1	
Come Thou Fount 2	
Come Thou Fount 3	
Come Thou Fount 4	
Come Thou Fount 5	
Come Thou Fount 6	
Come Thou Fount 7	
Come Thou Fount 8	
come-and-go	
come-down	
come-down	
come-to-earth	

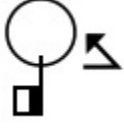



ASL Bible Dictionary

Spoken Word	SignWriting
come-to-earth	<p>The signwriting for 'come-to-earth' consists of a circle containing two arrows pointing towards each other, a small square, a diagonal arrow pointing down and to the right, and a horizontal line with arrows at both ends.</p>
come-upon	<p>The signwriting for 'come-upon' includes two hand symbols with wavy lines above them and arrows pointing down, a small square with an arrow pointing up and to the right, another small square with an arrow pointing up and to the left, and a large circle.</p>
comes	<p>The signwriting for 'comes' features a circle, a hand symbol with an arrow pointing down, and a hand symbol with an arrow pointing up and to the right.</p>
ComeThouFount01 - words	
ComeThouFount02 - words	
ComeThouFount03 - words	
ComeThouFount04 - words	
ComeThouFount05 - words	
ComeThouFount06 - words	
ComeThouFount07 - words	
ComeThouFount08 - words	
comfort	<p>The signwriting for 'comfort' shows two hand symbols with arrows pointing towards each other, one above the other.</p>



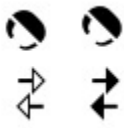

ASL Bible Dictionary

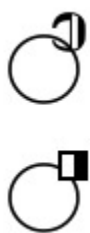
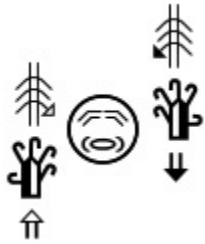
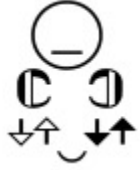
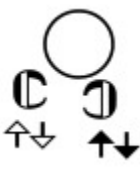
Spoken Word	SignWriting
Comforter	
comma	=
command	
command	
command	
command	
commands	
commend	



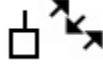

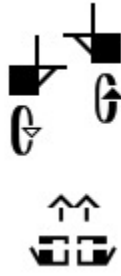

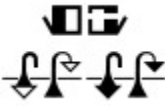
ASL Bible Dictionary

Spoken Word	SignWriting
commit	
committee	
committee	
common	
common-sense	
commotion	
communicate	
communicate	

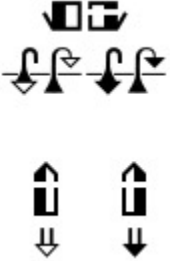



ASL Bible Dictionary

Spoken Word	SignWriting
community	
commute	
companion	
companions	
company	
compare	
compete	



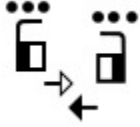



ASL Bible Dictionary

Spoken Word	SignWriting
competitor	
complain	
complainer	
complainers	
complaint	
complete	

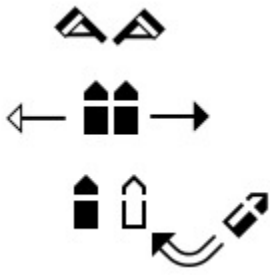

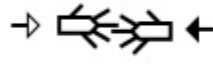

ASL Bible Dictionary

Spoken Word	SignWriting
completely	
complex	
complex	
comprehend	
compromise	
Conan	



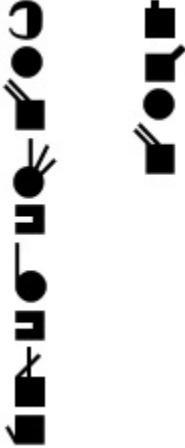
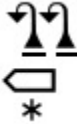

ASL Bible Dictionary

Spoken Word	SignWriting
concave	
concealed	
conceited	
conceited	
conceive	
concern	
Concord	



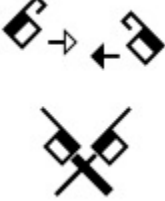
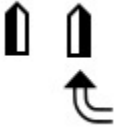
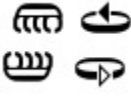

ASL Bible Dictionary

Spoken Word	SignWriting
condense	
Confederation	
confess	
confess	
confess	
confess	
confident	





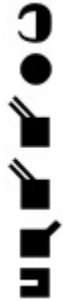

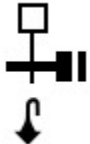
ASL Bible Dictionary

Spoken Word	SignWriting
confirm	
confirm	
conflict	
conflict	
confront	
confuse	
confuse	

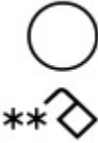

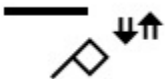
ASL Bible Dictionary

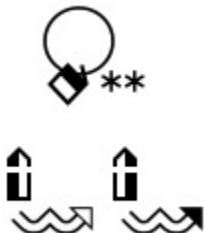
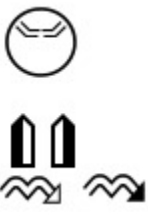
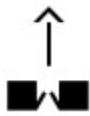
Spoken Word	SignWriting
connect	
Connecticut	
Connie	
Conover	
conquer	
conquer	



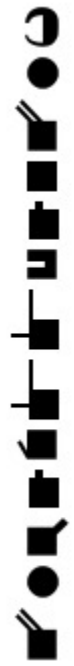
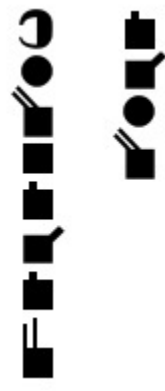

ASL Bible Dictionary

Spoken Word	SignWriting
conscience	
conscience	
conscience	
consider	
consider	
conspire	
conspired	
constant	
constant	



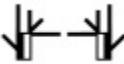

ASL Bible Dictionary

Spoken Word	SignWriting
Constellation	
Constellation	
Constitution	
construct	

ASL Bible Dictionary

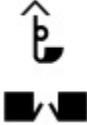
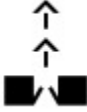
Spoken Word	SignWriting
construct	
consult	
consult	
contact	
content	



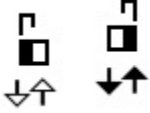

ASL Bible Dictionary

Spoken Word	SignWriting
continue	
continue	
continue	
continue	
continue	
contractor	
control	



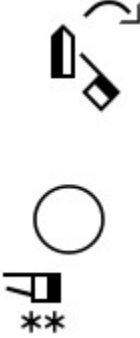

ASL Bible Dictionary

Spoken Word	SignWriting
control	<p>The sign for 'control' is represented by two square handshapes. The left hand has an upward arrow and a downward arrow, while the right hand has an upward arrow and a downward arrow.</p>
convert	<p>The sign for 'convert' is represented by two diamond handshapes, one above the other, followed by two U-shaped handshapes, one above the other.</p>
converts	<p>The sign for 'converts' is represented by two diamond handshapes, one above the other, followed by two U-shaped handshapes, one above the other, with a rightward arrow at the bottom of each.</p>
convict	<p>The sign for 'convict' is represented by a vertical sequence of handshapes: a diamond, a U-shape, a diamond, a U-shape, a diamond, a U-shape, and a diamond.</p>

ASL Bible Dictionary

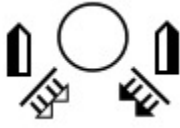
Spoken Word	SignWriting
convict	
convict	
convince	
convulsion	
cook	
cook	

ASL Bible Dictionary

Spoken Word	SignWriting
<p>cooking</p>	
<p>cool</p>	
<p>Cooper</p>	
<p>cooperate</p>	
<p>Copenhagen</p>	





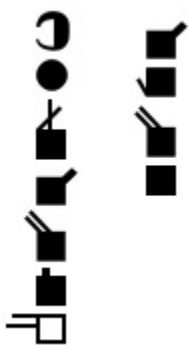
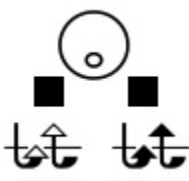
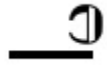
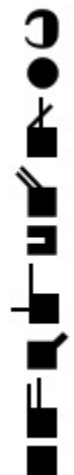

ASL Bible Dictionary

Spoken Word	SignWriting
copper	<p>The SignWriting for 'copper' consists of five vertical symbols: a crescent moon, a solid black circle, a diamond with a diagonal line from top-left to bottom-right, another diamond with a diagonal line from top-left to bottom-right, and a solid black square.</p>
copy	<p>The SignWriting for 'copy' consists of four vertical symbols: a hand with fingers spread, two vertical arrows pointing in opposite directions, a square with a diagonal line from top-left to bottom-right, and a solid black square.</p>
copy	<p>The SignWriting for 'copy' consists of four vertical symbols: a square with a diagonal line from top-left to bottom-right, two vertical arrows pointing in opposite directions, a hand with fingers spread, and a solid black square.</p>
Corinth	<p>The SignWriting for 'Corinth' consists of eight vertical symbols: a crescent moon, a solid black circle, a square with a diagonal line from top-left to bottom-right, a solid black square, a square with a diagonal line from top-left to bottom-right, a solid black square, a solid black square, and a square with a diagonal line from top-left to bottom-right.</p>

ASL Bible Dictionary

Spoken Word	SignWriting
Corinth	
Corinthians	
corn	
Cornelius	
Cornelius	







ASL Bible Dictionary

Spoken Word	SignWriting
corner	
cornerstone	
Corning	
corona	
corona	
coronation	

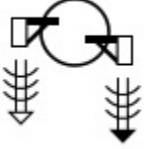



ASL Bible Dictionary

Spoken Word	SignWriting
corporate	<p>The SignWriting for 'corporate' consists of a vertical sequence of symbols: a C-shape, a solid black circle, a square with a diagonal line from top-left to bottom-right, and a diamond with a diagonal line from top-left to bottom-right.</p>
corpus	<p>The SignWriting for 'corpus' consists of a vertical sequence of symbols: a C-shape, a solid black circle, a square with a diagonal line from top-left to bottom-right, a diamond with a diagonal line from top-left to bottom-right, and a solid black square.</p>
correct	<p>The SignWriting for 'correct' consists of a vertical sequence of symbols: two asterisks, a square with a diagonal line from top-left to bottom-right, and a solid black square.</p>
correct	<p>The SignWriting for 'correct' consists of a vertical sequence of symbols: a square with a diagonal line from top-left to bottom-right, a solid black square, and a solid black square.</p>
correct	<p>The SignWriting for 'correct' consists of a vertical sequence of symbols: a square with a diagonal line from top-left to bottom-right, a diamond with a diagonal line from top-left to bottom-right, and a solid black square.</p>
correcting	<p>The SignWriting for 'correcting' consists of a vertical sequence of symbols: a square with a diagonal line from top-left to bottom-right, a diamond with a diagonal line from top-left to bottom-right, and a solid black square.</p>
corrupt	<p>The SignWriting for 'corrupt' consists of a vertical sequence of symbols: a solid black square, a diamond with a diagonal line from top-left to bottom-right, and a circle with a vertical line passing through its center.</p>







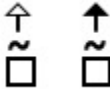
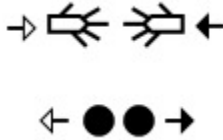
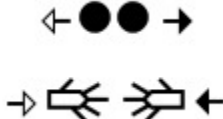

ASL Bible Dictionary

Spoken Word	SignWriting
Cosam	
cosmetic	
cost	
cotton	
couched	
couches	
council	







ASL Bible Dictionary

Spoken Word	SignWriting
Counselor	
count	
count	
count	
country	
courage	
courage	
courage	

ASL Bible Dictionary

Spoken Word	SignWriting
covenant	
cover	
cover	
cover	
cover	
cover	
cover	
cover	

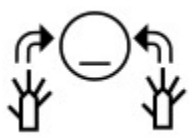





ASL Bible Dictionary

Spoken Word	SignWriting
cover-face	
cover-face	
cover-face	
covered	
covered-porches	
covering	
covers-earth	

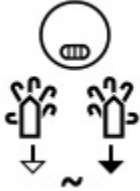

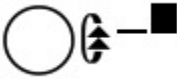

ASL Bible Dictionary

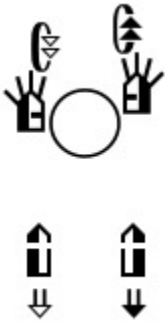
Spoken Word	SignWriting
Craftsmen	<p>The SignWriting for 'Craftsmen' is a vertical sequence of eight symbols. From top to bottom: a circle with a horizontal line through its center; a square with a diagonal line from the top-left to the bottom-right; a square with a diagonal line from the top-right to the bottom-left; a circle with a vertical line through its center; a square with a horizontal line through its center; a square with a vertical line through its center; a square with a horizontal line through its center; and a square with a vertical line through its center.</p>
cramp	<p>The SignWriting for 'cramp' consists of four symbols arranged vertically. From top to bottom: a circle with two curved lines above it; a hand symbol with fingers spread; a hand symbol with fingers spread; and a hand symbol with fingers spread.</p>
crash	<p>The SignWriting for 'crash' consists of three symbols arranged vertically. From top to bottom: a hand symbol with fingers spread; a downward-pointing arrow; and a square with a horizontal line through its center.</p>
crate	<p>The SignWriting for 'crate' consists of three symbols arranged horizontally. From left to right: a hand symbol with fingers spread; a square with a horizontal line through its center; and a hand symbol with fingers spread.</p>
crates	<p>The SignWriting for 'crates' is a vertical sequence of eight symbols, identical to the SignWriting for 'Craftsmen'. From top to bottom: a circle with a horizontal line through its center; a square with a diagonal line from the top-left to the bottom-right; a square with a diagonal line from the top-right to the bottom-left; a circle with a vertical line through its center; a square with a horizontal line through its center; a square with a vertical line through its center; a square with a horizontal line through its center; and a square with a vertical line through its center.</p>



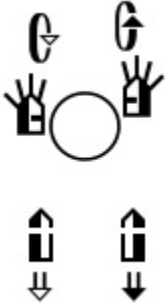

ASL Bible Dictionary

Spoken Word	SignWriting
crave	
crazy	
crazy	
create	
create	
Creation	
Creator	

ASL Bible Dictionary

Spoken Word	SignWriting
Creator	
credit	
creeping	
creole	
creoles	



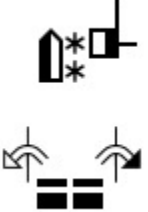



ASL Bible Dictionary

Spoken Word	SignWriting
Cretans	
Crete	
crew	
Cried	
crime	

ASL Bible Dictionary

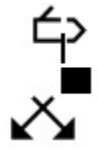
Spoken Word	SignWriting
<p>criminal</p>	<p>The SignWriting for 'criminal' consists of three parts: a top symbol with a house-like shape, a star, and a vertical line; a middle symbol with two curved arrows pointing outwards from a central horizontal bar; and a bottom symbol with two vertical bars, each with an upward arrow on top and a downward arrow on bottom.</p>
<p>criminals</p>	<p>The SignWriting for 'criminals' consists of three parts: a top symbol with a house-like shape, a star, and a vertical line; a middle symbol with two curved arrows pointing outwards from a central horizontal bar, flanked by two small squares; and a bottom symbol with two vertical bars, each with an upward arrow on top and a rightward arrow on bottom.</p>
<p>Crispus</p>	<p>The SignWriting for 'Crispus' is a vertical sequence of symbols: a crescent moon, a house-like shape with a vertical line, a square, a diamond with a diagonal line, and a horizontal bar.</p>
<p>critical</p>	<p>The SignWriting for 'critical' consists of two parts: a top symbol with a circle, a vertical line, and an upward arrow; and a bottom symbol with two eyes, each with a rightward arrow below it.</p>

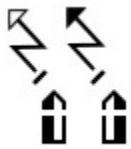
ASL Bible Dictionary

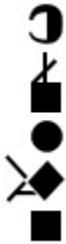
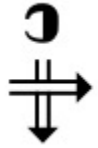
Spoken Word	SignWriting
criticism	
criticize	
criticize	
critics	
crooked	
crooked	
crops	
cross	



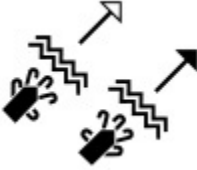

ASL Bible Dictionary

Spoken Word	SignWriting
cross-off	<p>The signwriting for 'cross-off' consists of three parts: a circle with a downward arrow above and an upward arrow below; a stylized 'C' shape with a vertical line through its center; and a downward-pointing arrow.</p>
crosses	<p>The signwriting for 'crosses' shows two stylized 'C' shapes with vertical lines through their centers. The left 'C' has a horizontal line extending to the left, and the right 'C' has a horizontal line extending to the right. Both have downward-pointing arrows below them.</p>
crosses	<p>The signwriting for 'crosses' shows two stylized 'C' shapes with vertical lines through their centers. The left 'C' has a horizontal line extending to the left, and the right 'C' has a horizontal line extending to the right. Both have downward-pointing arrows below them.</p>
crow	<p>The signwriting for 'crow' features a circle with a wavy line above it and an upward arrow above the circle. Below the circle is a solid black shape.</p>
crowd	<p>The signwriting for 'crowd' shows two hands with fingers spread, each with an arrow pointing upwards and to the right.</p>
crowd	<p>The signwriting for 'crowd' shows two hands with fingers spread, each with a zigzag line above it and an arrow pointing upwards and to the right.</p>
crowd	<p>The signwriting for 'crowd' shows two hands with fingers spread, each with an arrow pointing upwards and to the left.</p>



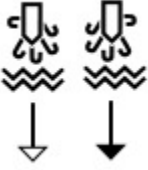
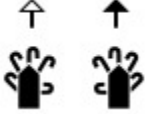

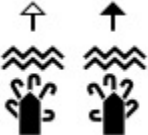
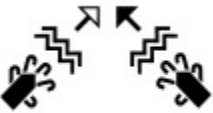

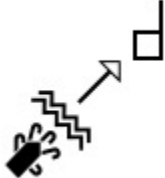
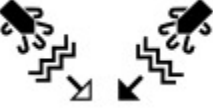
ASL Bible Dictionary

Spoken Word	SignWriting
crowd	

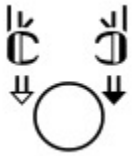
ASL Bible Dictionary

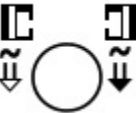
Spoken Word	SignWriting
crowd	
crowd	
crowd	
crowd	
crowd	
crowd	
crowd-meet	
crowds	

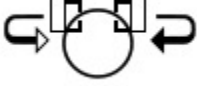
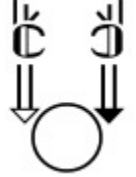
ASL Bible Dictionary

Spoken Word	SignWriting
crowds	
crown	
crown	
crown	
crown	
crown	
crowned	
crows	
crows	





ASL Bible Dictionary

Spoken Word	SignWriting
crucifixion	<p>The SignWriting for 'crucifixion' consists of a circle containing two small 'r' characters (representing the sign for 'cross'), followed by a sequence of hand shapes and arrows: a hand with fingers spread, a hand with fingers spread and a '#' symbol, a hand with fingers spread and a '#' symbol, a hand with fingers spread and a '#' symbol, and finally a hand with fingers spread and a '#' symbol with a downward-pointing arrow.</p>
crucify	<p>The SignWriting for 'crucify' consists of a hand with fingers spread and a '#' symbol with an arrow pointing left, followed by a hand with fingers spread and a '#' symbol with an arrow pointing right, and finally two hands with fingers spread.</p>
crucify	<p>The SignWriting for 'crucify' consists of a hand with fingers spread and a '#' symbol with an arrow pointing down, followed by a hand with fingers spread and a '#' symbol with an arrow pointing up, and finally two hands with fingers spread.</p>
crucify	<p>The SignWriting for 'crucify' consists of a hand with fingers spread and a '#' symbol with an arrow pointing left, followed by a hand with fingers spread and a '#' symbol with an arrow pointing right.</p>
crucify	<p>The SignWriting for 'crucify' consists of a hand with fingers spread and a '#' symbol with an arrow pointing down, followed by a hand with fingers spread and a '#' symbol with an arrow pointing up, and finally a hand with fingers spread and a '#' symbol with a downward-pointing arrow.</p>

ASL Bible Dictionary

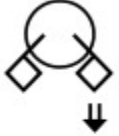
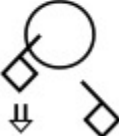
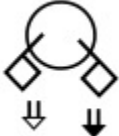
Spoken Word	SignWriting
crucify	<p>The signwriting for 'crucify' consists of three distinct parts. The top part is a circle with a horizontal line through its center, and two small arrows pointing up and down from the top and bottom of the circle. Below this is a diagonal line. The bottom part is a diamond shape with a horizontal line through its center, and a small arrow pointing to the left from the top of the diamond, with a hash symbol (#) below it.</p>
crush	<p>The signwriting for 'crush' consists of three parts. The top part is a diamond shape with a horizontal line through its center, and a hash symbol (#) to its left. The middle part is a diamond shape with a horizontal line through its center, and a small arrow pointing to the right from the top of the diamond. The bottom part is a diamond shape with a horizontal line through its center, and a small arrow pointing to the right from the top of the diamond, with a hash symbol (#) to its left.</p>
crush	<p>The signwriting for 'crush' consists of two parts. The top part is a diamond shape with a horizontal line through its center, and a small arrow pointing to the right from the top of the diamond. The bottom part is a diamond shape with a horizontal line through its center, and a hash symbol (#) to its left.</p>
crush	<p>The signwriting for 'crush' consists of three parts. The top part is a diamond shape with a horizontal line through its center, and a small arrow pointing to the right from the top of the diamond. The middle part is a diamond shape with a horizontal line through its center, and a small arrow pointing to the right from the top of the diamond, with a hash symbol (#) to its left. The bottom part is a diamond shape with a horizontal line through its center, and a small arrow pointing to the right from the top of the diamond.</p>
crush	<p>The signwriting for 'crush' consists of two parts. The top part is a diamond shape with a horizontal line through its center, and a small arrow pointing to the right from the top of the diamond. The bottom part is a diamond shape with a horizontal line through its center, and a small arrow pointing to the right from the top of the diamond, with a hash symbol (#) to its left.</p>

ASL Bible Dictionary

Spoken Word	SignWriting
crush	
cry	 
cry	
cry	
cry	
cry-out	







ASL Bible Dictionary

Spoken Word	SignWriting
crystal	<p>The SignWriting for 'crystal' consists of a vertical sequence of symbols: a circle with a horizontal line through its center, followed by a square with a diagonal line from the top-left to the bottom-right, then a square with a horizontal line through its center, a square with a vertical line through its center, a square with a horizontal line through its center, a square with a vertical line through its center, a square with a horizontal line through its center, a square with a vertical line through its center, and finally a square with a horizontal line through its center.</p>
CSDR	<p>The SignWriting for 'CSDR' consists of a vertical sequence of symbols: a circle with a horizontal line through its center, a square with a horizontal line through its center, a square with a vertical line through its center, and a square with a diagonal line from the top-left to the bottom-right.</p>
CSDR	<p>The SignWriting for 'CSDR' consists of a vertical sequence of symbols: a circle with a horizontal line through its center, a square with a horizontal line through its center, a square with a vertical line through its center, and a square with a diagonal line from the top-left to the bottom-right.</p>
cu	<p>The SignWriting for 'cu' consists of a vertical sequence of symbols: a circle with a horizontal line through its center, and a square with a horizontal line through its center.</p>
cube	<p>The SignWriting for 'cube' consists of a vertical sequence of symbols: a square with a diagonal line from the top-left to the bottom-right, a square with a vertical line through its center, and a square with a horizontal line through its center.</p>
cubits	<p>The SignWriting for 'cubits' consists of a vertical sequence of symbols: a circle with a horizontal line through its center, a square with a horizontal line through its center, a square with a vertical line through its center, a square with a diagonal line from the top-left to the bottom-right, a square with a horizontal line through its center, a square with a vertical line through its center, a square with a horizontal line through its center, a square with a vertical line through its center, a square with a horizontal line through its center, and finally a square with a vertical line through its center.</p>

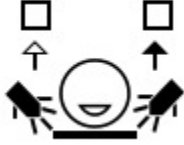
ASL Bible Dictionary

Spoken Word	SignWriting
cult	<p>The sign for 'cult' is written vertically. It starts with a circle containing a horizontal line, followed by a horizontal line, a vertical line, a horizontal line, a vertical line, and a horizontal line.</p>
cult	<p>The sign for 'cult' is written vertically. It starts with a circle containing a horizontal line and a vertical line, followed by a horizontal line, a vertical line, a horizontal line, and a vertical line.</p>
culture	<p>The sign for 'culture' is written vertically. It starts with a circle containing a horizontal line and a vertical line, followed by a horizontal line, a vertical line, a horizontal line, and a vertical line.</p>
culture	<p>The sign for 'culture' is written vertically. It starts with a circle containing a horizontal line and a vertical line, followed by a horizontal line, a vertical line, a horizontal line, a vertical line, a horizontal line, and a vertical line.</p>
cup	<p>The sign for 'cup' is written vertically. It starts with a horizontal line, followed by a vertical line, and a horizontal line.</p>
cups	<p>The sign for 'cups' is written vertically. It starts with a horizontal line, followed by a vertical line, and a horizontal line, with an asterisk above the vertical line. This is followed by a horizontal line, a vertical line, and a horizontal line, with an asterisk above the vertical line.</p>

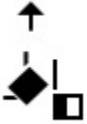
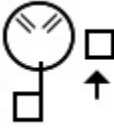
ASL Bible Dictionary

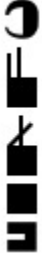
Spoken Word	SignWriting
cured	
curious	
currents	
curriculum	
curse	
curse	
curse	
curse	









ASL Bible Dictionary

Spoken Word	SignWriting
curses	<p>The signwriting for 'curses' consists of a diamond shape with an arrow pointing up and to the right, and another diamond shape below it with an arrow pointing up and to the left.</p>
cursing	<p>The signwriting for 'cursing' features a circle on the left with a line extending down to a square, and two squares on the right with two upward-pointing arrows between them.</p>
curtain	<p>The signwriting for 'curtain' shows two hands with fingers spread, each with a curved arrow pointing outwards from the hand.</p>
Cush	<p>The signwriting for 'Cush' is a vertical sequence of symbols: a circle, a horizontal line, a square, and another square.</p>
Cushan	<p>The signwriting for 'Cushan' is a vertical sequence of symbols: a circle, a horizontal line, a square, another square, and a hand with fingers spread.</p>
customer	<p>The signwriting for 'customer' is a vertical sequence of symbols: a circle with a horizontal line, an asterisk, a double-headed arrow, another asterisk, a hand with fingers spread, and a double-headed arrow.</p>



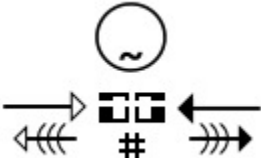

ASL Bible Dictionary

Spoken Word	SignWriting
customers	<p>The signwriting for 'customers' consists of two vertical sequences of symbols. The left sequence starts with a circle containing a 'C', followed by an asterisk, a downward arrow, and another asterisk. The right sequence starts with a circle containing a 'U', followed by an asterisk, a downward arrow, and another asterisk. Below these are two identical symbols, each consisting of a vertical bar with an upward arrow and a rightward arrow at the bottom.</p>
customs	<p>The signwriting for 'customs' consists of a single symbol: a vertical bar with a downward arrow and a rightward arrow at the bottom.</p>
cut	<p>The signwriting for 'cut' consists of a diagonal line with a downward arrow and a rightward arrow at the bottom.</p>
cut	<p>The signwriting for 'cut' consists of a vertical bar with a downward arrow and a rightward arrow at the bottom.</p>
cut	<p>The signwriting for 'cut' consists of two identical symbols. Each symbol starts with a circle containing a tilde (~), followed by two parallel diagonal lines with downward arrows, and ends with two small squares.</p>
cut	<p>The signwriting for 'cut' consists of a diagonal line with a downward arrow and a rightward arrow at the bottom.</p>





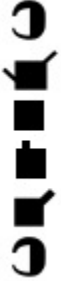

ASL Bible Dictionary

Spoken Word	SignWriting
cut	
cut off	
cut off	
cutting	
cv	
cycle	
cymbal	
cymbals	





ASL Bible Dictionary

Spoken Word	SignWriting
Cyprus	
Cyrene	
Cyrus	
cystic	
d	
D	







ASL Bible Dictionary

Spoken Word	SignWriting
dac	
dad	
dad	
Dagon	
daily	
Dalmanutha	

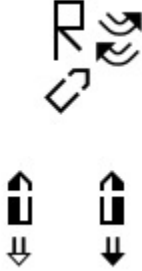

ASL Bible Dictionary

Spoken Word	SignWriting
Dalphon	
Damaris	
Damascus	
damned	





ASL Bible Dictionary

Spoken Word	SignWriting
dan	
Dana	
dance	
dancer	
danger	
Daniel	
Daniel	



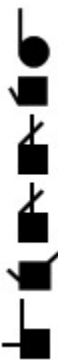
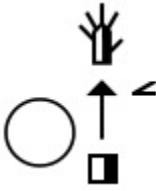

ASL Bible Dictionary

Spoken Word	SignWriting
Daniel	 The SignWriting for 'Daniel' consists of a circle with two diagonal lines inside, a vertical line with a dot, and a vertical line with an upward-pointing arrow.
DanielThanks02	
Danish	 The SignWriting for 'Danish' consists of a square with an arrow pointing right, followed by a wavy line with an arrow pointing right.
dare	 The SignWriting for 'dare' consists of a circle with two diagonal lines inside, a vertical line with a dot, and a vertical line with an upward-pointing arrow.





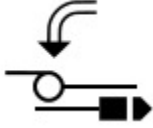
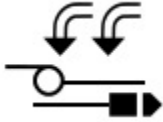

ASL Bible Dictionary

Spoken Word	SignWriting
Darius	
Darkon	
Darryl	
dart	
dash	

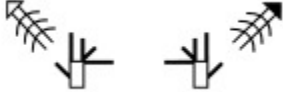





ASL Bible Dictionary

Spoken Word	SignWriting
David	
dawn	
dawn	
day	
days	
days	
Daytona	

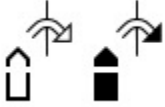





ASL Bible Dictionary

Spoken Word	SignWriting
dazzle	
db	
DC	
deacon	
deacons	
Dead	

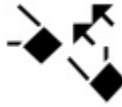

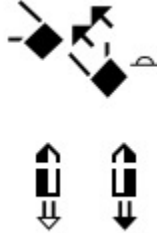
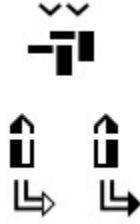

ASL Bible Dictionary

Spoken Word	SignWriting
death	
debate	
debaters	
Deborah	
debt	
deceit	
deceive	

ASL Bible Dictionary

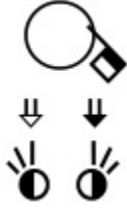
Spoken Word	SignWriting
deceive	
deceive	
deceive	
deceiver	
deceivers	
December	
decent	
deception	

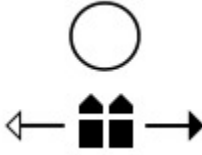
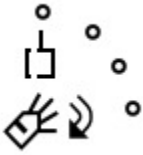

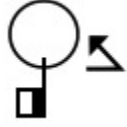



ASL Bible Dictionary

Spoken Word	SignWriting
decide	
decisions	
deck	
deck	
declaw	
decline	
decree	

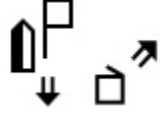
ASL Bible Dictionary

Spoken Word	SignWriting
Dedan	<p>The SignWriting for 'Dedan' consists of a vertical sequence of symbols: a horizontal line, a circle with a dot, a square with a dot, a square with a dot, a square with a dot, and a square with a dot.</p>
dedicated	<p>The SignWriting for 'dedicated' includes a circle with two arrows pointing towards each other, followed by two squares with arrows pointing outwards from their top corners.</p>
dedication	<p>The SignWriting for 'dedication' features two identical symbols, each consisting of a square with a dot and a hook-like shape extending from the top.</p>
dedication	<p>The SignWriting for 'dedication' is a vertical sequence of symbols: a horizontal line, a circle with a dot, a square with a dot, a square with a dot, a square with a dot, a square with a dot, a square with a dot, a square with a dot, a square with a dot, a square with a dot, and a square with a dot.</p>
deeds	<p>The SignWriting for 'deeds' includes two circles with arrows pointing towards each other, followed by four squares with arrows pointing outwards from their corners.</p>
deep	<p>The SignWriting for 'deep' consists of a square with a dot, a square with a dot, and a square with a dot.</p>







ASL Bible Dictionary

Spoken Word	SignWriting
deep	
deepest	
deer	
deer	
deer	
defeat	
defend	
Defense	

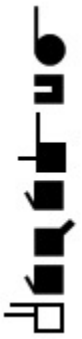

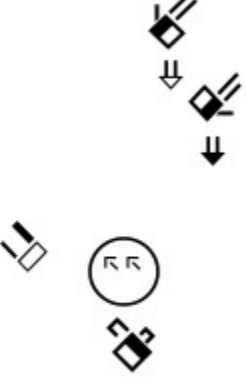

ASL Bible Dictionary

Spoken Word	SignWriting
defensiblespace	
defile	
deformed	
degree	
degree	
degrees	
Del Mar	



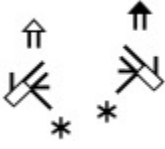

ASL Bible Dictionary

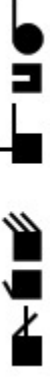
Spoken Word	SignWriting
Delaiah	
Delaware	
delete	
delete	
delete sign	
delicious	





ASL Bible Dictionary

Spoken Word	SignWriting
delight	
delight	
Delilah	
Delilah	
deliver	
delmar	

ASL Bible Dictionary

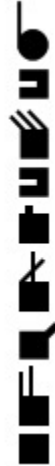
Spoken Word	SignWriting
demand	
demand	
demand	
Demas	
demetris	

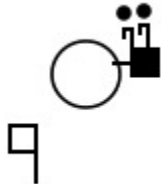
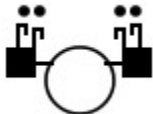

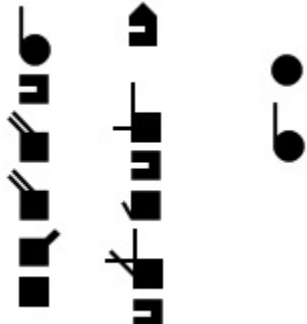



ASL Bible Dictionary

Spoken Word	SignWriting
Demetrius	
Democrats	
demon	
demon	
den	
Dennis Leake	

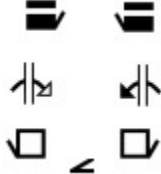

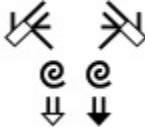
ASL Bible Dictionary

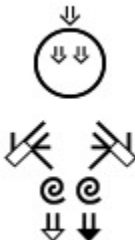
Spoken Word	SignWriting
dens	<p>The SignWriting for 'dens' consists of a vertical sequence of four symbols: a hand with the index finger pointing up, a square with a vertical line through its center, a square with a diagonal line from the top-left to the bottom-right, and a solid black square.</p>
deny	<p>The SignWriting for 'deny' consists of a central circle with four arrows pointing outwards to the top-left, top-right, bottom-left, and bottom-right. Below the top-left and bottom-left arrows are solid black diamonds.</p>
deny	<p>The SignWriting for 'deny' consists of a central circle with four arrows pointing outwards to the top-left, top-right, bottom-left, and bottom-right. Below the top-left and bottom-left arrows are solid black diamonds.</p>
department	<p>The SignWriting for 'department' consists of two identical symbols side-by-side. Each symbol features a hand with the index finger pointing up, a vertical line through the center, and a solid black circle at the bottom.</p>





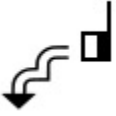
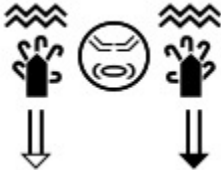
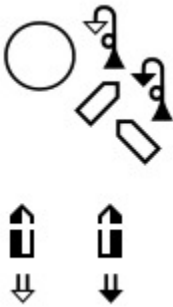
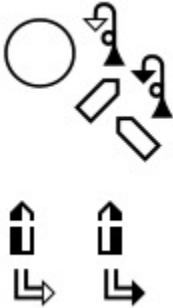

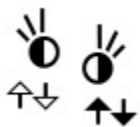
ASL Bible Dictionary

Spoken Word	SignWriting
depend	
deposit	
deposit	
depressed	
depression	
depression	
Derbe	

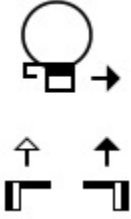



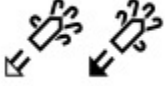
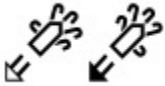
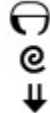

ASL Bible Dictionary

Spoken Word	SignWriting
descend	
descend	
descendant	
descendants	
descending-dove	
describe	

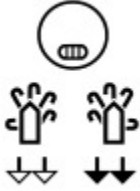

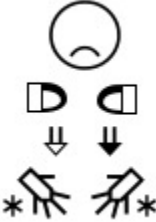

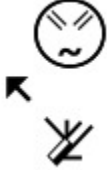
ASL Bible Dictionary

Spoken Word	SignWriting
desert	
deserve	
design	
desire	
desire God	
desire-above	
desires	
desires	

ASL Bible Dictionary

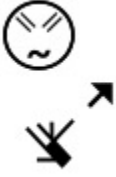
Spoken Word	SignWriting
desires	
desolate	
despair	
despise	
despise	
despise	





ASL Bible Dictionary

Spoken Word	SignWriting
despise	
dessert	
destroy	
destroy	
destroy	

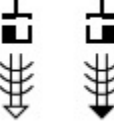

ASL Bible Dictionary

Spoken Word	SignWriting
destroyer	<p>The SignWriting for 'destroyer' consists of a central cluster of symbols: a hand with fingers spread, a hand with fingers curled, a hand with fingers spread, and a hand with fingers curled. Below this cluster are two separate symbols, each consisting of a hand with fingers spread and a hand with fingers curled.</p>
Destroyer	<p>The SignWriting for 'Destroyer' is a vertical sequence of symbols: a hand with fingers spread, a hand with fingers curled, a hand with fingers spread, a hand with fingers curled, a hand with fingers spread, a hand with fingers curled, a hand with fingers spread, and a hand with fingers curled.</p>
destroyers	<p>The SignWriting for 'destroyers' consists of a central cluster of symbols: a hand with fingers spread, a hand with fingers curled, a hand with fingers spread, and a hand with fingers curled. Below this cluster are two separate symbols, each consisting of a hand with fingers spread and a hand with fingers curled.</p>
destroys	<p>The SignWriting for 'destroys' consists of a central cluster of symbols: a hand with fingers spread, a hand with fingers curled, a hand with fingers spread, and a hand with fingers curled.</p>

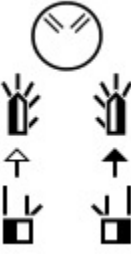

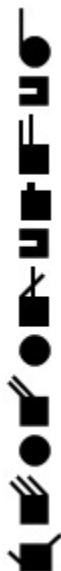

ASL Bible Dictionary

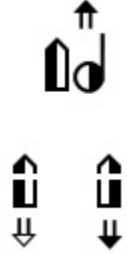
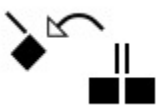
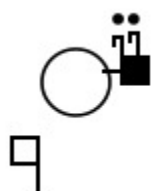
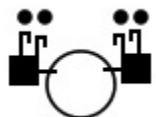
Spoken Word	SignWriting
detach	
details	
details	
deteriorate	
detests	
detests	



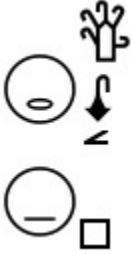
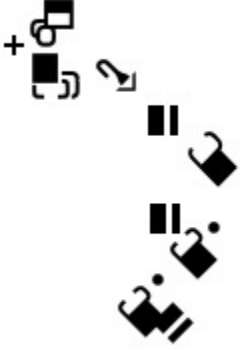
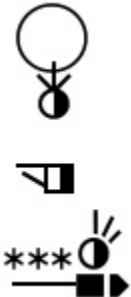



ASL Bible Dictionary

Spoken Word	SignWriting
Deuteronomy	
develop	
developer	
deviate	
devil	
devil	



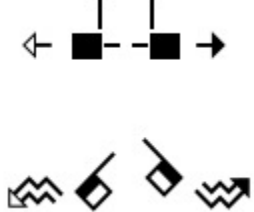



ASL Bible Dictionary

Spoken Word	SignWriting
devour	 <p>The signwriting for 'devour' consists of two parts. The first part shows a circle containing a horizontal line, with a hand icon above it. The second part shows a circle containing a horizontal line, with a small square to its right.</p>
devour-prey	 <p>The signwriting for 'devour-prey' is a complex sequence of symbols including a plus sign, a hand icon, a square, and several other geometric shapes and arrows arranged in a curved path.</p>
dew	 <p>The signwriting for 'dew' includes a circle with a horizontal line through it, a hand icon, a square, and a sun-like symbol with rays.</p>
dew	 <p>The signwriting for 'dew' consists of a hand icon, a square, and a circle with a horizontal line through it.</p>
DGS	 <p>The signwriting for 'DGS' consists of a hand icon, a square, and a solid black square.</p>
diabetes	 <p>The signwriting for 'diabetes' consists of a circle with a hand icon inside it, and a hand icon below it with three arrows pointing downwards.</p>

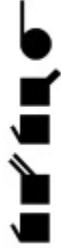





ASL Bible Dictionary

Spoken Word	SignWriting
diabetes	
diagnosis	
dialect	
diameter	
diamond	
diamond	

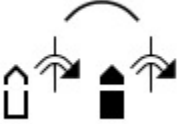



ASL Bible Dictionary

Spoken Word	SignWriting
Diana	
Diblain	
Dibon	
dice	
dice	
dictionary	

ASL Bible Dictionary

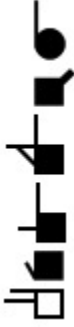
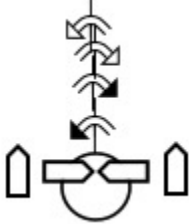
Spoken Word	SignWriting
die	
died	
died	
Diego	
different	
different	
different	
dig	
dig	





ASL Bible Dictionary

Spoken Word	SignWriting
Diklah	
dim	
Dinah	
dine	
Dinhabah	

ASL Bible Dictionary

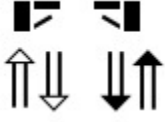
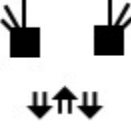
Spoken Word	SignWriting
dinner	<p>The SignWriting for 'dinner' consists of a circle with a diamond shape inside, followed by a downward arrow, and then a vertical line with a horizontal bar at the bottom.</p>
dinner	<p>The SignWriting for 'dinner' is identical to the previous entry, but includes two asterisks (**). The asterisks are positioned to the left of the circle.</p>
Dionysius	<p>The SignWriting for 'Dionysius' is a vertical sequence of symbols: a horizontal line, a circle with a dot, a square with a dot, a square with a diagonal line, a square with a horizontal line, a square with a vertical line, a square with a horizontal line, and a square with a horizontal line.</p>
Diotrephes	<p>The SignWriting for 'Diotrephes' is a vertical sequence of symbols: a horizontal line, a circle with a dot, a square with a dot, a square with a diagonal line, a square with a horizontal line, a square with a vertical line, a square with a horizontal line, a square with a horizontal line, and a square with a horizontal line.</p>
dip	<p>The SignWriting for 'dip' consists of a square with a horizontal line, followed by a downward arrow, and then an upward arrow.</p>



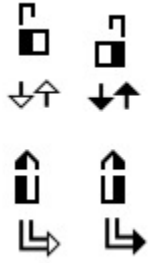



ASL Bible Dictionary

Spoken Word	SignWriting
dip	
dip	
dipped	
dipping	
direct	
direct	
directly	
directors	



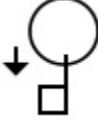
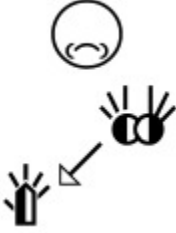
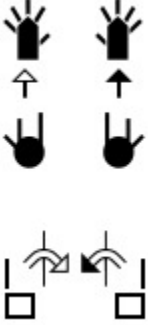



ASL Bible Dictionary

Spoken Word	SignWriting
dirt	<p>The signwriting for 'dirt' consists of two parts. The top part shows two small squares, each with a circle above it, representing the letters 'D' and 'I'. The bottom part shows two vertical bars with arrows pointing outwards from their bases, representing the letter 'R'.</p>
dirty	<p>The signwriting for 'dirty' shows a hand with fingers spread, with three wavy lines above it representing the letter 'D'. To the right is a circle representing the letter 'I'.</p>
dis	<p>The signwriting for 'dis' shows a hand with the index finger pointing up, with a circle above it representing the letter 'D'. Below this is a square representing the letter 'S'.</p>
disability	<p>The signwriting for 'disability' shows a hand with the index finger pointing up, with a circle above it representing the letter 'D'. Below this is a square representing the letter 'S'.</p>
disagree	<p>The signwriting for 'disagree' shows a circle representing the letter 'D' with a hand pointing to it. Below this is a horizontal line with a square on each end and arrows pointing outwards, representing the letter 'S'.</p>
disappear	<p>The signwriting for 'disappear' shows a hand with fingers spread, with a circle above it containing a starburst, representing the letter 'D'. To the right is a hand with fingers spread, representing the letter 'I'.</p>
disappear	<p>The signwriting for 'disappear' shows a hand with fingers spread, with a square below it representing the letter 'S'. Below the square is a double arrow pointing downwards, representing the letter 'P'.</p>

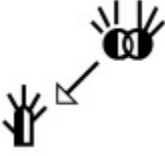

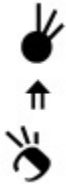
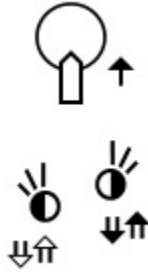
ASL Bible Dictionary

Spoken Word	SignWriting
disappear	
disappears	
disappoint	
disassociate	
disaster	
disciple	
disciple	
disciples	
disconnect	

ASL Bible Dictionary

Spoken Word	SignWriting
disconnect	
disconnect	
disconnect	
discover	
discretion	
discuss	
discuss	
diseases	

ASL Bible Dictionary

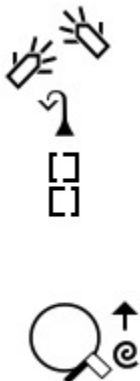
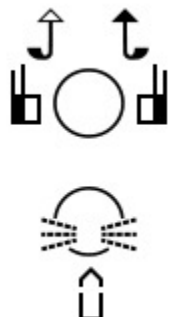
Spoken Word	SignWriting
disembark	
disembark	
disgrace	
disgrace	
disgrace	

ASL Bible Dictionary

Spoken Word	SignWriting
disgust	<p>The SignWriting for 'disgust' consists of two parts. The first part is a circle with a horizontal line through its center, an arrow pointing left from the top of the circle, and a vertical line extending downwards from the center. The second part is a vertical sequence of symbols: a small upward-pointing arrow, a square with a vertical line through its center, and a hand with fingers spread.</p>
Dishan	<p>The SignWriting for 'Dishan' is a vertical sequence of symbols: a horizontal line, a solid black circle, a square with a diagonal line from the top-left to the bottom-right, a square with a vertical line through its center, a square with a horizontal line through its center, and a hand with fingers spread.</p>
disheveled	<p>The SignWriting for 'disheveled' consists of two parts. The first part is a circle with a hand symbol inside, where the hand is positioned as if holding the top of the circle. The second part is a circle with a hand symbol inside, where the hand is positioned as if holding the side of the circle.</p>
disheveled	<p>The SignWriting for 'disheveled' consists of two parts. The first part is a circle with two hand symbols inside, one on the left and one on the right, as if holding the circle from both sides. The second part is a circle with two hand symbols inside, one on the left and one on the right, as if holding the circle from both sides.</p>
Dishon	<p>The SignWriting for 'Dishon' is a vertical sequence of symbols: a horizontal line, a solid black circle, a square with a diagonal line from the top-left to the bottom-right, a square with a vertical line through its center, a square with a horizontal line through its center, a solid black circle, a solid black circle, and a hand with fingers spread.</p>







ASL Bible Dictionary

Spoken Word	SignWriting
dishonor	<p>The signwriting for 'dishonor' consists of two parts. The first part shows two black dots with arrows pointing left and right, representing the word 'dish'. The second part shows a circle representing 'on', followed by two hand icons with arrows indicating movement, representing 'honor'.</p>
dishonor	<p>The signwriting for 'dishonor' consists of two parts. The first part shows two hand icons with arrows indicating movement, representing 'dish'. The second part shows a circle with a face-like expression, representing 'honor'.</p>
dismay-error	<p>The signwriting for 'dismay-error' shows a central face icon with two hand icons on either side, each with an arrow pointing towards the face, representing the concept of 'dismay' or 'error'.</p>
Disney	<p>The signwriting for 'Disney' is a vertical sequence of symbols: a circle, a hand icon, a hand icon, a hand icon, a hand icon, and a hand icon.</p>
Disneyland	<p>The signwriting for 'Disneyland' is a vertical sequence of symbols: a circle, a hand icon, a hand icon, a hand icon, a hand icon, and a hand icon.</p>
Disneyland	<p>The signwriting for 'Disneyland' is a vertical sequence of symbols: a circle, a hand icon, a hand icon, a hand icon, a hand icon, a hand icon, a hand icon, a hand icon, and a hand icon.</p>

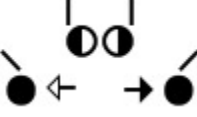



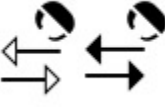
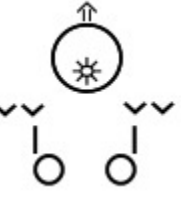
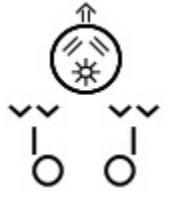

ASL Bible Dictionary

Spoken Word	SignWriting
disobey	<p>The signwriting for 'disobey' consists of two parts. The first part shows a circle with a downward arrow above it, followed by two squares, a downward arrow, and two hands with fingers spread. The second part shows a left arrow, a central diamond shape, and a right arrow.</p>
disreputable	<p>The signwriting for 'disreputable' consists of two parts. The first part shows a diamond shape with an arrow pointing to a circle, and another diamond shape with an arrow pointing to the circle. The second part shows a square and a diamond shape with an arrow pointing to the diamond.</p>
dissertations	<p>The signwriting for 'dissertations' consists of two vertical columns of symbols. The left column contains a diamond, a circle, a diamond, a diamond, a diamond, a diamond, and a diamond. The right column contains a diamond, a diamond, a diamond, a diamond, a diamond, a diamond, and a diamond.</p>
distinguish	<p>The signwriting for 'distinguish' consists of two parts. The first part shows a circle with two parallel lines inside, and a diamond shape with an arrow pointing to the circle. The second part shows two diamonds with arrows pointing to each other, and two diamonds with arrows pointing to each other.</p>
distraction	<p>The signwriting for 'distraction' consists of two parts. The first part shows a diamond shape with an arrow pointing to a diamond shape. The second part shows two parallel lines above two diamonds.</p>

ASL Bible Dictionary

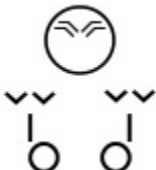
Spoken Word	SignWriting
divisions	
divorce	
DM	
do	
do	
do	
do	
do	
do	

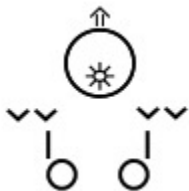
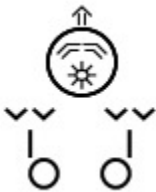
ASL Bible Dictionary

Spoken Word	SignWriting
do	
do	
do-do	
do-do	
do-do	
do-do	
dock	







ASL Bible Dictionary

Spoken Word	SignWriting
docs	<p>The sign for 'docs' is represented by a vertical sequence of symbols: a hook-like shape, a solid black circle, another solid black circle, a solid black square, and a solid black rectangle.</p>
doctor	<p>The sign for 'doctor' is represented by a hook-like shape with a solid black circle to its left, and a square with an arrow pointing to the right below it.</p>
doctor	<p>The sign for 'doctor' is represented by a hook-like shape with a solid black circle to its left, a square with an arrow pointing to the right below it, and two asterisks (**). Below the asterisks is a solid black circle.</p>
doctor	<p>The sign for 'doctor' is represented by a hook-like shape with a solid black circle to its left, a square with an arrow pointing to the right below it, and two asterisks (**). Below the asterisks is a solid black circle.</p>
doctrine	<p>The sign for 'doctrine' is represented by two upward-pointing arrows above two circles, with a larger circle below them containing two horizontal lines.</p>
Dodanim	<p>The sign for 'Dodanim' is represented by a vertical sequence of symbols: a hook-like shape, a solid black circle, another solid black circle, a solid black square, a solid black rectangle, a solid black square, a solid black rectangle, and a solid black rectangle.</p>
dog	<p>The sign for 'dog' is represented by two vertical lines, a hook-like shape with a solid black circle to its left and a square with an arrow pointing to the right below it, and a solid black circle below that. Below these are two squares, one with an arrow pointing to the right and one with an arrow pointing to the left.</p>



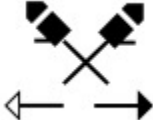

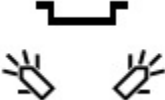

ASL Bible Dictionary

Spoken Word	SignWriting
dog	<p>The sign for 'dog' is composed of three elements: a square with a horizontal line above it, a diamond with a diagonal line from top-left to bottom-right, and a circle with a horizontal line through its center.</p>
dogs	<p>The sign for 'dogs' consists of two parts. The first part is a vertical line, followed by a diamond with a horizontal line above it and an arrow pointing to the right. The second part is a vertical sequence of three identical 'dog' signs.</p>
dogs	<p>The sign for 'dogs' is a vertical sequence of three identical 'dog' signs.</p>
dollar	<p>The sign for 'dollar' is a diamond with a horizontal line above it and an arrow pointing up and to the right.</p>
dollars	<p>The sign for 'dollars' is a diamond with a horizontal line above it, an arrow pointing up and to the right, and a second arrow pointing up and to the right from the tip of the first arrow.</p>
Dominican Republic	<p>The sign for 'Dominican Republic' is a circle with a horizontal line through its center, containing an equals sign. Below the circle is a square with a horizontal line above it.</p>

ASL Bible Dictionary

Spoken Word	SignWriting
don't	
don't	
don't	
don't	
don't know	
don't know	
don't know	
don't know	





ASL Bible Dictionary

Spoken Word	SignWriting
don't know	
don't know	
don't-care	
don't-want	
dont	
dont	
dont	



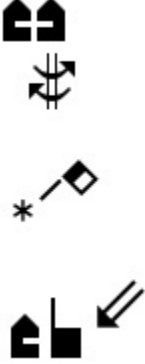

ASL Bible Dictionary

Spoken Word	SignWriting
dont	<p>The sign for 'dont' is composed of three parts: a face with a closed mouth and a slight frown, a hand with fingers crossed, and a horizontal double-headed arrow below.</p>
dont-care	<p>The sign for 'dont-care' consists of a hand with fingers spread pointing up, positioned above a circle with a hand pointing to the right.</p>
dont-care	<p>The sign for 'dont-care' consists of a circle with a hand pointing to the right, followed by a hand with fingers spread pointing up.</p>
dont-know	<p>The sign for 'dont-know' consists of a circle with a hand pointing to the right, flanked by two hands with fingers spread pointing up and down.</p>
dont-know	<p>The sign for 'dont-know' consists of a circle with a hand pointing to the right, followed by a hand with fingers spread pointing up.</p>
dont-like	<p>The sign for 'dont-like' consists of a hand with fingers spread pointing up, followed by a hand with fingers spread pointing down, and a hand with fingers spread pointing up.</p>
dont-like	<p>The sign for 'dont-like' consists of a hand with fingers spread pointing up, followed by a hand with fingers spread pointing down, and a hand with fingers spread pointing up.</p>





ASL Bible Dictionary

Spoken Word	SignWriting
dont-surprised	
door	
door	
door-close	

ASL Bible Dictionary

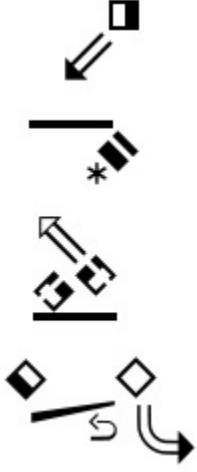
Spoken Word	SignWriting
doors	
Dorcas	
doses	
Dothan	
double	







ASL Bible Dictionary

Spoken Word	SignWriting
<p>double bong mongee</p>	
<p>double bong mongee</p>	
<p>doubt</p>	
<p>dough</p>	

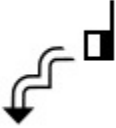



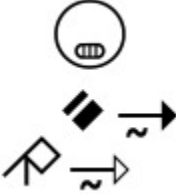
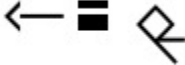

ASL Bible Dictionary

Spoken Word	SignWriting
dove	<p>The signwriting for 'dove' consists of a vertical line of three circles, followed by a vertical line of three horizontal bars, and a vertical line of three horizontal bars.</p>
doves	<p>The signwriting for 'doves' is identical to 'dove', consisting of a vertical line of three circles, followed by a vertical line of three horizontal bars, and a vertical line of three horizontal bars.</p>
down	<p>The signwriting for 'down' is a diagonal line with a square at the top right and an arrow pointing down and to the left.</p>
down	<p>The signwriting for 'down' is a vertical line with a square at the top right and a double arrow pointing down.</p>
down-down	<p>The signwriting for 'down-down' consists of two vertical lines. Each line starts with a hand icon (palm up) and ends with a zigzag line.</p>
down-into-water	<p>The signwriting for 'down-into-water' consists of a vertical line with a square at the top right, followed by a diagonal line with a square at the top right and an arrow pointing down and to the left, and a vertical line with a square at the top right and a double arrow pointing down.</p>
download	<p>The signwriting for 'download' consists of a vertical line with a square at the top right and an arrow pointing down and to the left, followed by a vertical line with a square at the top right and a double arrow pointing down, and a vertical line with a square at the top right and a double arrow pointing down.</p>



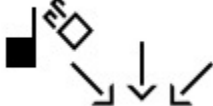

ASL Bible Dictionary

Spoken Word	SignWriting
downstairs	
downtown	
doze	
drag	
drag	
drag	
dragon	



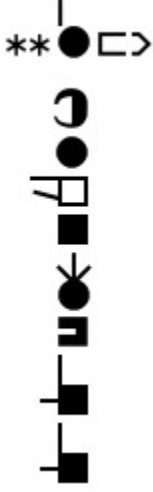

ASL Bible Dictionary

Spoken Word	SignWriting
dragon	
dragon	
dragon	
dragon	
draw	
draw	
draw	
draw-to-myself	

ASL Bible Dictionary

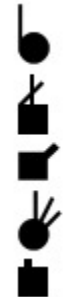
Spoken Word	SignWriting
draw-water	 <p>The SignWriting for 'draw-water' in this row consists of a vertical line on the left. To its right, there are two sets of symbols. The upper set includes a small square with a dot above it, a wavy line, and an arrow pointing down and to the right. The lower set includes a similar square with a dot, a wavy line, and an arrow pointing down and to the right.</p>
draw-water	 <p>The SignWriting for 'draw-water' in this row features a vertical line on the right side. To its left, there are two sets of symbols. The upper set includes a square with a dot above it, a wavy line, and an arrow pointing down and to the left. The lower set includes a similar square with a dot, a wavy line, and an arrow pointing down and to the left.</p>
DrCogswell	 <p>The SignWriting for 'DrCogswell' is a vertical sequence of symbols. From top to bottom: a horizontal line, a square with a dot above it, a square with a dot above it and an arrow pointing right, a circle with a dot above it, a square with a dot above it, a square with a dot above it and an arrow pointing right, a square with a dot above it and an arrow pointing right, a square with a dot above it and an arrow pointing right, a square with a dot above it and an arrow pointing right, and finally a square with a dot above it and an arrow pointing right.</p>
dream	 <p>The SignWriting for 'dream' in this row includes a circle on the left. To its right, there are two sets of symbols. The upper set includes a square with a dot above it and an arrow pointing down and to the right. The lower set includes a square with a dot above it and an arrow pointing down and to the right.</p>
dream	 <p>The SignWriting for 'dream' in this row includes a circle with a smiley face on the left. To its right, there are two sets of symbols. The upper set includes a square with a dot above it and an arrow pointing down and to the right. The lower set includes a square with a dot above it and an arrow pointing down and to the right.</p>

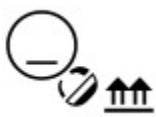

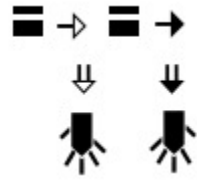
ASL Bible Dictionary

Spoken Word	SignWriting
dreams	
drift	
drink	
drinking	
drip	
drip	
drop to right	

ASL Bible Dictionary

Spoken Word	SignWriting
drought	<p>The signwriting for 'drought' consists of a vertical sequence of symbols: a circle with a line extending upwards, a square with a diagonal line, a circle, a square with a horizontal line, a square with a vertical line, a square with a diagonal line, and a square.</p>
drown	<p>The signwriting for 'drown' consists of a square with a diagonal line, a square, and a wavy line.</p>
drugs	<p>The signwriting for 'drugs' consists of a square with a diagonal line, a square with a diagonal line, and a square with a diagonal line.</p>
drum	<p>The signwriting for 'drum' consists of two symbols: a square with a diagonal line and a square with a diagonal line, and a square with a diagonal line and a square with a diagonal line.</p>
drunk	<p>The signwriting for 'drunk' consists of a circle, a square with a diagonal line, and a square with a diagonal line.</p>
drunk	<p>The signwriting for 'drunk' consists of a circle, a square with a diagonal line, and a square with a diagonal line.</p>
drunk	<p>The signwriting for 'drunk' consists of a circle, a square with a diagonal line, and a square with a diagonal line.</p>

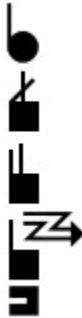
ASL Bible Dictionary

Spoken Word	SignWriting
Drusilla	
Druze	
dry	
drydock	





ASL Bible Dictionary

Spoken Word	SignWriting
due	
duke	
dukes	
Dumah	
dumb	
Dung	



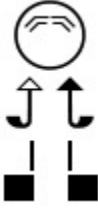

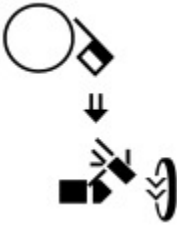
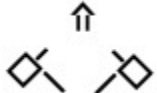

ASL Bible Dictionary

Spoken Word	SignWriting
dung	<p>The sign for 'dung' is written vertically. It starts with a circle on the right side, followed by a square with a horizontal line through its center, then a square with a diagonal line from the top-left to the bottom-right, and finally a square with a vertical line through its center.</p>
dungeon	<p>The sign for 'dungeon' is written vertically. It starts with a circle on the right side, followed by a square with a horizontal line through its center, then a square with a diagonal line from the top-left to the bottom-right, then a square with a vertical line through its center, and ends with a circle on the right side.</p>
Dura	<p>The sign for 'Dura' is written vertically. It starts with a circle on the right side, followed by a square with a horizontal line through its center, then a square with a diagonal line from the top-left to the bottom-right, and ends with a square with a vertical line through its center.</p>
during	<p>The sign for 'during' is written horizontally. It consists of two identical units side-by-side. Each unit has a square at the bottom with an upward-pointing arrow, and a hook-like shape above it that curves to the right.</p>
during	<p>The sign for 'during' is written horizontally. It starts with a circle containing two parallel diagonal lines, followed by two identical units side-by-side. Each unit has a square at the bottom with an upward-pointing arrow, and a hook-like shape above it that curves to the right.</p>
during	<p>The sign for 'during' is written horizontally. It starts with a circle containing two parallel diagonal lines, followed by two identical units side-by-side. Each unit has a square at the bottom with a diagonal arrow pointing up and to the right.</p>

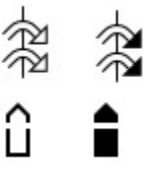
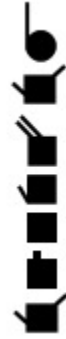





ASL Bible Dictionary

Spoken Word	SignWriting
during	
duty	
DVD	
dwell	
dwell	
dwell-on	
dwelt	

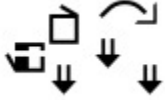
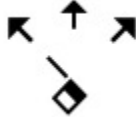



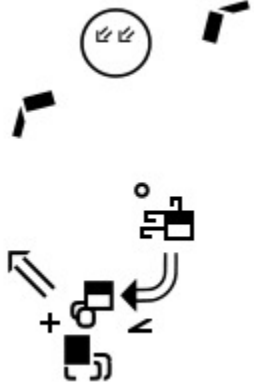



ASL Bible Dictionary

Spoken Word	SignWriting
dying	
dying	
dynasty	
dysentery	
E	
e-down	
each	
each	

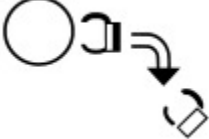
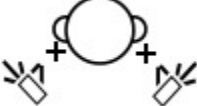
ASL Bible Dictionary

Spoken Word	SignWriting
each	
each-of-you	
each-other	
eager	
eager	
eager	
eagle	
eagle	

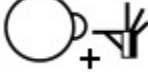

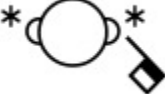

ASL Bible Dictionary

Spoken Word	SignWriting
ear	
ear-lean	
ear-off	
earings	
early	
early	
earn	
earring	
earrings	
ears	

ASL Bible Dictionary

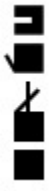
Spoken Word	SignWriting
ears	 The SignWriting symbol for 'ears' consists of two hands positioned above a circle. Each hand has its index and middle fingers extended and spread apart, with the thumb tucked in. The hands are oriented towards each other, with the palms facing outwards. Below the hands is a large circle, which represents the mouth or the point of articulation for the sign.

ASL Bible Dictionary

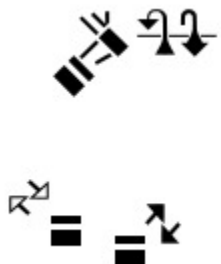
Spoken Word	SignWriting
ears	
ears	
ears	
earth	
earth	
earth	
earthquake	







ASL Bible Dictionary

Spoken Word	SignWriting
earthquake	<p>The signwriting for 'earthquake' consists of three main components. The top component is a hand with fingers spread, moving from a high position down and to the right, then curving back up and to the right. Below this are two separate signs, each consisting of a hand with fingers spread moving from a high position down and to the right, then curving back up and to the right, with a small square below each hand.</p>
earthquakes	<p>The signwriting for 'earthquakes' consists of three main components. The top component is a hand with fingers spread, moving from a high position down and to the right, then curving back up and to the right. Below this are two separate signs, each consisting of a hand with fingers spread moving from a high position down and to the right, then curving back up and to the right, with a small square below each hand. At the bottom right, there are two more separate signs, each consisting of a hand with fingers spread moving from a high position down and to the right, then curving back up and to the right, with a small square below each hand.</p>
easier	<p>The signwriting for 'easier' consists of two main components. The top component is a hand with fingers spread, moving from a high position down and to the right, then curving back up and to the right. Below this is a single sign consisting of a hand with fingers spread moving from a high position down and to the right, then curving back up and to the right, with a small square below the hand.</p>
East	<p>The signwriting for 'East' consists of a single sign consisting of a hand with fingers spread, moving from a high position down and to the right, then curving back up and to the right, with a small square below the hand.</p>
east	<p>The signwriting for 'east' consists of a single sign consisting of a hand with fingers spread, moving from a high position down and to the right, then curving back up and to the right, with a small square below the hand.</p>
Easter	<p>The signwriting for 'Easter' consists of a single sign consisting of a hand with fingers spread, moving from a high position down and to the right, then curving back up and to the right, with a small square below the hand.</p>
easy	<p>The signwriting for 'easy' consists of two main components. The top component is a hand with fingers spread, moving from a high position down and to the right, then curving back up and to the right. Below this is a single sign consisting of a hand with fingers spread moving from a high position down and to the right, then curving back up and to the right, with a small square below the hand.</p>





ASL Bible Dictionary

Spoken Word	SignWriting
easy do	<p>The signwriting for 'easy do' consists of a face with a sad expression (downward curved mouth) and a downward arrow above it, indicating a downward movement. Below the face are two hands, each with a downward arrow pointing towards the center, indicating a downward movement of both hands.</p>
eat	<p>The signwriting for 'eat' shows a hand holding a spoon and moving it towards a circular shape representing a mouth. Below the mouth are two hands, one with a downward arrow and one with an upward arrow, indicating a downward and upward movement.</p>
eat	<p>The signwriting for 'eat' shows a hand holding a spoon and moving it towards a circular shape representing a mouth. Below the mouth are two asterisks (**), indicating a specific movement or emphasis.</p>
eat	<p>The signwriting for 'eat' shows a hand holding a spoon and moving it towards a circular shape representing a mouth. Below the mouth are two asterisks (**), indicating a specific movement or emphasis.</p>
eat	<p>The signwriting for 'eat' shows a hand holding a spoon and moving it towards a circular shape representing a mouth.</p>
eat	<p>The signwriting for 'eat' shows a hand holding a spoon and moving it towards a circular shape representing a mouth. Below the mouth are four asterisks (****), indicating a specific movement or emphasis.</p>
eating	<p>The signwriting for 'eating' shows a hand holding a spoon and moving it towards a circular shape representing a mouth. Below the mouth are two hands, one with a downward arrow and one with an upward arrow, indicating a downward and upward movement.</p>
Ebal	<p>The signwriting for 'Ebal' consists of a vertical sequence of four downward arrows, indicating a downward movement.</p>





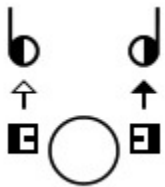

ASL Bible Dictionary

Spoken Word	SignWriting
Eber	
economy	
Edar	
Eden	
edge	
Edinburgh	

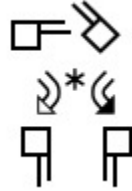

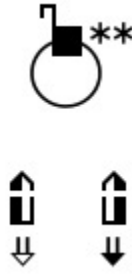

ASL Bible Dictionary

Spoken Word	SignWriting
Edison	
editor	
Edom	
Edomites	
education	





ASL Bible Dictionary

Spoken Word	SignWriting
Edward	
egg	
Egypt	
Egyptian	
Ehi	
Eight	
either	

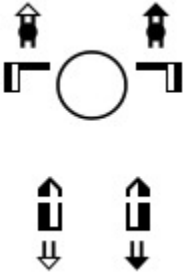

ASL Bible Dictionary

Spoken Word	SignWriting
El Salvador	
Elah	
Elam	
Elamites	
Elbethel	





ASL Bible Dictionary

Spoken Word	SignWriting
Eldaah	 <p>The signwriting for 'Eldaah' is a vertical sequence of six symbols: a square with a horizontal line on top, a square with a horizontal line on the left, a circle, a square with a diagonal line from top-left to bottom-right, and a square with a horizontal line on the bottom.</p>
elder	 <p>The signwriting for 'elder' consists of two parts. The top part features a central circle with two small house-like symbols above it and two L-shaped symbols on the left and right. The bottom part features two vertical double-headed arrows, one on the left and one on the right.</p>
elder	 <p>The signwriting for 'elder' is a vertical sequence of six symbols: a square with a horizontal line on top, a square with a horizontal line on the left, a circle, a square with a diagonal line from top-left to bottom-right, a square with a horizontal line on the bottom, and a square with a horizontal line on the bottom.</p>
elders	 <p>The signwriting for 'elders' is a vertical sequence of seven symbols: a square with a horizontal line on top, a square with a horizontal line on the left, a circle, a square with a diagonal line from top-left to bottom-right, a square with a horizontal line on the bottom, a square with a horizontal line on the bottom, and a square with a horizontal line on the bottom.</p>
elders	 <p>The signwriting for 'elders' consists of two parts. The top part features a central circle with two small house-like symbols above it and two L-shaped symbols on the left and right. The bottom part features two vertical double-headed arrows, one on the left and one on the right, with a small L-shaped arrow pointing right at the bottom of each.</p>



ASL Bible Dictionary

Spoken Word	SignWriting
<p>Eleazar</p>	 <p>The SignWriting for 'Eleazar' consists of a vertical sequence of signs: 'E', 'L', 'A', 'Z', 'A', 'R'. Each letter is represented by a square with a horizontal line above it. The 'Z' sign includes a zigzag arrow pointing to the right.</p>
<p>elect</p>	 <p>The SignWriting for 'elect' consists of a vertical sequence of signs: 'E', 'L', 'E', 'C', 'T'. The 'E' is a square with a horizontal line above it. The 'L' is a square with a horizontal line above it. The 'E' is a square with a horizontal line above it. The 'C' is a square with a horizontal line above it. The 'T' is a square with a horizontal line above it and a vertical line to its right.</p>
<p>Elelohe-Israel</p>	 <p>The SignWriting for 'Elelohe-Israel' consists of a vertical sequence of signs: 'E', 'L', 'L', 'O', 'H', 'E', 'I', 'S', 'R', 'A', 'E', 'L'. Each letter is represented by a square with a horizontal line above it. The 'O' sign includes a circle inside the square.</p>



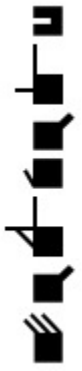
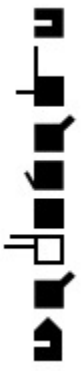

ASL Bible Dictionary

Spoken Word	SignWriting
EleloheIsrael	
elevate	
Eli	
Eliab	





ASL Bible Dictionary

Spoken Word	SignWriting
Eliakim	
Eliashib	
Eliezer	
Elijah	



ASL Bible Dictionary

Spoken Word	SignWriting
Elijah	
Elimelech	
eliminate	
Elioenai	
Eliphaz	

ASL Bible Dictionary

Spoken Word	SignWriting
Elisha	
Elishah	
Eliud	
Elizabeth	

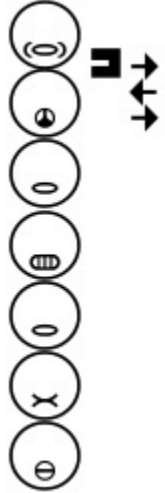
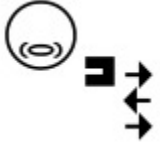
ASL Bible Dictionary

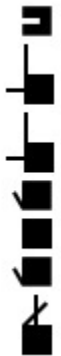
Spoken Word	SignWriting
Elizabeth	
Elizabeth	
Elizabeth	
Elkosh	
Ellasar	

ASL Bible Dictionary

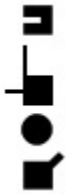
Spoken Word	SignWriting
Ellery	
Elmadam	
Eloi	
Elon	
Elparan	







ASL Bible Dictionary

Spoken Word	SignWriting
else	<p>The SignWriting for 'else' consists of a square with a horizontal line through its center. From the top-right corner of the square, a curved arrow points upwards and to the right. To the right of the square is another square with a horizontal line through its center.</p>
Elymas	<p>The SignWriting for 'Elymas' is a vertical sequence of seven symbols: a square with a horizontal line, a square with a horizontal line and a vertical line extending upwards from its center, a square with a horizontal line and a diagonal line extending from the top-left to the bottom-right, a square with a horizontal line and a diagonal line extending from the top-right to the bottom-left, a square with a horizontal line, a square with a horizontal line, and a solid black circle.</p>
embalmed	<p>The SignWriting for 'embalmed' is a vertical sequence of seven symbols: a square with a horizontal line, a square with a horizontal line and a diagonal line extending from the top-left to the bottom-right, a square with a horizontal line and a diagonal line extending from the top-right to the bottom-left, a square with a horizontal line, a square with a horizontal line, a square with a horizontal line, and a solid black circle.</p>
embarrass	<p>The SignWriting for 'embarrass' features a central circle. Two hands are positioned around the circle, with fingers spread. Below the circle are two small triangles, one pointing left and one pointing right.</p>
embarrassed	<p>The SignWriting for 'embarrassed' consists of two parts. The top part shows a circle with a cross inside, a square with a horizontal line, and a downward-pointing arrow. The bottom part shows two hands with fingers spread, one on the left and one on the right, with a circle between them. Below each hand is a small triangle pointing upwards.</p>

ASL Bible Dictionary

Spoken Word	SignWriting
embassies	<p>The sign for 'embassies' is written vertically. It starts with the letter 'E' (hand flat, palm up), followed by 'M' (hand flat, palm up, fingers spread), 'B' (hand flat, palm up, fingers spread), 'A' (hand flat, palm up, fingers spread), 'S' (hand flat, palm up, fingers spread), 'S' (hand flat, palm up, fingers spread), 'I' (hand flat, palm up, fingers spread), and 'E' (hand flat, palm up, fingers spread).</p>
embed	<p>The sign for 'embed' is written vertically. It starts with 'E' (hand flat, palm up, fingers spread), followed by 'M' (hand flat, palm up, fingers spread), 'B' (hand flat, palm up, fingers spread), and 'E' (hand flat, palm up, fingers spread). Below the 'E' is a small asterisk symbol.</p>
emerald	<p>The sign for 'emerald' is written vertically. It starts with 'E' (hand flat, palm up, fingers spread), followed by 'M' (hand flat, palm up, fingers spread), 'E' (hand flat, palm up, fingers spread), 'R' (hand flat, palm up, fingers spread), 'A' (hand flat, palm up, fingers spread), 'L' (hand flat, palm up, fingers spread), and 'D' (hand flat, palm up, fingers spread).</p>
emerg	<p>The sign for 'emerg' is written vertically. It starts with 'E' (hand flat, palm up, fingers spread), followed by 'M' (hand flat, palm up, fingers spread), 'E' (hand flat, palm up, fingers spread), 'R' (hand flat, palm up, fingers spread), and 'G' (hand flat, palm up, fingers spread).</p>
EMG	<p>The sign for 'EMG' is written vertically. It starts with 'E' (hand flat, palm up, fingers spread), followed by 'M' (hand flat, palm up, fingers spread), and 'G' (hand flat, palm up, fingers spread).</p>
EMG	<p>The sign for 'EMG' is written vertically. It starts with 'E' (hand flat, palm up, fingers spread), followed by 'M' (hand flat, palm up, fingers spread), and 'G' (hand flat, palm up, fingers spread). There are small asterisk symbols on either side of the 'G'.</p>
Emily	<p>The sign for 'Emily' is written vertically. It starts with 'E' (hand flat, palm up, fingers spread), followed by 'M' (hand flat, palm up, fingers spread), 'I' (hand flat, palm up, fingers spread), 'L' (hand flat, palm up, fingers spread), 'Y' (hand flat, palm up, fingers spread), and 'I' (hand flat, palm up, fingers spread).</p>

ASL Bible Dictionary

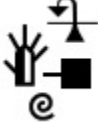
Spoken Word	SignWriting
Emims	
Emmaus	
emotion	
emotions	
emperor	
emphasis	
emphasis	



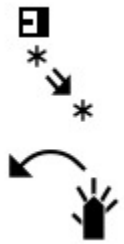



ASL Bible Dictionary

Spoken Word	SignWriting
empire	 The SignWriting for the word 'empire' consists of several components: a square icon with a smaller square inside, a downward-pointing arrow, two asterisks, a curved arrow pointing left, and a hand icon with fingers spread.

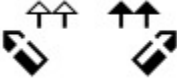

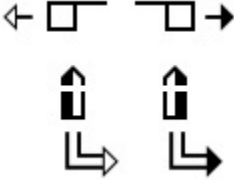
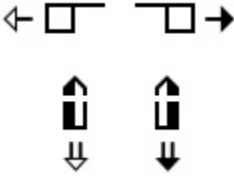





ASL Bible Dictionary

Spoken Word	SignWriting
empire	<p>The SignWriting for 'empire' consists of a vertical sequence of six symbols: a square with a horizontal line, a hand with fingers spread, a diamond with a diagonal line, a square with a diagonal line, a hand with fingers spread, and a square with a horizontal line.</p>
empower	<p>The SignWriting for 'empower' consists of a square with a circle inside, and an arrow pointing from the circle towards the top right.</p>
empty	<p>The SignWriting for 'empty' consists of a diamond with a diagonal line, a hand with fingers spread, and an arrow pointing towards the top right.</p>
EMS	<p>The SignWriting for 'EMS' consists of a vertical sequence of three symbols: a square with a horizontal line, a hand with fingers spread, and a square.</p>
enchanter	<p>The SignWriting for 'enchanter' consists of a vertical sequence of five symbols: a hand with fingers spread, a hand with fingers spread, a double arrow pointing down, and two curved arrows pointing outwards.</p>
encounter	<p>The SignWriting for 'encounter' consists of two vertical arrows pointing up, with two curved arrows pointing outwards from the base of each vertical arrow.</p>
encourage	<p>The SignWriting for 'encourage' consists of a central circle with a downward arrow and an upward arrow, with two upward arrows pointing towards the circle from below, and two hands with fingers spread pointing towards the circle from below.</p>



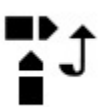

ASL Bible Dictionary

Spoken Word	SignWriting
encourages	
end	
endure	
enemies	
enemy	
energy	
engaged	
engine	
English	



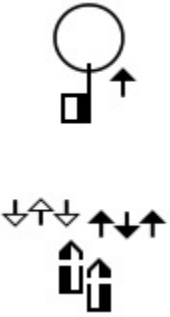

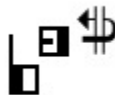
ASL Bible Dictionary

Spoken Word	SignWriting
Enoch	
Enosh	
enough	
enough	
enter	
enter	
enter	
enter	
enter	



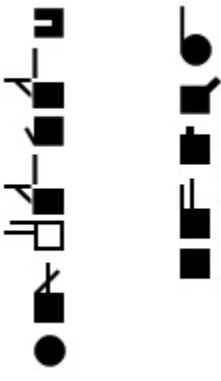

ASL Bible Dictionary

Spoken Word	SignWriting
enter-heaven	
enthusiasm	
enthusiasm	
entice	
environment	
envy	
Epaphras	





ASL Bible Dictionary

Spoken Word	SignWriting
Epaphroditus	 <p>The SignWriting for Epaphroditus consists of two vertical columns of symbols. The left column starts with a circle, followed by a square with a horizontal line, a square with a diagonal line, a square with a horizontal line, a square with a diagonal line, and a square with a horizontal line. The right column starts with a horizontal line, followed by a square with a diagonal line, a square with a horizontal line, a square with a diagonal line, and a square with a horizontal line.</p>
Epenetus	 <p>The SignWriting for Epenetus is a single vertical column of symbols. It starts with a square with a horizontal line, followed by a square with a diagonal line, a square with a horizontal line, a square with a diagonal line, a square with a horizontal line, a square with a diagonal line, a square with a horizontal line, a square with a diagonal line, a square with a horizontal line, and a square with a diagonal line.</p>
Ephah	 <p>The SignWriting for Ephah is a single vertical column of symbols. It starts with a square with a horizontal line, followed by a square with a diagonal line, a square with a horizontal line, a square with a diagonal line, and a square with a horizontal line.</p>
Epher	 <p>The SignWriting for Epher is a single vertical column of symbols. It starts with a square with a horizontal line, followed by a square with a diagonal line, a square with a horizontal line, a square with a diagonal line, a square with a horizontal line, and a square with a diagonal line.</p>



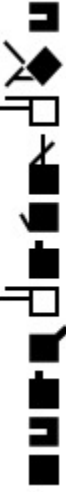

ASL Bible Dictionary

Spoken Word	SignWriting
Ephesians	
Ephesus	
Ephphatha	
Ephraim	



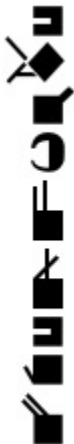

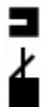

ASL Bible Dictionary

Spoken Word	SignWriting
Ephrath	
Ephrathah	
Ephrathites	
Ephron	



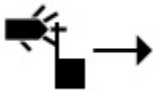



ASL Bible Dictionary

Spoken Word	SignWriting
Epicurean	
epilepsy	
equal	
Er	
Erastus	
Erech	

ASL Bible Dictionary

Spoken Word	SignWriting
Eri	
error	
error	
error	
Esau	
escape	
escape	
escape	
escapes	

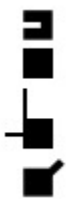
ASL Bible Dictionary

Spoken Word	SignWriting
Esek	
Eshban	
Eshcol	
Eshtaol	
Esli	
especially	



ASL Bible Dictionary

Spoken Word	SignWriting
establish	
established	
estate	
Esther	
Esther	
Etam	
etched	
eternal	

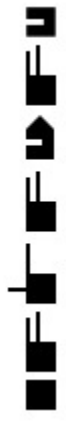

ASL Bible Dictionary

Spoken Word	SignWriting
eternal	<p>The SignWriting for 'eternal' consists of several components: a circle with two diagonal lines inside, a house-like shape, a circular arrow, two solid black circles with arrows pointing left and right, and two separate signs at the bottom, each consisting of a vertical line with a horizontal bar and a small square.</p>
Ethiopia	<p>The SignWriting for 'Ethiopia' is a vertical sequence of signs: a house-like shape, a diamond with a diagonal line, a circle, a square, and a house-like shape.</p>
ethnocentric	<p>The SignWriting for 'ethnocentric' consists of two vertical sequences of signs. The first sequence includes a circle, a house-like shape, a diamond with a diagonal line, and a square. The second sequence includes a circle, a house-like shape, a diamond with a diagonal line, a square, and another circle.</p>

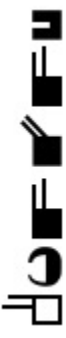



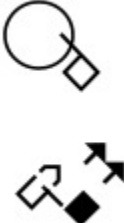

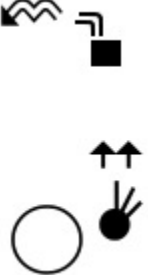
ASL Bible Dictionary

Spoken Word	SignWriting
Eubulus	
Eunice	
eunuch	
eunuch	

ASL Bible Dictionary

Spoken Word	SignWriting
Eutychus	 <p>The SignWriting for 'Eutychus' consists of a vertical sequence of symbols: a solid black square, a horizontal line, a square with a vertical line through its center, a circle, a square with a diagonal line from top-left to bottom-right, a solid black square, and another solid black square.</p>
evaluate	 <p>The SignWriting for 'evaluate' consists of two parts. The first part is a circle with a square attached to its right side, tilted upwards. The second part is a square with an arrow pointing up and to the right, and another square with an arrow pointing up and to the left.</p>
evaluate	 <p>The SignWriting for 'evaluate' consists of two parts. The first part is a square with an arrow pointing up and to the left, and another square with an arrow pointing up and to the right. The second part is a solid black square with an arrow pointing up and to the right.</p>
evangelism	 <p>The SignWriting for 'evangelism' consists of two parts. The first part is a wavy line with an arrow pointing up and to the right, and a square with an arrow pointing up and to the right. The second part is a circle with an arrow pointing up and to the right, and a solid black circle with an arrow pointing up and to the right.</p>

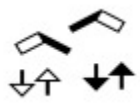
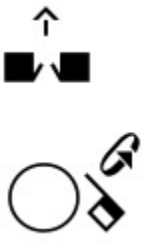

ASL Bible Dictionary

Spoken Word	SignWriting
evangelist	 A vertical sequence of signs: a square with an arrow pointing up, a square with an arrow pointing down, a square with an arrow pointing left, a square with an arrow pointing right, a square with an arrow pointing up, a square with an arrow pointing down, a square with an arrow pointing left, a square with an arrow pointing right, a square with an arrow pointing up, a square with an arrow pointing down, a square with an arrow pointing left, a square with an arrow pointing right, a square with an arrow pointing up, a square with an arrow pointing down, a square with an arrow pointing left, a square with an arrow pointing right, a square with an arrow pointing up, a square with an arrow pointing down, a square with an arrow pointing left, a square with an arrow pointing right.
Eve	 A circle with a square below it, and two asterisks (**).
even	 A circle with two diagonal lines inside, a square below it, and an arrow pointing up.
even	 A square with an arrow pointing down.
even-though	 A square with an arrow pointing down, a square with an arrow pointing up, a square with an arrow pointing down, a square with an arrow pointing up.
everlasting	 A square with an arrow pointing up, a square with an arrow pointing down, a square with an arrow pointing up, a square with an arrow pointing down, a circle with a square below it, a square with an arrow pointing down, a square with an arrow pointing up.
every	 A square with an arrow pointing down, a square with an arrow pointing up, a square with an arrow pointing down, a square with an arrow pointing up.

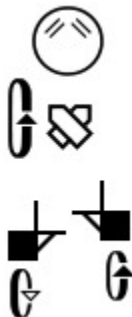

ASL Bible Dictionary

Spoken Word	SignWriting
every	
every	
every	
every thought captive	
every-day	
everyday	
everyone	
everyone	

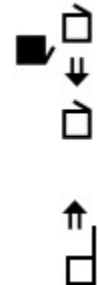
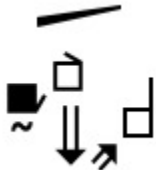
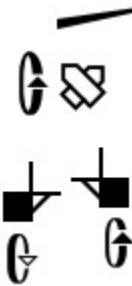
ASL Bible Dictionary

Spoken Word	SignWriting
everyone	 <p>The SignWriting for 'everyone' in the first variation consists of: a circle with two diagonal lines inside; a vertical oval with a horizontal line through its center; a diamond shape with a vertical line through its center; a square with a vertical line through its center and a horizontal line extending to the right; and a square with a vertical line through its center and a horizontal line extending to the left.</p>
everyone	 <p>The SignWriting for 'everyone' in the second variation consists of: a square with a vertical line through its center and a horizontal line extending to the right; a square with a vertical line through its center and a horizontal line extending to the left; a square with a vertical line through its center and a horizontal line extending to the right; a square with a vertical line through its center and a horizontal line extending to the left; and a square with a vertical line through its center and a horizontal line extending to the right.</p>
everyone	 <p>The SignWriting for 'everyone' in the third variation consists of: a square with a vertical line through its center and a horizontal line extending to the right; a square with a vertical line through its center and a horizontal line extending to the left; a square with a vertical line through its center and a horizontal line extending to the right; and a square with a vertical line through its center and a horizontal line extending to the left.</p>
everyone	 <p>The SignWriting for 'everyone' in the fourth variation consists of: a vertical line; a square with a vertical line through its center and a horizontal line extending to the right; a square with a vertical line through its center and a horizontal line extending to the left; a square with a vertical line through its center and a horizontal line extending to the right; and a square with a vertical line through its center and a horizontal line extending to the left.</p>
everyone	 <p>The SignWriting for 'everyone' in the fifth variation consists of: a vertical line; a vertical oval with a horizontal line through its center; a diamond shape with a vertical line through its center; a square with a vertical line through its center and a horizontal line extending to the right; and a square with a vertical line through its center and a horizontal line extending to the left.</p>

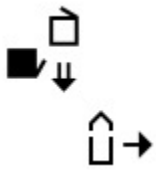
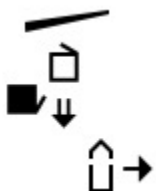
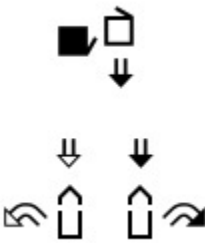
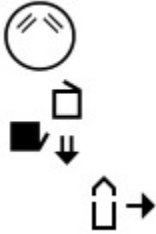



ASL Bible Dictionary

Spoken Word	SignWriting
everything	
everything	
everything	
everything	
everything	
evidence	



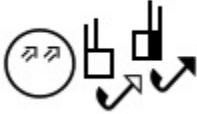
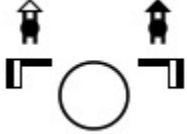
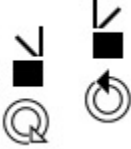

ASL Bible Dictionary

Spoken Word	SignWriting
evil	<p>The sign for 'evil' is represented by a circle above a vertical rectangle. A hand icon is positioned to the left of the vertical rectangle, with an arrow pointing towards it from the left.</p>
evils	<p>The sign for 'evils' is represented by a circle above a vertical rectangle. Two hand icons are positioned below the vertical rectangle, with arrows pointing towards it from both the left and right sides.</p>
ewes	<p>The sign for 'ewes' is represented by a circle above a vertical rectangle. A hand icon is positioned to the left of the vertical rectangle, with an arrow pointing towards it from the left. Below the vertical rectangle, there is a square with an arrow pointing towards it from the left.</p>
exact	<p>The sign for 'exact' is represented by a vertical rectangle with a circle to its right. A hand icon is positioned to the right of the circle, with an arrow pointing towards it from the right.</p>
exact	<p>The sign for 'exact' is represented by a vertical rectangle with a circle to its right. A hand icon is positioned to the right of the circle, with an arrow pointing towards it from the right.</p>
exact	<p>The sign for 'exact' is represented by a vertical rectangle with a circle to its right. A hand icon is positioned to the right of the circle, with an arrow pointing towards it from the right.</p>
exaggerate	<p>The sign for 'exaggerate' is represented by a circle above a vertical rectangle. A hand icon is positioned to the right of the vertical rectangle, with an arrow pointing towards it from the right. Below the vertical rectangle, there is a square with an arrow pointing towards it from the right.</p>
exalt	<p>The sign for 'exalt' is represented by a circle with two small squares inside it. Two hand icons are positioned above the circle, with arrows pointing towards it from both the left and right sides.</p>



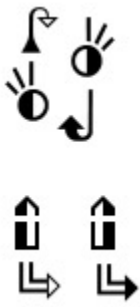

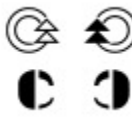
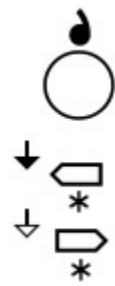

ASL Bible Dictionary

Spoken Word	SignWriting
exalt	
exalt	
examine	
example	
example	
example	



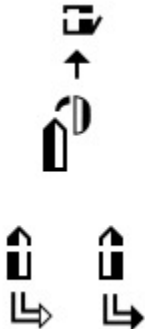



ASL Bible Dictionary

Spoken Word	SignWriting
exchange	
exchangers	
excited	
exclude	
excuses	
exert	
exhale	

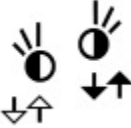
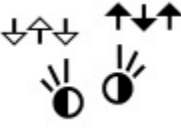





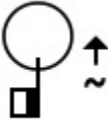

ASL Bible Dictionary

Spoken Word	SignWriting
expert	 <p>The signwriting for 'expert' in the first row consists of a vertical sequence of three symbols: a square with a right-pointing arrow, an upward-pointing arrow, and a hand with the index finger pointing right. Below this sequence are two separate symbols, each consisting of a vertical rectangle with an upward-pointing arrow above it and a downward-pointing arrow below it.</p>
expert	 <p>The signwriting for 'expert' in the second row consists of a vertical sequence of three symbols: a square with a right-pointing arrow, an upward-pointing arrow, and a hand with the index finger pointing right.</p>
experts	 <p>The signwriting for 'experts' in the third row consists of a vertical sequence of three symbols: a square with a right-pointing arrow, an upward-pointing arrow, and a hand with the index finger pointing right. Below this sequence are two separate symbols, each consisting of a vertical rectangle with an upward-pointing arrow above it and a rightward-pointing arrow below it.</p>
explain	 <p>The signwriting for 'explain' in the fourth row consists of two symbols side-by-side. The left symbol is a hand with the index finger pointing right, with an upward-pointing arrow above it and a downward-pointing arrow below it. The right symbol is a hand with the index finger pointing right, with a downward-pointing arrow below it and another downward-pointing arrow to its right.</p>
explain	 <p>The signwriting for 'explain' in the fifth row consists of two symbols side-by-side. The left symbol is a hand with the index finger pointing right, with an upward-pointing arrow above it and a downward-pointing arrow below it. The right symbol is a hand with the index finger pointing right, with a downward-pointing arrow below it and another downward-pointing arrow to its right.</p>
explain	 <p>The signwriting for 'explain' in the sixth row consists of two symbols side-by-side. The left symbol is a hand with the index finger pointing right, with an upward-pointing arrow above it and a downward-pointing arrow below it. The right symbol is a hand with the index finger pointing right, with a downward-pointing arrow below it and another downward-pointing arrow to its right.</p>



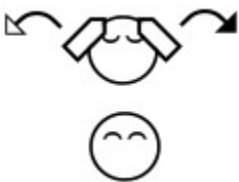



ASL Bible Dictionary

Spoken Word	SignWriting
explain	
explain	
explain	
explain-to-me	
exposure	
express	
expression	

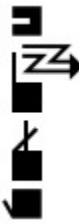

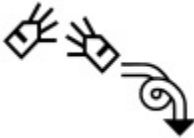

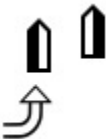
ASL Bible Dictionary

Spoken Word	SignWriting
extremely	
eye	
eye	
eyes	
eyes	
eyes	
Ezbon	
Ezer	



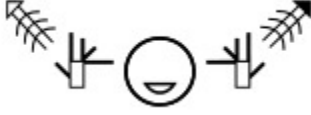

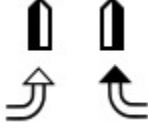
ASL Bible Dictionary

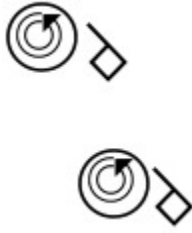
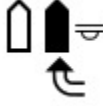
Spoken Word	SignWriting
Ezer	
Ezra	
F	
fabric	
fabric	
face	
face	



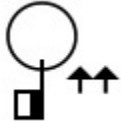
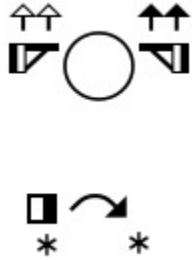

ASL Bible Dictionary

Spoken Word	SignWriting
face	
face	
face	
face	
face	
face-shine	
faces	
facing	



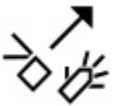
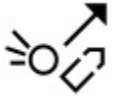
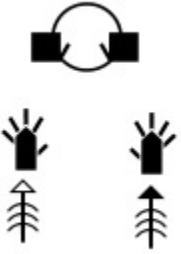

ASL Bible Dictionary

Spoken Word	SignWriting
facts	
facts	
faculty	
fade	
fade-away	
fail	



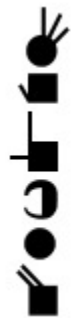

ASL Bible Dictionary

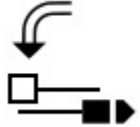
Spoken Word	SignWriting
fail	
fail	
faint	
Fair	
faith	
faith	
faith	

ASL Bible Dictionary

Spoken Word	SignWriting
Faithful	 <p>The SignWriting for 'Faithful' consists of a vertical sequence of seven symbols: a hand with fingers spread, a hand with fingers spread, a hand with fingers spread, a hand with fingers spread, a hand with fingers spread, a hand with fingers spread, and a hand with fingers spread.</p>
fake	 <p>The SignWriting for 'fake' consists of a hand with fingers spread, a hand with fingers spread, and a hand with fingers spread.</p>
Falcon	 <p>The SignWriting for 'Falcon' consists of a vertical sequence of seven symbols: a hand with fingers spread, a hand with fingers spread, a hand with fingers spread, a hand with fingers spread, a hand with fingers spread, a hand with fingers spread, and a hand with fingers spread.</p>
fall	 <p>The SignWriting for 'fall' consists of a hand with fingers spread, a hand with fingers spread, and a hand with fingers spread.</p>
fall	 <p>The SignWriting for 'fall' consists of a hand with fingers spread, a hand with fingers spread, and a hand with fingers spread.</p>
fall	 <p>The SignWriting for 'fall' consists of a hand with fingers spread, a hand with fingers spread, and a hand with fingers spread.</p>

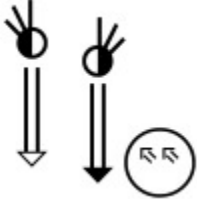
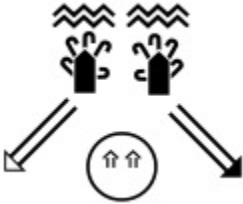
ASL Bible Dictionary

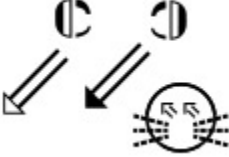
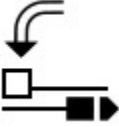
Spoken Word	SignWriting
fall	
fall	
fall	
fall	
fall	
fall	
fall	





ASL Bible Dictionary

Spoken Word	SignWriting
fall back	<p>The signwriting consists of a circle with two horizontal lines above it, representing a face with closed eyes. Below this are two hands, each with a square marker on the palm. The hands are positioned as if they are falling back.</p>
fall-at-Feet	<p>The signwriting shows a hand with a square marker on the palm, moving downwards towards a foot. A small arrow points to the right, indicating the direction of the movement.</p>
fall-back	<p>The signwriting features a hand with a square marker on the palm, moving downwards and then back. A small arrow points to the right, and a '#' symbol is located below the hand.</p>
fall-flat	<p>The signwriting shows a hand with a square marker on the palm, moving downwards and then flat. A small arrow points to the right, and a '#' symbol is located below the hand.</p>
fall-in	<p>The signwriting depicts a hand with a square marker on the palm, moving downwards and then in. A small arrow points to the right, and a '#' symbol is located below the hand.</p>
fall-in-love	<p>The signwriting consists of a circle with a vertical line extending downwards from its center. Below this are two hands, each with a square marker on the palm. The hands are positioned as if they are falling in. A small arrow points to the right, and a '*' symbol is located below the hands.</p>
fallen	<p>The signwriting shows a hand with a square marker on the palm, moving downwards and then fallen. A small arrow points to the right, and a '#' symbol is located below the hand.</p>





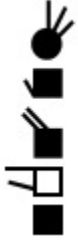
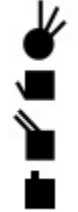

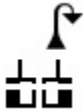
ASL Bible Dictionary

Spoken Word	SignWriting
falling-away	<p>The signwriting for 'falling-away' consists of four elements: a circle containing two small triangles pointing towards each other, a hand with fingers spread, a hand with fingers spread and a diagonal line extending from the wrist, and a hand with fingers spread.</p>
families	<p>The signwriting for 'families' consists of two groups of signs. The first group has two hands with fingers spread, each with a vertical line through the palm. The second group has two hands with fingers spread, each with a vertical line through the palm, positioned below the first group.</p>
family	<p>The signwriting for 'family' consists of two hands with fingers spread, each with a vertical line through the palm, positioned one above the other.</p>
famine	<p>The signwriting for 'famine' consists of three elements: a hand with fingers spread and a curved arrow pointing upwards, a hand with fingers spread and a circle above it with two asterisks to the right, and a hand with fingers spread and a circle above it with a hand pointing to the circle.</p>
famine	<p>The signwriting for 'famine' consists of a vertical sequence of five signs: a hand with fingers spread, a hand with fingers spread, a hand with fingers spread, a hand with fingers spread, and a hand with fingers spread.</p>

ASL Bible Dictionary

Spoken Word	SignWriting
famous	
fancy	
fang	
fangs	
Fant	
far	
far	
far	



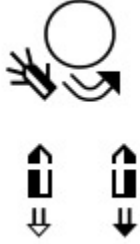



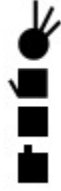

ASL Bible Dictionary

Spoken Word	SignWriting
far	
far	
far	
far	
far	
far-out	
farm	
farmer	





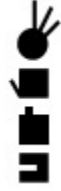

ASL Bible Dictionary

Spoken Word	SignWriting
farmers	<p>The signwriting for 'farmers' consists of three parts. The top part shows a hand with fingers spread, moving towards a circle, with a curved arrow indicating the path. Below this are two separate hand movements, each starting with a vertical line and ending with a horizontal line pointing to the right.</p>
fascinate	<p>The signwriting for 'fascinate' shows a hand with fingers spread moving towards a square, with a curved arrow. To the right, two hands with fingers spread are positioned above a circular path.</p>
fascinate	<p>The signwriting for 'fascinate' shows a hand with fingers spread moving towards a square, with a curved arrow. Below this, two hands with fingers spread are positioned above a circular path.</p>
fascination	<p>The signwriting for 'fascination' features a central circle containing the letters 'R R'. Above it are two squares, each with a horizontal line. Two hands with fingers spread are positioned on either side of the circle, with wavy lines below them. Arrows point from the hands towards the central circle.</p>
Fascination-1	<p>The signwriting for 'Fascination-1' is similar to 'fascination', but the arrows point from the hands towards the top squares instead of the central circle.</p>
fashion	<p>The signwriting for 'fashion' shows a hand with fingers spread moving towards a square, with a curved arrow. Below this are three vertical lines, each with a horizontal line at the bottom.</p>



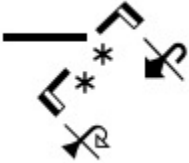





ASL Bible Dictionary

Spoken Word	SignWriting
fast	
fast	
faster	
fasting	
fat	
fate	
fate	
father	

ASL Bible Dictionary

Spoken Word	SignWriting
father	
Father	
fault	
favor	
favorite	
favorite	
favorite	

ASL Bible Dictionary

Spoken Word	SignWriting
favoured	
fear	
fear	
fear	
feather	
feather	
feathers	
feathers	





ASL Bible Dictionary

Spoken Word	SignWriting
feldshers	<p>The SignWriting for 'feldshers' consists of a vertical sequence of symbols: a hand with fingers spread, a horizontal line, a square, a horizontal line, a circle, a square, a square with a vertical line on the right, a horizontal line, a square, a square with a vertical line on the right, a square, a square with a vertical line on the right, and a square.</p>
Felix	<p>The SignWriting for 'Felix' consists of a vertical sequence of symbols: a hand with fingers spread, a horizontal line, a square, a horizontal line, a square, a square with a vertical line on the right, and a square.</p>
fell to ground	<p>The SignWriting for 'fell to ground' consists of a vertical sequence of symbols: a hand with fingers spread, a hand with fingers spread and a curved arrow pointing down, a hand with fingers spread and a curved arrow pointing down, a hand with fingers spread and a curved arrow pointing down, a hand with fingers spread and a curved arrow pointing down, and a hand with fingers spread and a curved arrow pointing down.</p>
fellow	<p>The SignWriting for 'fellow' consists of a vertical sequence of symbols: a hand with fingers spread, a horizontal line, a square, a horizontal line, a square, a circle, a square, a square with a vertical line on the right, and a square.</p>

ASL Bible Dictionary

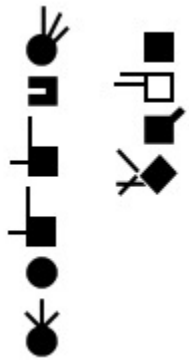
Spoken Word	SignWriting
Fellow	<p>The SignWriting for 'Fellow' consists of a vertical sequence of six symbols: a circle with three lines radiating from the top right, a square with a horizontal line extending from its top edge, another square with a horizontal line extending from its top edge, a third square with a horizontal line extending from its top edge, a solid black circle, and finally a circle with three lines radiating from the top right.</p>
fellow-servant	<p>The SignWriting for 'fellow-servant' consists of four rows of symbols. The first row has two identical symbols, each a square with a horizontal line extending from its top edge and two arrows pointing outwards from the top corners. The second row has two identical symbols, each a vertical rectangle with an upward-pointing arrow on the left side and a downward-pointing arrow on the right side. The third row has a single symbol: a square with a horizontal line extending from its top edge and two arrows pointing outwards from the top corners. The fourth row has a single symbol: a diamond shape with a horizontal line extending from its left side.</p>
fellow-worker	<p>The SignWriting for 'fellow-worker' consists of four rows of symbols. The first row has a single symbol: a vertical rectangle with a horizontal line extending from its top edge, a downward-pointing arrow on the left side, and an upward-pointing arrow on the right side. The second row has two identical symbols, each a vertical rectangle with an upward-pointing arrow on the left side and a downward-pointing arrow on the right side. The third row has a single symbol: a square with a horizontal line extending from its top edge and two arrows pointing outwards from the top corners. The fourth row has a single symbol: a diamond shape with a horizontal line extending from its left side and an asterisk symbol below it.</p>

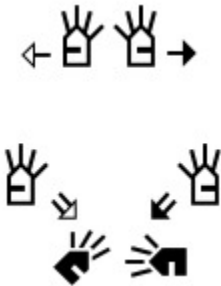

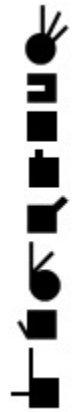

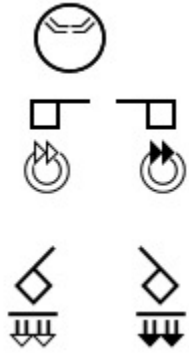

ASL Bible Dictionary

Spoken Word	SignWriting
fellowship	
fence	
fence-collapse	
fervent	
festival	
festival	

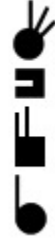



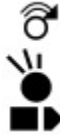

ASL Bible Dictionary

Spoken Word	SignWriting
Festus	 A vertical sequence of seven black shapes representing the sign for 'Festus'. From top to bottom: a circle with three lines radiating from the top right; a square with a vertical line on the left; a square with a vertical line on the left; a square with a vertical line on the left; a square with a horizontal line on the top; a square with a horizontal line on the top; and a square with a horizontal line on the top.
feud	 A sequence of seven signs for 'feud' arranged in three rows. Row 1: a circle with a horizontal line across the middle. Row 2: a square with a horizontal line on the top, and a square with a horizontal line on the top. Row 3: a circle with a horizontal line across the middle and a clockwise arrow, and a circle with a horizontal line across the middle and a counter-clockwise arrow. Row 4: a diamond with a horizontal line on the top, and a diamond with a horizontal line on the top. Row 5: a square with a horizontal line on the top, and a square with a horizontal line on the top.

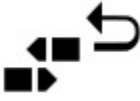
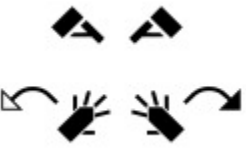
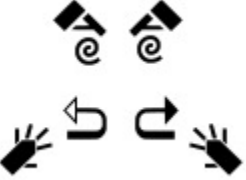
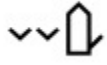
ASL Bible Dictionary

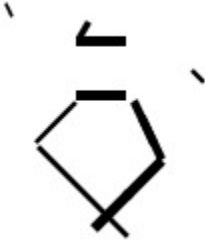
Spoken Word	SignWriting
feud	
fever	
few	
FH	
fiancee	
fibrosis	
field	







ASL Bible Dictionary

Spoken Word	SignWriting
field	
field	
fields	
fifteen	
fifth	
fifth	
fifth	
fifty	
fig	



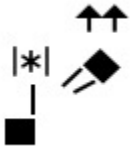
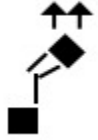

ASL Bible Dictionary

Spoken Word	SignWriting
fight	
figs	
figure	
file	
fill	
fill	
fill	
filth	
finally	



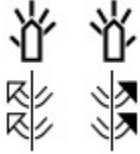
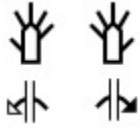
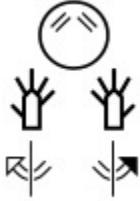

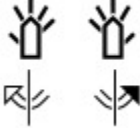

ASL Bible Dictionary

Spoken Word	SignWriting
fine	
fine	
fine	
finger	
finger	
fingers	
fingers	
finish	



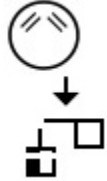

ASL Bible Dictionary

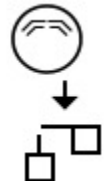
Spoken Word	SignWriting
finish	
finish	
finish	
finish	
finish	
finish	
fire	



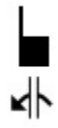
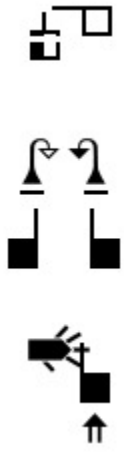
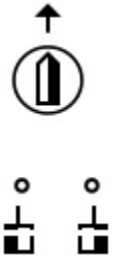



ASL Bible Dictionary

Spoken Word	SignWriting
fire	
fire	
firefighter	
firefighter	
first	
first	
first	
first	

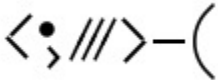

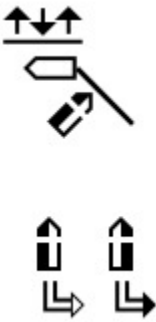



ASL Bible Dictionary

Spoken Word	SignWriting
first	
first-responders	
firsthand	
fish	
fish	
fish	

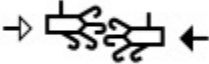
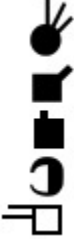



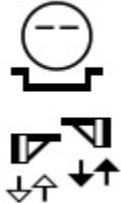

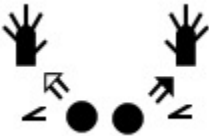
ASL Bible Dictionary

Spoken Word	SignWriting
Fish	
fish-symbol	
fisherman	
fishermen	
fishing	
fishing	
fists	

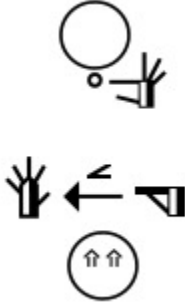
ASL Bible Dictionary

Spoken Word	SignWriting
fit	
Fitch	
five	
Five	
fix	
fix	
flag	
flash	
flash	



ASL Bible Dictionary

Spoken Word	SignWriting
flashes	 <p>The signwriting for 'flashes' (verb) consists of three parts: a circle with a dot inside and a hand with fingers spread to the right; a hand with fingers spread to the left and a hand with fingers spread to the right; and a circle containing two upward-pointing arrows.</p>
flashes	 <p>The signwriting for 'flashes' (noun) consists of three parts: a hand with fingers spread to the right above a wavy line; a circle with a dot inside and a hand with fingers spread to the right; and a hand with fingers spread to the right above an upward-pointing arrow.</p>
flat	 <p>The signwriting for 'flat' consists of two upward-pointing arrows with a horizontal line between them, and arrows pointing left and right from the ends of the line.</p>
flat-hand	 <p>The signwriting for 'flat-hand' is a single upward-pointing arrow.</p>
flatter	 <p>The signwriting for 'flatter' consists of two wavy lines above two hands with fingers spread to the right.</p>
flatter	 <p>The signwriting for 'flatter' (verb) consists of two parts: a hand with fingers spread to the right above a hand with fingers spread to the right, and a hand with fingers spread to the right above a hand with fingers spread to the right.</p>
flaunt	 <p>The signwriting for 'flaunt' consists of a curved arrow pointing left above a hand with fingers spread to the right.</p>



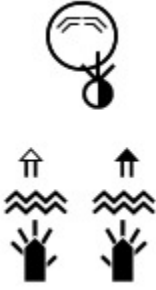

ASL Bible Dictionary

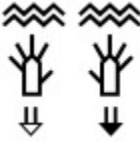
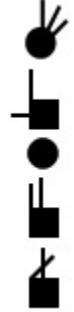
Spoken Word	SignWriting
flax	<p>The sign for 'flax' is written vertically. It starts with a hand sign (a circle with three lines radiating from the top) at the top, followed by a horizontal line, a square, and another horizontal line, ending with a hand sign at the bottom.</p>
fled	<p>The sign for 'fled' is written vertically. It starts with a hand sign (a circle with three lines radiating from the top) at the top, followed by a horizontal line, a square, and another horizontal line, ending with a hand sign at the bottom. There are also two small arrows pointing up and left from the square.</p>
flock	<p>The sign for 'flock' is written horizontally. It consists of two circles, each with a downward-pointing arrow below it.</p>
flock	<p>The sign for 'flock' is written vertically. It starts with a hand sign (a circle with three lines radiating from the top) at the top, followed by a horizontal line, a square, a circle, and another horizontal line, ending with a hand sign at the bottom.</p>
flock-to	<p>The sign for 'flock-to' is written horizontally. It consists of two hand signs (a circle with three lines radiating from the top) facing each other, with a zigzag line between them and two arrows pointing towards each other.</p>
flocks	<p>The sign for 'flocks' is written horizontally. It consists of a circle with three lines radiating from the top at the top center, two hand signs (a circle with three lines radiating from the top) on the left and right, and a circle with three lines radiating from the top at the bottom center. There are also two arrows pointing towards each other.</p>
flog	<p>The sign for 'flog' is written horizontally. It consists of a hand sign (a circle with three lines radiating from the top) on the left, a zigzag line in the middle, and a square on the right.</p>
flog	<p>The sign for 'flog' is written horizontally. It consists of a hand sign (a circle with three lines radiating from the top) on the left, a zigzag line in the middle, and a square on the right.</p>



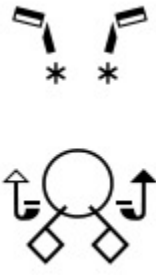

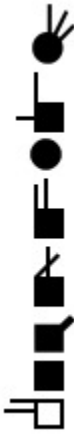
ASL Bible Dictionary

Spoken Word	SignWriting
flood	
flood	
Florida	
flour	
flour	



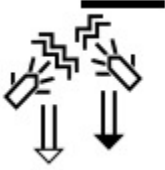



ASL Bible Dictionary

Spoken Word	SignWriting
flourish	
flourish	
flourishes	
flourishes	
flow	

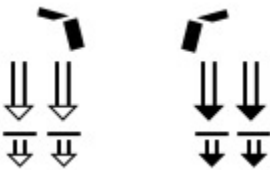
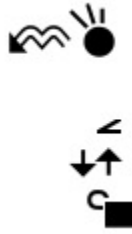



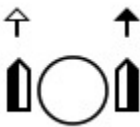
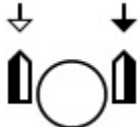



ASL Bible Dictionary

Spoken Word	SignWriting
flowed	
flower	
flower-fades	
flowers	
flute	

ASL Bible Dictionary

Spoken Word	SignWriting
fly	
fly swatter	
flying	
foam	
focus	
focus	
focus	
focus	

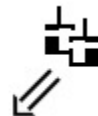
ASL Bible Dictionary

Spoken Word	SignWriting
focus	
foe	
folded	
follow	
follow	
follow	
follow	
follow	
follow	







ASL Bible Dictionary

Spoken Word	SignWriting
follow	<p>The signwriting for 'follow' consists of a circle with two upward-pointing arrows above it, representing the word 'follow'. Below this is a square with a vertical line through its center and a small square on top, with an arrow pointing up and to the right, representing the word 'follow'.</p>
follower	<p>The signwriting for 'follower' consists of a square with a vertical line through its center and a small square on top, with an arrow pointing up and to the right, representing the word 'follower'. Below this are two vertical rectangles, each with a downward-pointing arrow below it, representing the word 'follower'.</p>
followers	<p>The signwriting for 'followers' consists of a square with a vertical line through its center and a small square on top, with an arrow pointing up and to the right, representing the word 'followers'. Below this are two vertical rectangles, each with an upward-pointing arrow above it and a downward-pointing arrow below it, representing the word 'followers'.</p>
folly	<p>The signwriting for 'folly' consists of a vertical line with a solid black circle at the top, representing the word 'folly'. Below this is a square with a vertical line through its center and a small square on top, with an arrow pointing up and to the right, representing the word 'folly'.</p>
food	<p>The signwriting for 'food' consists of a circle with a small square inside it, representing the word 'food'.</p>
food	<p>The signwriting for 'food' consists of a circle with a small square inside it, representing the word 'food'.</p>
fool	<p>The signwriting for 'fool' consists of a square with a vertical line through its center and a small square on top, with an arrow pointing up and to the right, representing the word 'fool'.</p>

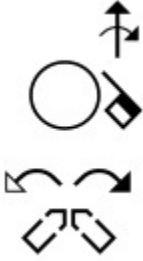





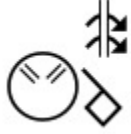

ASL Bible Dictionary

Spoken Word	SignWriting
fool	<p>The sign for 'fool' is composed of two parts. The first part is a circle with two hands positioned above it, palms facing each other, with fingers pointing towards the center of the circle. The second part consists of two hands, palms facing each other, with fingers pointing downwards.</p>
foolish	<p>The sign for 'foolish' is a single gesture consisting of a circle with two hands positioned above it, palms facing each other, with fingers pointing towards the center of the circle.</p>
fools	<p>The sign for 'fools' is a single gesture consisting of a circle with two hands positioned above it, palms facing each other, with fingers pointing towards the center of the circle.</p>
foot	<p>The sign for 'foot' is a vertical sequence of four elements: a hand with fingers pointing upwards, a solid black circle, another solid black circle, and a solid black square.</p>
football	<p>The sign for 'football' is a sequence of three elements: a hand with fingers pointing to the right, a hand with fingers pointing to the left, and a hand with fingers pointing to the right.</p>
for	<p>The sign for 'for' is a sequence of two elements: a circle and a hand with fingers pointing to the right.</p>
for	<p>The sign for 'for' is a sequence of three elements: a circle, a hand with fingers pointing to the right, and a hand with fingers pointing to the right.</p>
for	<p>The sign for 'for' is a sequence of three elements: a circle, a hand with fingers pointing to the right, and a hand with fingers pointing to the right.</p>



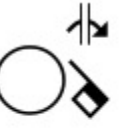



ASL Bible Dictionary

Spoken Word	SignWriting
for-all	
for-all	
for-for	
for-for	
for-for	
for-for	
for-for	

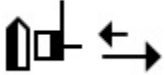
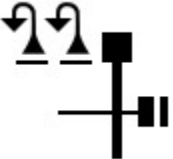
ASL Bible Dictionary

Spoken Word	SignWriting
for-for	
for-for	
for-for	
for-for	
for-r	
for-this	 
for-you	 







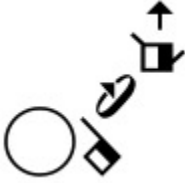
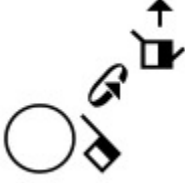

ASL Bible Dictionary

Spoken Word	SignWriting
forbid	
force	
force	
force	
ford	
forehead	
forehead	
foreign	

ASL Bible Dictionary

Spoken Word	SignWriting
foreigner	<p>The signwriting for 'foreigner' consists of a hand icon with the index finger pointing up and the thumb pointing right, with a counter-clockwise rotation arrow. Below this are two vertical double-headed arrows, one on the left and one on the right.</p>
foreigners	<p>The signwriting for 'foreigners' consists of a hand icon with the index finger pointing up and the thumb pointing right, with a counter-clockwise rotation arrow. Below this are two vertical double-headed arrows, one on the left and one on the right, with a rightward-pointing arrow at the bottom of each.</p>
foreman	<p>The signwriting for 'foreman' is a vertical sequence of five hand icons. From top to bottom: 1. Index finger pointing up, thumb pointing right, with a counter-clockwise rotation arrow. 2. Index finger pointing up, thumb pointing right. 3. Index finger pointing up, thumb pointing right. 4. Index finger pointing up, thumb pointing right. 5. Index finger pointing up, thumb pointing right.</p>
foresail	<p>The signwriting for 'foresail' consists of a square frame. At the top are two circles with horizontal double-headed arrows extending from them. On the left and right sides are vertical lines with squares at their ends. At the bottom is a hand icon with the index finger pointing up and the thumb pointing right, with a counter-clockwise rotation arrow.</p>

ASL Bible Dictionary

Spoken Word	SignWriting
forever	
forever	
forget	
forgive	
forgive	
forgive	
forgive	
forgive-all	
forgive-you	
forgot	

ASL Bible Dictionary

Spoken Word	SignWriting
fork	<p>The signwriting for 'fork' consists of a vertical sequence of four symbols: a hand with fingers spread, a solid black circle, a hand with fingers spread, and a solid black square.</p>
formal	<p>The signwriting for 'formal' consists of two symbols: a hand with fingers spread and a solid black square, with two upward-pointing arrows above the hand.</p>
forsake	<p>The signwriting for 'forsake' consists of four symbols arranged in a diamond pattern: a hand with fingers spread, a solid black square, a hand with fingers spread, and a solid black square.</p>
forsake	<p>The signwriting for 'forsake' consists of four symbols arranged in a diamond pattern: a hand with fingers spread, a solid black square, a hand with fingers spread, and a solid black square.</p>
fort	<p>The signwriting for 'fort' consists of a vertical sequence of four symbols: a hand with fingers spread, a solid black circle, a hand with fingers spread, and a solid black square.</p>
fortress	<p>The signwriting for 'fortress' consists of four symbols arranged in a 2x2 grid: a hand with fingers spread, a solid black square, a hand with fingers spread, and a solid black square.</p>

ASL Bible Dictionary

Spoken Word	SignWriting
fortress	<p>The SignWriting for 'fortress' consists of four vertical elements. From top to bottom: 1) A diamond shape with a small 'F' inside, flanked by two smaller diamonds. 2) A diamond shape with a small 'F' inside, flanked by two smaller diamonds, with a curved arrow pointing from the top-right diamond to the top-left diamond. 3) A diamond shape with a small 'F' inside, flanked by two smaller diamonds, with a curved arrow pointing from the top-left diamond to the top-right diamond. 4) A diamond shape with a small 'F' inside, flanked by two smaller diamonds, with a small upward-pointing arrow above it.</p>
fortresses	<p>The SignWriting for 'fortresses' consists of two rows of symbols. The top row has two squares, each with a small upward-pointing arrow above it. The bottom row has four vertical elements: 1) A square with a small upward-pointing arrow above it, and a vertical line extending upwards from the top of the square. 2) A square with a small upward-pointing arrow above it, and a vertical line extending upwards from the top of the square. 3) A square with a small upward-pointing arrow above it, and a vertical line extending upwards from the top of the square. 4) A square with a small upward-pointing arrow above it, and a vertical line extending upwards from the top of the square.</p>
Fortunatus	<p>The SignWriting for 'Fortunatus' is a vertical sequence of symbols. From top to bottom: 1) A circle with three lines radiating from the top. 2) A solid black circle. 3) A square with a small 'F' inside. 4) A square with a small 'F' inside. 5) A square with a small 'F' inside. 6) A square with a small 'F' inside. 7) A square with a small 'F' inside. 8) A square with a small 'F' inside. 9) A square with a small 'F' inside. 10) A square with a small 'F' inside. 11) A square with a small 'F' inside. 12) A square with a small 'F' inside. 13) A square with a small 'F' inside. 14) A square with a small 'F' inside. 15) A square with a small 'F' inside. 16) A square with a small 'F' inside. 17) A square with a small 'F' inside. 18) A square with a small 'F' inside. 19) A square with a small 'F' inside. 20) A square with a small 'F' inside. 21) A square with a small 'F' inside. 22) A square with a small 'F' inside. 23) A square with a small 'F' inside. 24) A square with a small 'F' inside. 25) A square with a small 'F' inside. 26) A square with a small 'F' inside. 27) A square with a small 'F' inside. 28) A square with a small 'F' inside. 29) A square with a small 'F' inside. 30) A square with a small 'F' inside. 31) A square with a small 'F' inside. 32) A square with a small 'F' inside. 33) A square with a small 'F' inside. 34) A square with a small 'F' inside. 35) A square with a small 'F' inside. 36) A square with a small 'F' inside. 37) A square with a small 'F' inside. 38) A square with a small 'F' inside. 39) A square with a small 'F' inside. 40) A square with a small 'F' inside. 41) A square with a small 'F' inside. 42) A square with a small 'F' inside. 43) A square with a small 'F' inside. 44) A square with a small 'F' inside. 45) A square with a small 'F' inside. 46) A square with a small 'F' inside. 47) A square with a small 'F' inside. 48) A square with a small 'F' inside. 49) A square with a small 'F' inside. 50) A square with a small 'F' inside. 51) A square with a small 'F' inside. 52) A square with a small 'F' inside. 53) A square with a small 'F' inside. 54) A square with a small 'F' inside. 55) A square with a small 'F' inside. 56) A square with a small 'F' inside. 57) A square with a small 'F' inside. 58) A square with a small 'F' inside. 59) A square with a small 'F' inside. 60) A square with a small 'F' inside. 61) A square with a small 'F' inside. 62) A square with a small 'F' inside. 63) A square with a small 'F' inside. 64) A square with a small 'F' inside. 65) A square with a small 'F' inside. 66) A square with a small 'F' inside. 67) A square with a small 'F' inside. 68) A square with a small 'F' inside. 69) A square with a small 'F' inside. 70) A square with a small 'F' inside. 71) A square with a small 'F' inside. 72) A square with a small 'F' inside. 73) A square with a small 'F' inside. 74) A square with a small 'F' inside. 75) A square with a small 'F' inside. 76) A square with a small 'F' inside. 77) A square with a small 'F' inside. 78) A square with a small 'F' inside. 79) A square with a small 'F' inside. 80) A square with a small 'F' inside. 81) A square with a small 'F' inside. 82) A square with a small 'F' inside. 83) A square with a small 'F' inside. 84) A square with a small 'F' inside. 85) A square with a small 'F' inside. 86) A square with a small 'F' inside. 87) A square with a small 'F' inside. 88) A square with a small 'F' inside. 89) A square with a small 'F' inside. 90) A square with a small 'F' inside. 91) A square with a small 'F' inside. 92) A square with a small 'F' inside. 93) A square with a small 'F' inside. 94) A square with a small 'F' inside. 95) A square with a small 'F' inside. 96) A square with a small 'F' inside. 97) A square with a small 'F' inside. 98) A square with a small 'F' inside. 99) A square with a small 'F' inside. 100) A square with a small 'F' inside.</p>



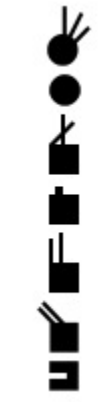
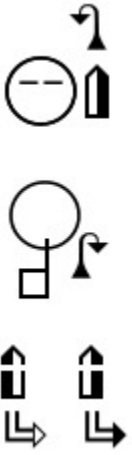
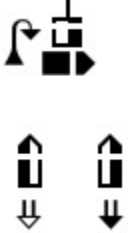
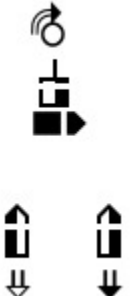



ASL Bible Dictionary

Spoken Word	SignWriting
Fortune	 <p>The SignWriting for 'Fortune' consists of a vertical sequence of symbols: a hand with fingers spread, a solid black circle, a hand with fingers spread, a solid black square, a hand with fingers spread, a solid black square, a hand with fingers spread, a solid black square, and a hand with fingers spread.</p>
fortune-tellers	 <p>The SignWriting for 'fortune-tellers' consists of three parts: a circle with a horizontal line through it and a hand with fingers spread, a circle with a vertical line through it and a hand with fingers spread, and two hands with fingers spread.</p>
founder	 <p>The SignWriting for 'founder' consists of a hand with fingers spread, a solid black square, and two hands with fingers spread.</p>
founder	 <p>The SignWriting for 'founder' consists of a hand with fingers spread, a solid black square, and two hands with fingers spread.</p>

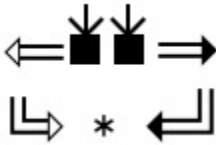

ASL Bible Dictionary

Spoken Word	SignWriting
founder	<p>The signwriting for 'founder' consists of two parts. The first part shows a hand with fingers curled, moving from the right side towards the left. The second part shows a hand with fingers spread, moving from the top towards the bottom.</p>
Fountain	<p>The signwriting for 'Fountain' is a vertical sequence of eight hand positions. It starts with a hand showing the palm side with fingers spread, followed by a hand with fingers curled, then a hand with fingers spread, then a hand with fingers curled, then a hand with fingers spread, then a hand with fingers curled, then a hand with fingers spread, and finally a hand with fingers curled.</p>
fountain	<p>The signwriting for 'fountain' starts with a hand showing the palm side with fingers spread, followed by a hand with fingers curled, then a hand with fingers spread, then a hand with fingers curled, then a hand with fingers spread, and finally a hand with fingers curled.</p>
fountain	<p>The signwriting for 'fountain' is a vertical sequence of eight hand positions, identical to the one above.</p>
Four	<p>The signwriting for 'Four' is a hand with fingers spread, showing the palm side.</p>



ASL Bible Dictionary

Spoken Word	SignWriting
fourth	
fowl	
Fowler	
foxes	
foxes	
frame	
France	

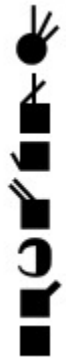



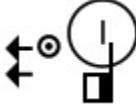

ASL Bible Dictionary

Spoken Word	SignWriting
France	 The SignWriting for 'France' consists of a vertical sequence of seven symbols: a hand with fingers spread, a hand with index and middle fingers extended, a hand with index and middle fingers extended, a hand with index and middle fingers extended, a hand with index and middle fingers extended, a hand with index and middle fingers extended, and a hand with index and middle fingers extended.
franchises	 The SignWriting for 'franchises' consists of a vertical sequence of ten symbols: a hand with fingers spread, a hand with index and middle fingers extended, a hand with index and middle fingers extended, a hand with index and middle fingers extended, a hand with index and middle fingers extended, a hand with index and middle fingers extended, a hand with index and middle fingers extended, a hand with index and middle fingers extended, a hand with index and middle fingers extended, and a hand with index and middle fingers extended.
Francis	 The SignWriting for 'Francis' consists of a vertical sequence of seven symbols: a hand with fingers spread, a hand with index and middle fingers extended, a hand with index and middle fingers extended, a hand with index and middle fingers extended, a hand with index and middle fingers extended, a hand with index and middle fingers extended, and a hand with index and middle fingers extended.

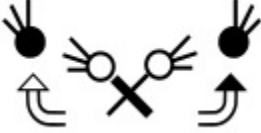





ASL Bible Dictionary

Spoken Word	SignWriting
Francisco	
Frank	
frankincense	
fraud	

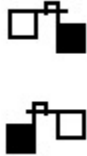
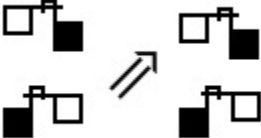
ASL Bible Dictionary

Spoken Word	SignWriting
Fray	
free	
Fremont	
frequent	
freshman	
fret	
Friday	







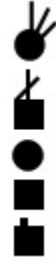

ASL Bible Dictionary

Spoken Word	SignWriting
friend	
friends	
fringe	
fringe	
frog	
frogs	
from	

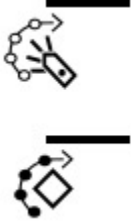



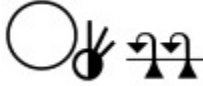



ASL Bible Dictionary

Spoken Word	SignWriting
from	<p>The SignWriting for 'from' consists of four vertical strokes: a hand with fingers spread, a hand with fingers spread and palm facing right, a solid black circle, and a hand with fingers spread and palm facing right.</p>
from-now-on	<p>The SignWriting for 'from-now-on' consists of two parts: a hand with fingers spread and palm facing right, and an upward-pointing arrow.</p>
from-now-on	<p>The SignWriting for 'from-now-on' consists of three parts: a circle with three diagonal lines inside, a hand with fingers spread and palm facing right, and an upward-pointing arrow.</p>
front	<p>The SignWriting for 'front' consists of a hand with fingers spread and palm facing right, and a circle with two horizontal lines inside and a downward-pointing arrow.</p>
front-page	<p>The SignWriting for 'front-page' consists of two parts: a hand with fingers spread and palm facing right, and a hand with fingers spread and palm facing right with a curved arrow pointing upwards and to the left.</p>
frontier	<p>The SignWriting for 'frontier' consists of seven vertical strokes: a hand with fingers spread, a hand with fingers spread and palm facing right, a solid black circle, a hand with fingers spread and palm facing right, a hand with fingers spread and palm facing right, a hand with fingers spread and palm facing right, and a hand with fingers spread and palm facing right.</p>





ASL Bible Dictionary

Spoken Word	SignWriting
Frost	
Frost	
Frost-test	
frown	
frozen	
fruit	
fruitful	
frustrate	
frustrate	



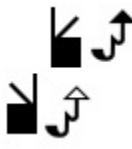

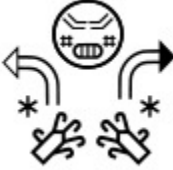

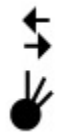
ASL Bible Dictionary

Spoken Word	SignWriting
FSL	
ft	
full	
full	
full	
full	
fullness	
fun	





ASL Bible Dictionary

Spoken Word	SignWriting
funeral	
funny	
furious	
furnace	
furnace	
furniture	



ASL Bible Dictionary

Spoken Word	SignWriting
future	
future	
future	
fuzzy	
fyi	
G	
Gabbai	



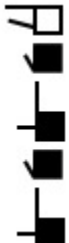
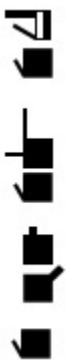

ASL Bible Dictionary

Spoken Word	SignWriting
Gabbatha	
Gabriel	
Gad	
Gadarenes	
Gaham	

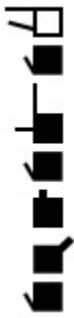

ASL Bible Dictionary

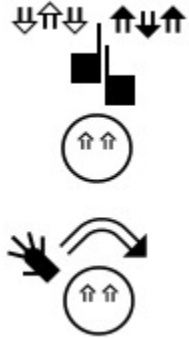
Spoken Word	SignWriting
Gahar	
gain	
Gaius	
Galal	
Galatia	



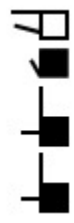
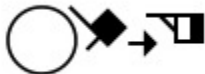

ASL Bible Dictionary

Spoken Word	SignWriting
Galatia	
Galatians	
Galatians	
galaxy	
Galeed	

ASL Bible Dictionary

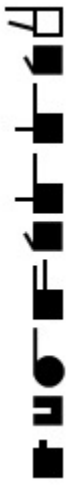
Spoken Word	SignWriting
Galilean	
Galilee	
gall	
Gallaudet	









ASL Bible Dictionary

Spoken Word	SignWriting
Gallaudet	
Gallio	
gallon	
gallop	
Gamaliel	

ASL Bible Dictionary

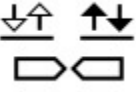
Spoken Word	SignWriting
gamble	<p>The signwriting for 'gamble' consists of a circle with a horizontal line through it, positioned above a hand icon with fingers spread. To the right of the hand is a jagged zigzag line, and below that is a small square icon.</p>
game	<p>The signwriting for 'game' features a hand icon with fingers spread on the left, followed by two small square icons, and a hand icon with fingers spread on the right.</p>
gang	<p>The signwriting for 'gang' includes a vertical line at the top, a hand icon with fingers spread below it, two circular symbols with dots inside, and a hand icon with fingers spread at the bottom.</p>
garbage	<p>The signwriting for 'garbage' is composed of two parts. The top part shows a hand icon with fingers spread, a vertical line, and two asterisks. The bottom part shows a hand icon with fingers spread and a square icon.</p>
garden	<p>The signwriting for 'garden' features a hand icon with fingers spread at the top, followed by a hand icon with fingers spread, a vertical line, and a hand icon with fingers spread at the bottom.</p>
garden	<p>The signwriting for 'garden' is composed of two parts. The top part shows a hand icon with fingers spread, a hand icon with fingers spread, a vertical line, and a hand icon with fingers spread. The bottom part shows a curved arrow pointing left and a hand icon with fingers spread.</p>





ASL Bible Dictionary

Spoken Word	SignWriting
Garrett	
Gary	
gas	
Gatam	
gate	
gate	
gate	
gate	
gate	



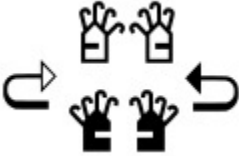
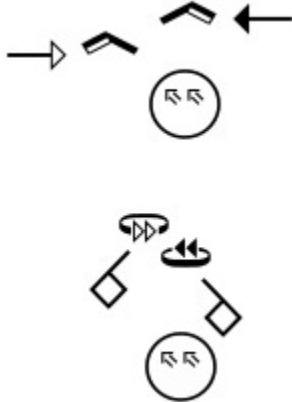



ASL Bible Dictionary

Spoken Word	SignWriting
gate-go-thru	<p>The signwriting consists of a black square on the left, a vertical line extending upwards from its top, and a curved arrow starting from the top of the line and pointing to the right. To the right of the arrow is a stylized pen icon with a small number '2' below it.</p>
gatekeeper	<p>The signwriting is composed of three distinct parts. The top part shows two horizontal ovals, with a curved arrow starting from the right side of the second oval and pointing upwards and to the right, ending at a pen icon. The middle part shows a pen icon with a diagonal line through it, positioned above a square with a diagonal line through it, which is above a stylized ear icon. The bottom part shows two vertical pen icons, each with a downward-pointing arrow below it.</p>
gatekeeper	<p>The signwriting is identical to the previous entry, showing the sequence of signs: two ovals with an arrow to a pen icon, a pen with a diagonal line over a square with a diagonal line over an ear icon, and two vertical pen icons with downward arrows.</p>
gates	<p>The signwriting consists of two rows of signs. The top row shows two pen icons with curved arrows pointing to the right, positioned above two horizontal ovals. The bottom row shows two pen icons with curved arrows pointing to the right, positioned above two horizontal ovals.</p>
Gath	<p>The signwriting consists of a vertical sequence of four signs: a square with a diagonal line through it, a solid black square, another square with a diagonal line through it, and a square with a diagonal line through it.</p>
gather	<p>The signwriting consists of a stylized number '3' on the left, followed by a pen icon with a curved arrow pointing to the right, and another pen icon on the right.</p>







ASL Bible Dictionary

Spoken Word	SignWriting
gather	
gather	
Gatorade	
gatorade	
gave	
gay	







ASL Bible Dictionary

Spoken Word	SignWriting
Gaza	
gazelle	
Gazzam	
gear	
Geba	
gem	

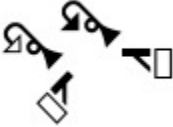
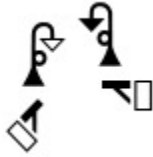

ASL Bible Dictionary

Spoken Word	SignWriting
gem	
gem	
gems	
gemstones	
geneology	
general	
General	



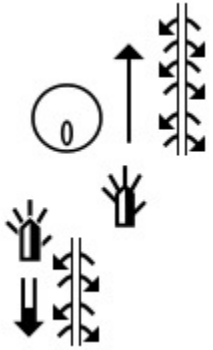

ASL Bible Dictionary

Spoken Word	SignWriting
generals	
generals	
generation	
generations	
generous	
generous	
Genesis	





ASL Bible Dictionary

Spoken Word	SignWriting
Genesis	
Genesis 01_01-13a	
Genesis 06:5	
Genesis 1	
Genesis 19:14	
Genesis 2	
Genesis 2	
Genesis 25:20	
genius	



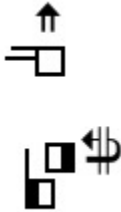

ASL Bible Dictionary

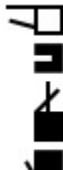
Spoken Word	SignWriting
Gennesaret	 <p>The signwriting for 'Gennesaret' is a vertical sequence of symbols. It begins with a hand sign (open palm, fingers together), followed by a series of horizontal lines and curves representing the syllables 'ne', 'nes', 'a', 're', and 't'.</p>
Gentiles	 <p>The signwriting for 'Gentiles' starts with a circle, followed by a hand sign (open palm, fingers together), and then a series of symbols representing the syllables 'en', 'til', 'es'.</p>
Gentiles	 <p>This entry is identical to the previous one, showing the signwriting for 'Gentiles'.</p>
gentle	 <p>The signwriting for 'gentle' consists of two hand signs: one with the index finger pointing up and the thumb pointing down, and another with the index finger pointing down and the thumb pointing up.</p>
gentle	 <p>This entry is identical to the previous one, showing the signwriting for 'gentle'.</p>





ASL Bible Dictionary

Spoken Word	SignWriting
gentleness	
gentry	
geometry	
George	
Georgetown	
Gera	



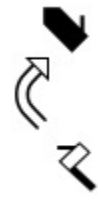

ASL Bible Dictionary

Spoken Word	SignWriting
Gerar	
Gerasenes	
Gerizim	
German	
Gershom	



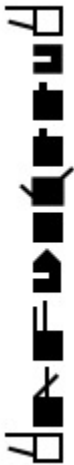

ASL Bible Dictionary

Spoken Word	SignWriting
get	
get-away	
get-up	
Gether	
Gethsemane	



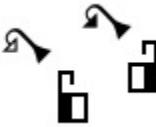

ASL Bible Dictionary

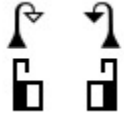
Spoken Word	SignWriting
Gettysburg	
ghost	
giant	
Gibbar	
Gibeah	

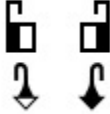
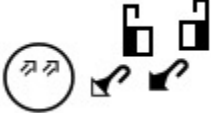

ASL Bible Dictionary

Spoken Word	SignWriting
Gibeon	
Giddel	
Gideon	
gift	
gift	
gift	

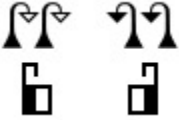
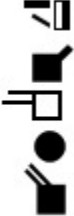
ASL Bible Dictionary

Spoken Word	SignWriting
gift	
gift	
gifts	
gifts	
gifts	
gifts	
Gihon	

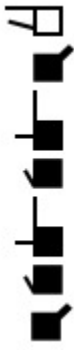
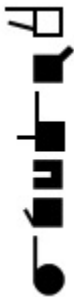



ASL Bible Dictionary

Spoken Word	SignWriting
<p style="text-align: center;">Gilalai</p>	
<p style="text-align: center;">Gilead</p>	
<p style="text-align: center;">Gilgal</p>	
<p style="text-align: center;">Ginnethon</p>	



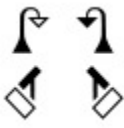
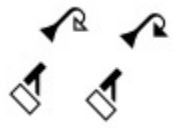



ASL Bible Dictionary

Spoken Word	SignWriting
gird-waist	<p>The signwriting for 'gird-waist' consists of a vertical line at the top, followed by two 'e' characters with arrows pointing outwards, and two 'u' characters with arrows pointing inwards.</p>
Girgashites	<p>The signwriting for 'Girgashites' is a vertical sequence of signs: a 'P' with a rightward arrow, a 'G' with a rightward arrow, a 'S' with a rightward arrow, a 'H' with a rightward arrow, a 'T' with a rightward arrow, and a 'S' with a rightward arrow.</p>
Girgasite	<p>The signwriting for 'Girgasite' is a vertical sequence of signs: a 'P' with a rightward arrow, a 'G' with a rightward arrow, a 'S' with a rightward arrow, a 'A' with a rightward arrow, and a 'T' with a rightward arrow.</p>
girl	<p>The signwriting for 'girl' consists of a circle with a rightward arrow, followed by a 'G' with a rightward arrow, and a 'L' with a rightward arrow.</p>
Gishpa	<p>The signwriting for 'Gishpa' is a vertical sequence of signs: a 'P' with a rightward arrow, a 'G' with a rightward arrow, a 'S' with a rightward arrow, a 'H' with a rightward arrow, and a 'P' with a rightward arrow.</p>

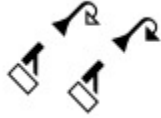

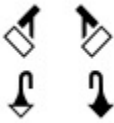

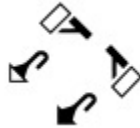
ASL Bible Dictionary

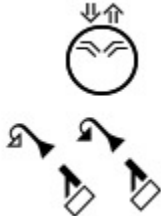
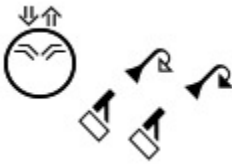
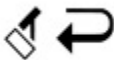
Spoken Word	SignWriting
Gittaim	
give	
give	
give	
give	
give	



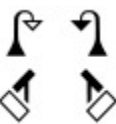

ASL Bible Dictionary

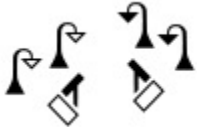
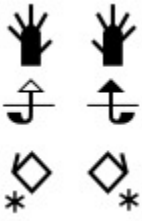
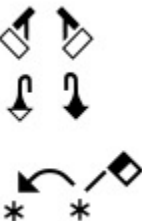
Spoken Word	SignWriting
give	
give	
give	
give	
give	
give	
give	
give	
give	
give	

ASL Bible Dictionary

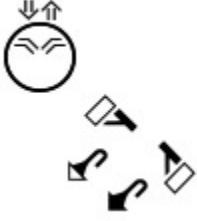
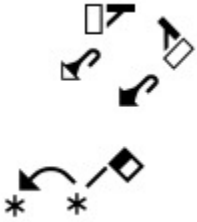
Spoken Word	SignWriting
give	
give	
give	
give	
give-birth	
give-give	
give-up	
give-us	

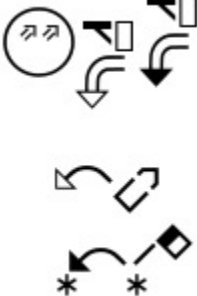
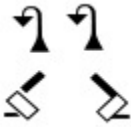



ASL Bible Dictionary

Spoken Word	SignWriting
give-us	
give-us	
give-you-all	
given-us	
giver	
gives	
gives	



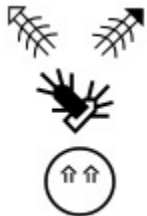

ASL Bible Dictionary

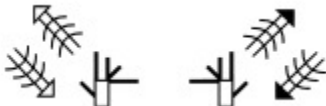
Spoken Word	SignWriting
gives-us	<p>The signwriting for 'gives-us' consists of a circle with two arrows pointing right, followed by a hand moving from a high position to a low position, and another hand moving from a high position to a low position. Below this, there are two curved arrows pointing right, one above the other, and two asterisks at the bottom.</p>
giving	<p>The signwriting for 'giving' consists of a circle with two arrows pointing right, followed by a hand moving from a high position to a low position, and another hand moving from a high position to a low position.</p>
giving	<p>The signwriting for 'giving' consists of a hand moving from a high position to a low position, and another hand moving from a high position to a low position.</p>
glad	<p>The signwriting for 'glad' consists of a circle with a smile, followed by two hands moving from a high position to a low position, and two asterisks at the bottom.</p>
gloat	<p>The signwriting for 'gloat' consists of a hand moving from a high position to a low position, followed by a hand moving from a high position to a low position, and a hand moving from a high position to a low position.</p>
gloom	<p>The signwriting for 'gloom' consists of a circle with a sad face, followed by a hand moving from a high position to a low position, and another hand moving from a high position to a low position.</p>
glorious	<p>The signwriting for 'glorious' consists of a hand moving from a high position to a low position, followed by a hand moving from a high position to a low position, and a hand moving from a high position to a low position.</p>



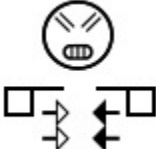

ASL Bible Dictionary

Spoken Word	SignWriting
glory	
glory	
glory	
glory	
glory	
glow	



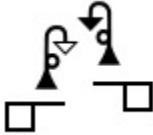
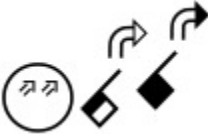

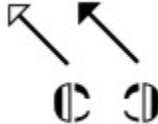
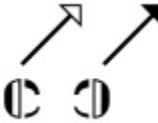

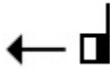
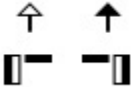
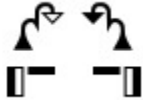
ASL Bible Dictionary

Spoken Word	SignWriting
glucocorticoids	 <p>A vertical sequence of 15 distinct handshapes and movements representing the word 'glucocorticoids' in SignWriting.</p>
gnash-teeth	 <p>SignWriting for 'gnash-teeth' featuring a circular face with teeth and arrows pointing inward, and two rectangular handshapes with arrows pointing toward each other.</p>
gnash-teeth	 <p>SignWriting for 'gnash-teeth' featuring a circular face with teeth, two diamond-shaped handshapes, and a circular handshape with a central dot.</p>
gnat	 <p>SignWriting for 'gnat' featuring a rectangular handshape with a diagonal line, a diamond-shaped handshape, and a square handshape.</p>
gnat	 <p>SignWriting for 'gnat' featuring a wavy arrow pointing left and a circular handshape with three radiating lines.</p>

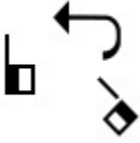

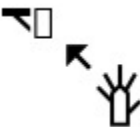
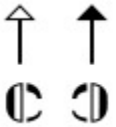
ASL Bible Dictionary

Spoken Word	SignWriting
go	
go	
go	
go	
go	
go	
go	
go-ahead	
go-ahead	





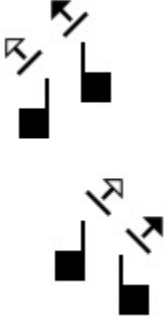

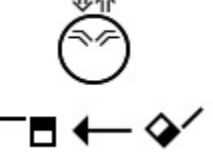
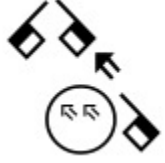
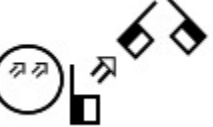
ASL Bible Dictionary

Spoken Word	SignWriting
go-around	
go-away	
go-away	
go-away	
go-group	
go-to	
go-to	
go-to	

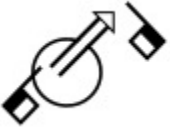

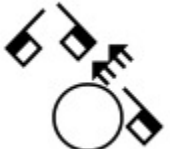

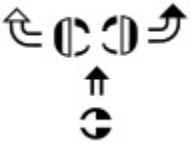
ASL Bible Dictionary

Spoken Word	SignWriting
go-to	
go-to	
go-to	
go-to-it	
goal	
goal	



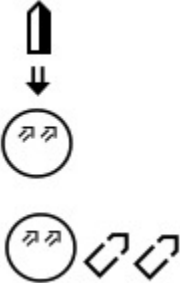

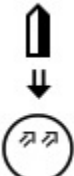
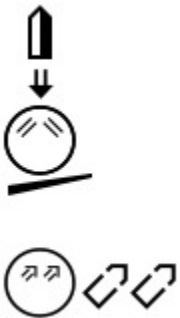

ASL Bible Dictionary

Spoken Word	SignWriting
goal	
goal	
goals	
goat	
goblet	
goblet	
god	

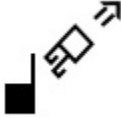



ASL Bible Dictionary

Spoken Word	SignWriting
God	
God	
God	
God	
God	
God	



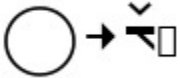

ASL Bible Dictionary

Spoken Word	SignWriting
God draws	
God shows	
goddess	
godless	
godly	
gods	



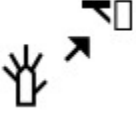

ASL Bible Dictionary

Spoken Word	SignWriting
Goliath	
Goliath	
Gomer	
Gomer	
Gomorrah	
gone	

ASL Bible Dictionary

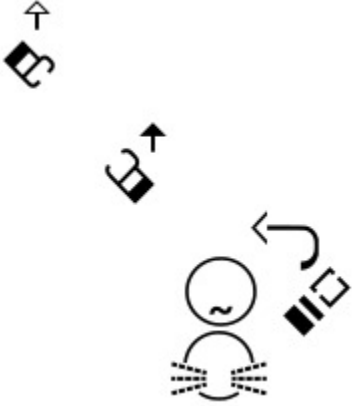
Spoken Word	SignWriting
gone	
gone	
gone	
gone	

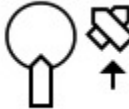
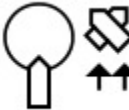
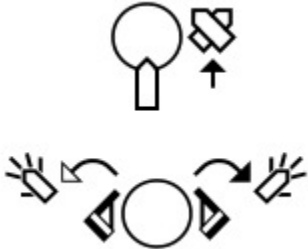



ASL Bible Dictionary

Spoken Word	SignWriting
gone	
gong	
good	
good	
good	
Good-News	
goodness	



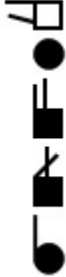

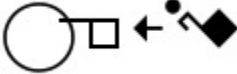
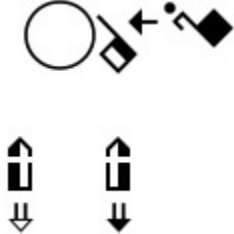
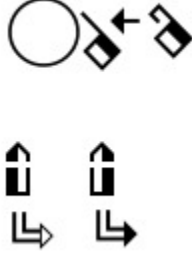

ASL Bible Dictionary

Spoken Word	SignWriting
gopher	<p>The signwriting for 'gopher' consists of a vertical sequence of symbols: a square with a horizontal line through its center, a solid black circle, a diamond with a diagonal line from top-left to bottom-right, a square with a horizontal line through its center, a solid black square, and a square with a diagonal line from top-left to bottom-right.</p>
gorilla	<p>The signwriting for 'gorilla' consists of two diamond shapes. The left diamond has an asterisk above it and a downward arrow below it. The right diamond has an asterisk above it and a downward arrow below it.</p>
Goshen	<p>The signwriting for 'Goshen' consists of a vertical sequence of symbols: a square with a horizontal line through its center, a solid black circle, a square with a horizontal line through its center, a solid black square, and a square with a diagonal line from top-left to bottom-right.</p>
Gospel	<p>The signwriting for 'Gospel' consists of a circle with a vertical line extending downwards from its center, a diamond with a diagonal line from top-left to bottom-right, and two hand symbols with fingers spread, one on the left and one on the right, with curved arrows indicating movement towards a central circle.</p>
gospels	<p>The signwriting for 'gospels' consists of a hand symbol with fingers spread, a diamond with a diagonal line from top-left to bottom-right, and a circle with a vertical line extending downwards from its center.</p>
gossip	<p>The signwriting for 'gossip' consists of two diamond shapes with a diagonal line from top-left to bottom-right, one on the left and one on the right. Below each diamond is a vertical line with a downward arrow at the bottom.</p>



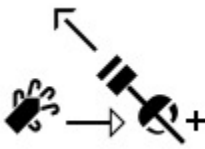

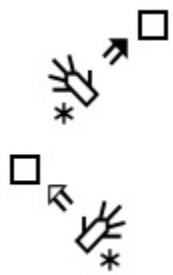

ASL Bible Dictionary

Spoken Word	SignWriting
gouge	
gourd	
government	
government	
governor	
governors	
grab	

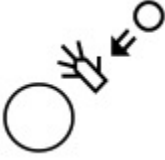

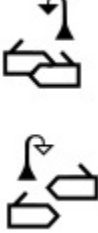

ASL Bible Dictionary

Spoken Word	SignWriting
grab	
grab	
grab	
grab	
grab	
grab	
grab	
grace	





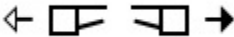

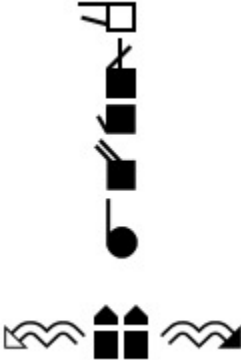
ASL Bible Dictionary

Spoken Word	SignWriting
grace	
grace	
grace	
gracious	
gradual	
graduate	
grafted	





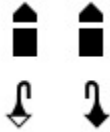

ASL Bible Dictionary

Spoken Word	SignWriting
grain	
grain	
grain	
grammar	
grand	
grand	
grandchildren	

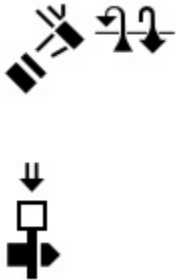

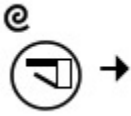

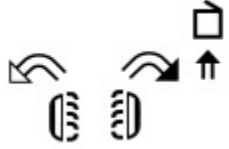

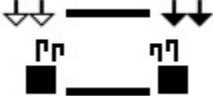

ASL Bible Dictionary

Spoken Word	SignWriting
grandfather	
grandmother	
grape	
grasp	
grass	
grave	
grave	





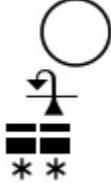

ASL Bible Dictionary

Spoken Word	SignWriting
gravity	
gray	
gray	
GRE	
great	
greater	
greatest	
greatly	
greed	





ASL Bible Dictionary

Spoken Word	SignWriting
greedy	
Greek	
green	
greet	
greet	
greetings	
grief	
grieve	





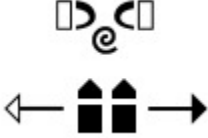

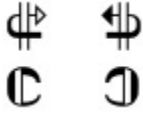
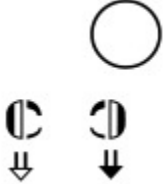
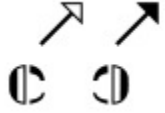
ASL Bible Dictionary

Spoken Word	SignWriting
Griffith	 <p>The SignWriting for 'Griffith' consists of a vertical sequence of eight symbols: a square with a diagonal line, a square with a diagonal line, a square with a diagonal line, a circle with a dot, a circle with a dot, a square with a diagonal line, a square with a diagonal line, and a square with a diagonal line.</p>
grind	 <p>The SignWriting for 'grind' consists of a circle containing a gear-like symbol, followed by three arrows pointing up, down, and up, and a square with a diagonal line.</p>
grind	 <p>The SignWriting for 'grind' consists of three arrows pointing up, down, and up, and a square with a diagonal line.</p>
grind	 <p>The SignWriting for 'grind' consists of a square with a diagonal line, a square with a diagonal line, a square with a diagonal line, a square with a diagonal line, a square with a diagonal line, and a circle with a dot.</p>
grip-fish	 <p>The SignWriting for 'grip-fish' consists of a square with a diagonal line, a square with a diagonal line, a square with a diagonal line, and a square with a diagonal line.</p>
grisled	 <p>The SignWriting for 'grisled' consists of a circle containing a square with a diagonal line, followed by a square with a diagonal line, a square with a diagonal line, and three arrows pointing up, down, and up.</p>

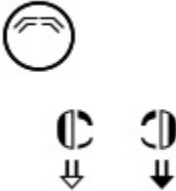
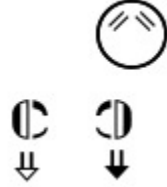
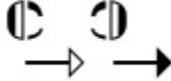
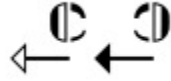

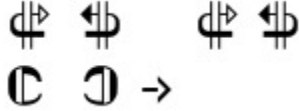

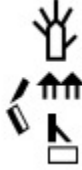

ASL Bible Dictionary

Spoken Word	SignWriting
groan	
groom	
grouch	
ground	
group	
group	
group	
group	

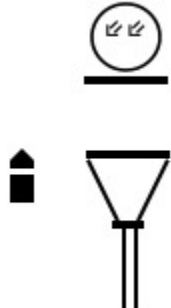

ASL Bible Dictionary

Spoken Word	SignWriting
group	
group	
group-go	
group-go	
groups	
groups	
grove	
grow	
grow	

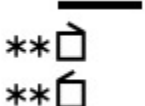





ASL Bible Dictionary

Spoken Word	SignWriting
grow	
grow	
grow	
grow up	
grow-up	
grow-up	
Guard	
guard	

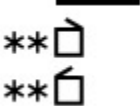
ASL Bible Dictionary

Spoken Word	SignWriting
guard	 <p>The SignWriting symbol for 'guard' (noun) consists of two crossed hands. The left hand is on the left and the right hand is on the right. Both hands have their index fingers pointing upwards. A tilde (~) is written above the right hand, and a closing parenthesis) is written below the crossing point.</p>
guard	 <p>The SignWriting symbol for 'guard' (verb) consists of two hands, one above the other. The top hand has its index finger pointing up. The bottom hand is a closed fist with its index finger pointing down. Below the fist are two vertical bars, each with an upward-pointing arrow above it and a downward-pointing arrow below it.</p>
guardians	 <p>The SignWriting symbol for 'guardians' consists of two hands, one above the other. The top hand has its index finger pointing up. The bottom hand is a closed fist with its index finger pointing down. Below the fist are two vertical bars, each with an upward-pointing arrow above it and a rightward-pointing arrow below it.</p>

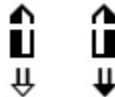

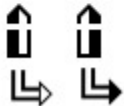

ASL Bible Dictionary

Spoken Word	SignWriting
guards	
guards	
Guatemala	
guess	
guest	
guest	
guests	
guests	



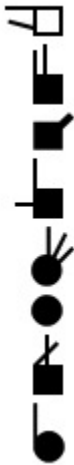

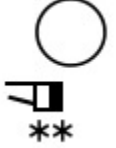
ASL Bible Dictionary

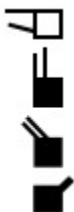
Spoken Word	SignWriting
<p>guests</p>	<p>The signwriting for 'guests' consists of a hand starting with the index finger pointing up, moving to the right, then down, and finally left. Below this is a small asterisk and a hand icon. At the bottom, there are two hand icons, each with an arrow pointing right from the index finger, indicating a specific hand movement or direction.</p>
<p>Guggenheim</p>	<p>The signwriting for 'Guggenheim' is a vertical sequence of hand movements. It starts with a hand icon, followed by a series of horizontal lines and hand icons, representing the letters of the name in a stylized, vertical format.</p>
<p>guide</p>	<p>The signwriting for 'guide' shows a hand icon with an arrow pointing up and to the right, indicating the direction of the sign.</p>
<p>guide</p>	<p>The signwriting for 'guide' shows a hand icon with an arrow pointing up and to the right, indicating the direction of the sign.</p>
<p>guide</p>	<p>The signwriting for 'guide' shows a hand icon with an arrow pointing up and to the right, indicating the direction of the sign.</p>
<p>guide-down</p>	<p>The signwriting for 'guide-down' shows a hand icon with an arrow pointing down and to the left, indicating the direction of the sign.</p>

ASL Bible Dictionary

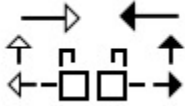
Spoken Word	SignWriting
<p>Guilford</p>	
<p>guilt</p>	
<p>guilt</p>	
<p>gun</p>	
<p>gunboats</p>	
<p>Guni</p>	

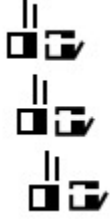

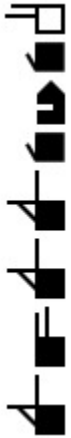

ASL Bible Dictionary

Spoken Word	SignWriting
gutters	
gymnastics	
H	
ha ha ha	
Habakkuk	
Habakkuk	





ASL Bible Dictionary

Spoken Word	SignWriting
habeas	
habit	
habit	
Hacaliah	
Hadad	



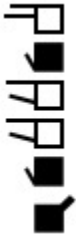

ASL Bible Dictionary

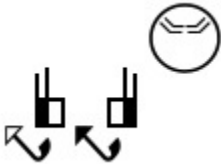
Spoken Word	SignWriting
Hadar	
Hadassah	
Hadid	
Hadoram	
Hagabah	



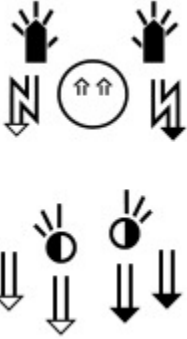

ASL Bible Dictionary

Spoken Word	SignWriting
Hagar	
Haggai	
Haggedolim	
Haggi	
Hai	
hail	

ASL Bible Dictionary

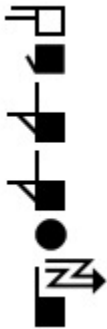
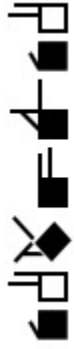
Spoken Word	SignWriting
hail	
hail	
hair	
hairy	
hakerem	

ASL Bible Dictionary

Spoken Word	SignWriting
Hakkoz	
Hakupha	
Hale	
half	
halfway	





ASL Bible Dictionary

Spoken Word	SignWriting
Hall	<p>The SignWriting for 'Hall' consists of a vertical sequence of four signs: a hand sign with fingers spread, a hand sign with fingers spread and palm facing left, a hand sign with fingers spread and palm facing left, and a hand sign with fingers spread and palm facing left.</p>
Hallohesh	<p>The SignWriting for 'Hallohesh' consists of a vertical sequence of seven signs: a hand sign with fingers spread, a hand sign with fingers spread and palm facing left, a hand sign with fingers spread and palm facing left, a hand sign with fingers spread and palm facing left, a hand sign with fingers spread and palm facing left, a hand sign with fingers spread and palm facing left, and a hand sign with fingers spread and palm facing left.</p>
Haloohesh	<p>The SignWriting for 'Haloohesh' consists of a vertical sequence of seven signs: a hand sign with fingers spread, a hand sign with fingers spread and palm facing left, a hand sign with fingers spread and palm facing left, a hand sign with fingers spread and palm facing left, a hand sign with fingers spread and palm facing left, a hand sign with fingers spread and palm facing left, and a hand sign with fingers spread and palm facing left.</p>
halted	<p>The SignWriting for 'halted' consists of a vertical sequence of two signs: a hand sign with fingers spread and palm facing left, and a hand sign with fingers spread and palm facing left.</p>





ASL Bible Dictionary

Spoken Word	SignWriting
halted	<p>The sign for 'halted' is written vertically. It begins with a square symbol containing a 'P' (for 'halt'). This is followed by a series of horizontal lines, some with small vertical ticks, representing the word 'halt'. The final stroke is a solid black circle.</p>
Ham	<p>The sign for 'Ham' is written vertically. It starts with a square symbol containing a 'P' (for 'ham'). This is followed by a series of diagonal lines slanting downwards to the right, representing the word 'ham'.</p>
Haman	<p>The sign for 'Haman' is written vertically. It begins with a square symbol containing a 'P' (for 'haman'). This is followed by a series of diagonal lines slanting downwards to the right, representing the word 'haman'.</p>
Haman	<p>The sign for 'Haman' is written vertically. It starts with a square symbol containing a lightning bolt (representing 'haman'). This is followed by a square symbol containing a 'P' (representing 'haman').</p>
Hamathite	<p>The sign for 'Hamathite' is written vertically. It begins with a square symbol containing a 'P' (for 'hamathite'). This is followed by a series of diagonal lines slanting downwards to the right, representing the word 'hamathite'. The final stroke is a solid black circle.</p>









ASL Bible Dictionary

Spoken Word	SignWriting
Hammedatha	
hammer	
Hamor	
Hamul	
Hanan	

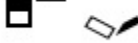
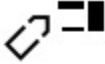
ASL Bible Dictionary

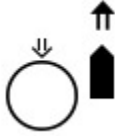
Spoken Word	SignWriting
Hanan	
Hananel	
Hananiah	
Hananiah	
Hancock	

ASL Bible Dictionary

Spoken Word	SignWriting
hand	
hand	
hand	
hand-hold	 
hand-lift	
hand-over	
handfull	
handfulls	





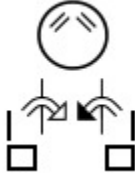
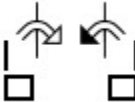
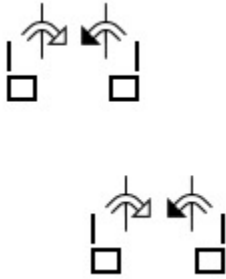
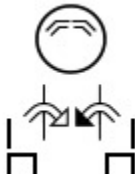
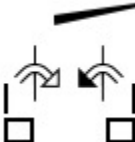

ASL Bible Dictionary

Spoken Word	SignWriting
hang	<p>The signwriting for 'hang' consists of a circle on the left with a small 'h' and an arrow pointing up and to the right. To its right is a vertical line with an upward-pointing arrow, and a horizontal line extending to the right from the base of the vertical line.</p>
hanging	<p>The signwriting for 'hanging' features a small square with a plus sign above it, connected by a diagonal line to a larger square. From the bottom-right corner of the larger square, a diagonal line extends downwards and to the right, ending in three arrows pointing in that direction.</p>
Hanoch	<p>The signwriting for 'Hanoch' is a vertical sequence of five symbols: a square with a horizontal line above it, a square with a diagonal line from top-left to bottom-right, a solid black circle, a square with a horizontal line below it, and another square with a horizontal line above it.</p>
Hanoch	<p>The signwriting for 'Hanoch' is a vertical sequence of five symbols: a square with a horizontal line above it, a square with a diagonal line from top-left to bottom-right, a solid black circle, a square with a horizontal line below it, and another square with a horizontal line above it.</p>
Hanukkah	<p>The signwriting for 'Hanukkah' is a vertical sequence of seven symbols: a square with a horizontal line above it, a square with a diagonal line from top-left to bottom-right, a square with a horizontal line below it, a solid black square, a square with a horizontal line below it, a square with a diagonal line from top-left to bottom-right, and a square with a horizontal line above it.</p>

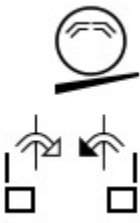



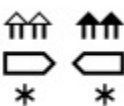

ASL Bible Dictionary

Spoken Word	SignWriting
Hanun	
happen	
happen	
happen	
happen	
happen	









ASL Bible Dictionary

Spoken Word	SignWriting
happen	
happy	
happy	
happy	
happy	
happy	





ASL Bible Dictionary

Spoken Word	SignWriting
happy	
happy	
Haran	
Haran	
harass	
harass	
Harbona	







ASL Bible Dictionary

Spoken Word	SignWriting
harbor	
hard	
hard	
hard	
hard	
hard-hearing	
harder	
harem	





ASL Bible Dictionary

Spoken Word	SignWriting
Harhaiah	
Harhur	
Harim	
Hariph	
harmony	

ASL Bible Dictionary

Spoken Word	SignWriting
harmony	
harmony	
harp	
harp	
harp	
Harsha	



ASL Bible Dictionary

Spoken Word	SignWriting
Hartford	 <p>The SignWriting for 'Hartford' consists of a vertical sequence of symbols: a square with a horizontal line on top, a square with a diagonal line from top-left to bottom-right, a square with a diagonal line from top-right to bottom-left, a square with a horizontal line on top, a circle with three lines radiating from the top-right, a solid black circle, a square with a diagonal line from top-left to bottom-right, and a solid black circle.</p>
Harumaph	 <p>The SignWriting for 'Harumaph' consists of a vertical sequence of symbols: a square with a horizontal line on top, a square with a diagonal line from top-left to bottom-right, a square with a diagonal line from top-right to bottom-left, a square with a horizontal line on top, a square with a diagonal line from top-left to bottom-right, a square with a diagonal line from top-right to bottom-left, a diamond shape, and a square with a horizontal line on top.</p>
harvard	 <p>The SignWriting for 'harvard' consists of a vertical sequence of symbols: a square with a horizontal line on top, a square with a diagonal line from top-left to bottom-right, a square with a diagonal line from top-right to bottom-left, a square with a horizontal line on top, a square with a diagonal line from top-left to bottom-right, a square with a diagonal line from top-right to bottom-left, and a solid black circle.</p>
harvest	 <p>The SignWriting for 'harvest' consists of a vertical sequence of symbols: a curved line resembling the number '3', a square with a diagonal line from top-left to bottom-right, and a square with a horizontal line on top.</p>



ASL Bible Dictionary

Spoken Word	SignWriting
harvester	<p>The signwriting for 'harvester' consists of two parts. The top part shows a hand starting with the index finger pointing up, moving in a circular path to the left, then down, and finally back up. The bottom part shows two hands, each with the index finger pointing up and a downward arrow below it, indicating a downward movement.</p>
harvesters	<p>The signwriting for 'harvesters' is similar to 'harvester' but includes an additional movement. The top part is the same circular hand movement. The bottom part shows two hands with index fingers pointing up and downward arrows, but each hand also has a small arrow pointing to the right, indicating a rightward movement.</p>
harvests	<p>The signwriting for 'harvests' features a hand starting with the index finger pointing up, moving in a circular path to the left, then down, and finally back up. This is followed by a second, identical circular movement.</p>
has	<p>The signwriting for 'has' shows two hands with index fingers pointing up and slightly outwards. Below each hand is an asterisk, which typically represents a specific handshape or a final movement in the sign.</p>
Hashabiah	<p>The signwriting for 'Hashabiah' is a vertical sequence of eight distinct hand movements, each represented by a different handshape and orientation.</p>





ASL Bible Dictionary

Spoken Word	SignWriting
Hashabiah	
Hashabnah	
Hashabneiah	





ASL Bible Dictionary

Spoken Word	SignWriting
<p>Hashbaddanah</p>	
<p>Hashum</p>	
<p>Hassenaah</p>	



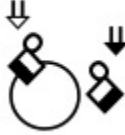

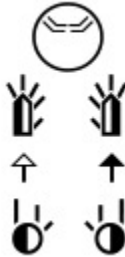
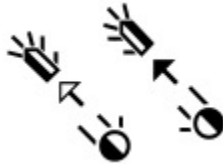
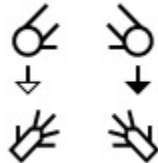

ASL Bible Dictionary

Spoken Word	SignWriting
Hassenuah	
Hasshub	
Hassophereth	
Hasupha	

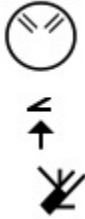



ASL Bible Dictionary

Spoken Word	SignWriting
hat	
hat	
hat	
hate	
hate	
hate	
hate	

ASL Bible Dictionary

Spoken Word	SignWriting
hatred	
Hattil	
Hattush	
haughty	
haughty	
have	
have	



ASL Bible Dictionary

Spoken Word	SignWriting
have	 <p>The signwriting for 'have' consists of a circle with two short horizontal lines inside, representing eyes. Below the circle are two hands, each with a small asterisk below it, indicating a specific handshape or movement.</p>
have	 <p>The signwriting for 'have' is similar to the first instance but includes a vertical line with an upward-pointing arrow above it, positioned between the eyes and the hands.</p>
Havens	 <p>The signwriting for 'Havens' is a vertical sequence of symbols: a square with a horizontal line, a square with a diagonal line, a square with a horizontal line, a square with a diagonal line, and a square with a horizontal line.</p>
Havilah	 <p>The signwriting for 'Havilah' is a vertical sequence of symbols: a square with a horizontal line, a square with a diagonal line, a square with a horizontal line, a square with a diagonal line, a square with a horizontal line, a square with a diagonal line, and a square with a horizontal line.</p>
Havilah	 <p>The signwriting for 'Havilah' is a vertical sequence of symbols: a square with a horizontal line, a square with a diagonal line, a square with a horizontal line, a square with a diagonal line, a square with a horizontal line, a square with a diagonal line, and a square with a horizontal line.</p>





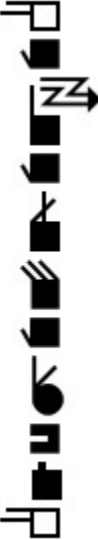

ASL Bible Dictionary

Spoken Word	SignWriting
hay	
Hazel	
Hazaiah	
Hazar	









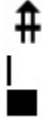

ASL Bible Dictionary

Spoken Word	SignWriting
<p>Hazarmaveth</p>	
<p>hazel</p>	
<p>Hazezontamar</p>	







ASL Bible Dictionary

Spoken Word	SignWriting
hazmat	
Hazo	
Hazor	
hazzebaim	
He	
He	
he	



ASL Bible Dictionary

Spoken Word	SignWriting
He	
he	
he	
he	
he	
he	
he	
he	
he	
he	
he	





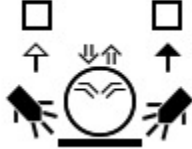
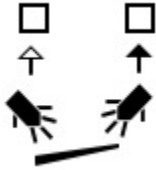
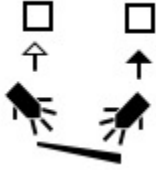
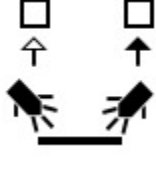
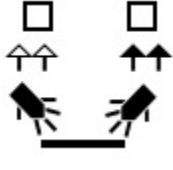
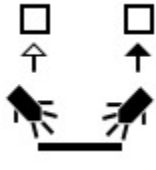



ASL Bible Dictionary

Spoken Word	SignWriting
he	
He	
He	
He-above	
head	
headquarters	







ASL Bible Dictionary

Spoken Word	SignWriting
headquarters	
heal	
heal	
heal	
healed	
healing	
healthy	
heaping	



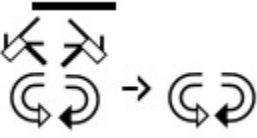

ASL Bible Dictionary

Spoken Word	SignWriting
heaps	
hear	
hear	
hear	
hearing-aid	
hears	
heart	
heart	
heart	





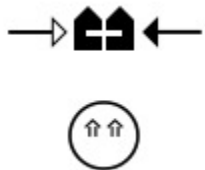
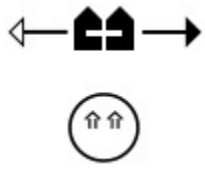

ASL Bible Dictionary

Spoken Word	SignWriting
heart	
heartbreak	
hearts	
heathen	
heaven	
heaven	

ASL Bible Dictionary

Spoken Word	SignWriting
heaven	
heaven	
heaven	
heaven	
heaven	
heaven-doors-close	
heaven-open	





ASL Bible Dictionary

Spoken Word	SignWriting
heavens	
heavy	
Heber	
Hebrew	
Hebrew	
Hebrews	

ASL Bible Dictionary

Spoken Word	SignWriting
Hebrews08v10a NLT	
Hebrews08v10b NLT	
Hebrews08v11 NLT	
Hebrews08v12 NLT	
Hebrews08v13 NLT	
Hebrews09v01 NLT	
Hebrews09v02 NLT	
Hebrews09v03 NLT	
Hebrews09v04a NLT	
Hebrews09v04b NLT	
Hebrews09v05 NLT	
Hebrews09v06 NLT	
Hebrews09v07 NLT	
Hebrews09v08 NLT	
Hebrews09v09 NLT	
Hebrews09v10 NLT	
Hebrews09v11 NLT	
Hebrews09v12 NLT	
Hebrews09v13 NLT	



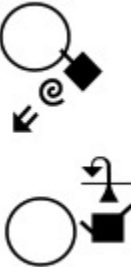





ASL Bible Dictionary

Spoken Word	SignWriting
Hebron	
heel	
heel	
Hegai	
heifer	

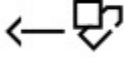

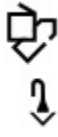

ASL Bible Dictionary

Spoken Word	SignWriting
heir	<p>The signwriting for 'heir' consists of three parts: a diamond shape with a 'P' above it and arrows indicating movement, and two vertical rectangles below it, each with arrows pointing up and down.</p>
heirs	<p>The signwriting for 'heirs' consists of three parts: a diamond shape with a 'P' above it and arrows indicating movement, and two vertical rectangles below it, each with arrows pointing up and then right.</p>
Heli	<p>The signwriting for 'Heli' consists of a vertical sequence of symbols: a diamond with a horizontal line above it, a vertical line, a horizontal line, a vertical line, and a diamond.</p>
helicopter	<p>The signwriting for 'helicopter' consists of a hand symbol with fingers spread, a vertical line, and a propeller symbol.</p>
heliopause	<p>The signwriting for 'heliopause' is a vertical sequence of symbols: a diamond with a horizontal line above it, a vertical line, a horizontal line, a diamond, a circle, a diamond, a vertical line, a horizontal line, and a vertical line.</p>

ASL Bible Dictionary

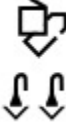
Spoken Word	SignWriting
help	
help	
help	
help	
help	
help	
help me	
help you	
help-me	
help-me	

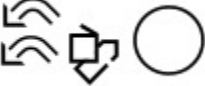
ASL Bible Dictionary

Spoken Word	SignWriting
helpful	
helping	
helps	
helps	
Hemam	
Hemdan	

ASL Bible Dictionary

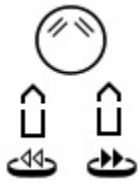
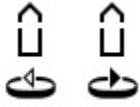
Spoken Word	SignWriting
here	
here	
here	
here	





ASL Bible Dictionary

Spoken Word	SignWriting
heresies	<p>The SignWriting for 'heresies' consists of a vertical sequence of signs: a hand sign for 'H', followed by 'R', 'E', 'S', 'I', 'E', 'S', 'I', 'E', 'S'.</p>
heresy	<p>The SignWriting for 'heresy' consists of a vertical sequence of signs: a hand sign for 'H', followed by 'R', 'E', 'S', 'I', 'S', 'Y'.</p>
Hermas	<p>The SignWriting for 'Hermas' consists of a vertical sequence of signs: a hand sign for 'H', followed by 'E', 'R', 'M', 'A', 'S'.</p>
Hermes	<p>The SignWriting for 'Hermes' consists of a vertical sequence of signs: a hand sign for 'H', followed by 'E', 'R', 'M', 'E', 'S'.</p>
hero	<p>The SignWriting for 'hero' consists of a horizontal sequence of signs: a hand sign for 'H', followed by 'E', 'R', 'O'.</p>





ASL Bible Dictionary

Spoken Word	SignWriting
hero	
Herod	
Herodias	
Herodias	
Herodion	



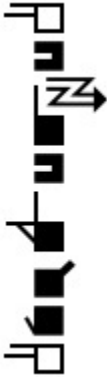

ASL Bible Dictionary

Spoken Word	SignWriting
Herter	
Hertford	
Heshbon	
Hester	

ASL Bible Dictionary

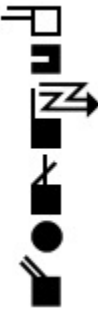
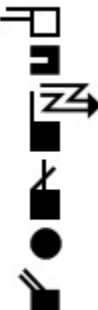
Spoken Word	SignWriting
Heth	
Hey	
hey	
Hezekiah	
Hezir	

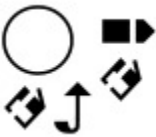





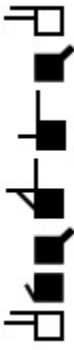

ASL Bible Dictionary

Spoken Word	SignWriting
Hezron	
Hezron	
Hiddekel	
hide	
hide	

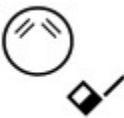







ASL Bible Dictionary

Spoken Word	SignWriting
hides	<p>The signwriting for 'hides' consists of a vertical sequence of symbols: a square with a horizontal line extending to the right, a solid black square, a horizontal line with a solid black circle below it, and another solid black square.</p>
Hierapolis	<p>The signwriting for 'Hierapolis' is a vertical sequence of symbols: a square with a horizontal line extending to the right, a solid black square, a square with a horizontal line extending to the right, a solid black square, a diamond shape with a diagonal line from the top-left to the bottom-right, a solid black circle, a horizontal line with a solid black square below it, and another solid black square.</p>
high	<p>The signwriting for 'high' consists of a solid black square with an upward-pointing arrow above it, and a square with a horizontal line extending to the right below it.</p>
high	<p>The signwriting for 'high' consists of a square with a horizontal line extending to the right, and two upward-pointing arrows above it.</p>
highest	<p>The signwriting for 'highest' consists of a solid black square with a downward-pointing arrow above it, a square with a horizontal line extending to the right, and a solid black square with a vertical line extending downwards from its bottom center.</p>
highest	<p>The signwriting for 'highest' features a central circle. To its left is a square with a horizontal line extending to the right and an upward-pointing arrow above it. To its right is a vertical stack of symbols: a square with a horizontal line extending to the right, an upward-pointing arrow above it, another square with a horizontal line extending to the right, and a final upward-pointing arrow above it.</p>







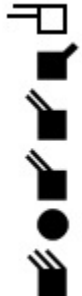

ASL Bible Dictionary

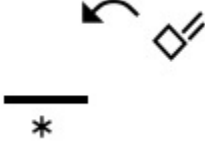
Spoken Word	SignWriting
Hilkiah	
hill	
Hill	
him	
him	
him	
him	
Him	
Him-eup-	









ASL Bible Dictionary

Spoken Word	SignWriting
Him-nod	
himself	
himself	
Himself	
Himself	
Himself	
Himself	
hinder	
Hinnom	







ASL Bible Dictionary

Spoken Word	SignWriting
Hirah	
hired	
his	
his	
his	
his	
his	
his	
his	
his	

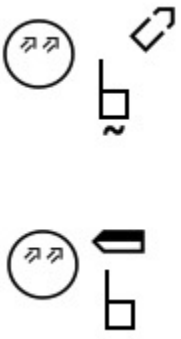



ASL Bible Dictionary

Spoken Word	SignWriting
his	
his	
his	
his	
his	
His	
His-above	
His-Blood-Saves	





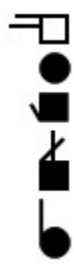

ASL Bible Dictionary

Spoken Word	SignWriting
His-shelter	
history	
history	
hit	
hit	
hit teeth	
hits	









ASL Bible Dictionary

Spoken Word	SignWriting
Hittites	
Hivite	
Hivites	
Hmm	
hoard	

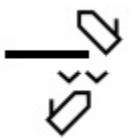

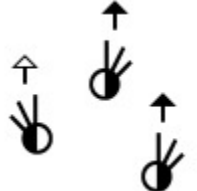

ASL Bible Dictionary

Spoken Word	SignWriting
Hobah	
Hodaviah	
Hodiah	
hold	
hold	
hold	

ASL Bible Dictionary

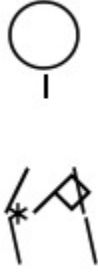
Spoken Word	SignWriting
hold	
hold	
hold-baby	
hold-shield	
hole	
hole in stomach	
holes	
Holiday	
holiday	

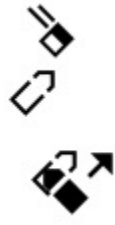



ASL Bible Dictionary

Spoken Word	SignWriting
hollow-of-the-thigh	
Hollywood	
Hollywood	
holy	
home	
Honduras	

ASL Bible Dictionary

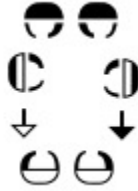
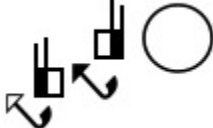
Spoken Word	SignWriting
honey	

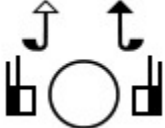
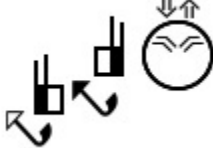



ASL Bible Dictionary

Spoken Word	SignWriting
honey	
honeycomb	
honor	
honor	
honor	
honor	
honoring	
hooked	







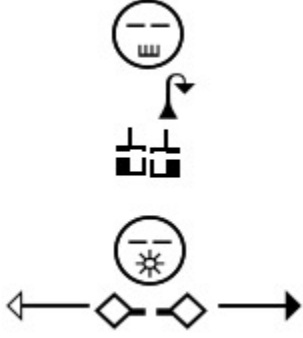

ASL Bible Dictionary

Spoken Word	SignWriting
hooks	<p>The sign for 'hooks' is written vertically. It starts with a square symbol, followed by two solid black circles, then a horizontal line with a downward-pointing arrow, and ends with a solid black square.</p>
Hoover	<p>The sign for 'Hoover' is written vertically. It starts with a square symbol, followed by two solid black circles, then a horizontal line with a downward-pointing arrow, then a solid black square, and ends with a horizontal line with a downward-pointing arrow.</p>
hope	<p>The sign for 'hope' is written vertically. It starts with a horizontal line with a downward-pointing arrow, followed by a circle, and ends with a horizontal line with a downward-pointing arrow.</p>
hopes	<p>The sign for 'hopes' is written vertically. It starts with a horizontal line with a downward-pointing arrow, followed by a circle, and ends with a horizontal line with a downward-pointing arrow.</p>
Hopkins	<p>The sign for 'Hopkins' is written vertically. It starts with a square symbol, followed by a solid black circle, then a diamond shape with a downward-pointing arrow, then a horizontal line with a downward-pointing arrow, then a solid black square, then a horizontal line with a downward-pointing arrow, and ends with a solid black square.</p>
hopping	<p>The sign for 'hopping' is written vertically. It starts with a square symbol, followed by a solid black circle, then a diamond shape with a downward-pointing arrow, then another diamond shape with a downward-pointing arrow, then a horizontal line with a downward-pointing arrow, and ends with a square symbol.</p>







ASL Bible Dictionary

Spoken Word	SignWriting
Horeb	
Horeb	
Hori	
Horites	
horizon	







ASL Bible Dictionary

Spoken Word	SignWriting
horn	
horn	
horn	
horns	
horns	
horns	
horns	
horns	
horns	







ASL Bible Dictionary

Spoken Word	SignWriting
Horonite	
horror	
horror	
horror	
Horse	
horse	
Hosea	

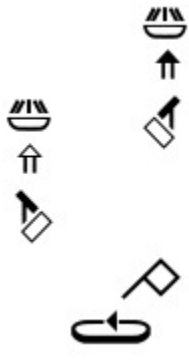

ASL Bible Dictionary

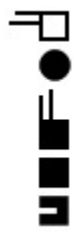
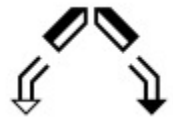
Spoken Word	SignWriting
Hosea	
Hoshaiah	
Hoshea	
hospital	
host	
hot	
hotel	

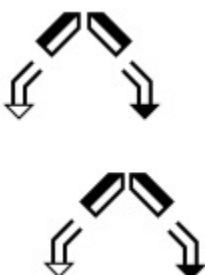

ASL Bible Dictionary

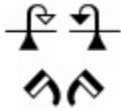
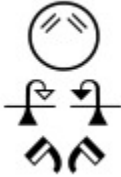
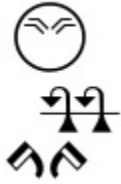
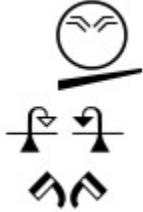
Spoken Word	SignWriting
hotspots	
hour	
hour	
hours	
House	
house	
house flat roof	
houses	

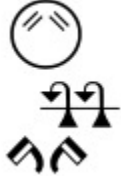
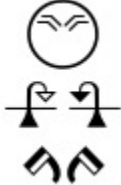



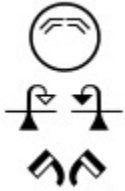
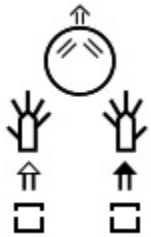
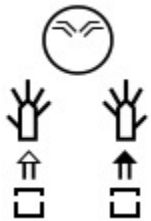

ASL Bible Dictionary

Spoken Word	SignWriting
how	
how	
how	
how	
how	
how	
how	



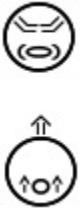



ASL Bible Dictionary

Spoken Word	SignWriting
how	
how	
how-many	
how-much	
how-you	
however	

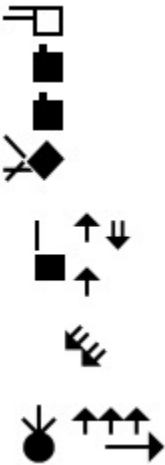



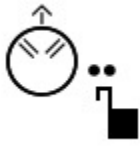

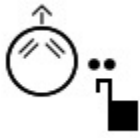
ASL Bible Dictionary

Spoken Word	SignWriting
however	 <p>The signwriting consists of two curved arrows pointing towards each other, one above the other, with two solid black diamonds positioned below them.</p>
however	 <p>The signwriting consists of a circle with two curved lines inside, positioned above three hand icons. The hand icons are arranged horizontally, with the middle one pointing right and the two outer ones pointing up.</p>
howl	 <p>The signwriting consists of a circle with a wavy line inside, positioned above another circle with an upward-pointing arrow above it and two upward-pointing arrows below it.</p>
hozeh	 <p>The signwriting consists of a vertical sequence of symbols: a square with a horizontal line extending to the right, a solid black circle, a zigzag line with an arrow pointing right, a solid black square, another square with a horizontal line extending to the right, and a final square with a horizontal line extending to the right.</p>
hq	 <p>The signwriting consists of a square with a horizontal line extending to the right, positioned above a solid black diamond.</p>
HQ	 <p>The signwriting consists of a square with a horizontal line extending to the right, positioned above a solid black diamond.</p>
hs	 <p>The signwriting consists of a square with a horizontal line extending to the right, positioned above a solid black square.</p>

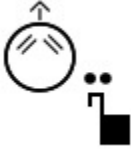

ASL Bible Dictionary

Spoken Word	SignWriting
<p>http://www</p>	 <p>The signwriting for 'http://www' consists of several distinct symbols: a square with a horizontal line extending to the left, a solid black square, another solid black square, a diamond with a diagonal line from top-left to bottom-right, a vertical line with an upward arrow, a solid black square with an upward arrow, a hand with fingers spread, a solid black circle with a vertical line extending upwards, and three horizontal arrows pointing to the right.</p>
<p>hug</p>	 <p>The signwriting for 'hug' features a curved arrow pointing up and to the right, two diamonds with asterisks on their left and right sides, and a vertical line with a horizontal crossbar.</p>
<p>hug</p>	 <p>The signwriting for 'hug' features two curved arrows pointing outwards, two diamonds with asterisks on their left and right sides, and a vertical line with a horizontal crossbar.</p>
<p>huge</p>	 <p>The signwriting for 'huge' features a curved arrow pointing up and to the left, two vertical lines with horizontal crossbars, and a curved arrow pointing up and to the right.</p>
<p>huh</p>	 <p>The signwriting for 'huh' features a circle with two horizontal lines inside and an upward arrow, and a solid black square with a vertical line extending upwards.</p>
<p>huh</p>	 <p>The signwriting for 'huh' features a circle with two horizontal lines inside, and two hands with fingers spread on either side.</p>
<p>huh</p>	 <p>The signwriting for 'huh' features a circle with two horizontal lines inside and an upward arrow, and a solid black square with a vertical line extending upwards.</p>

ASL Bible Dictionary

Spoken Word	SignWriting
huh	
huh	
huh	
huh	
huh	
huh	
huh	
Hul	

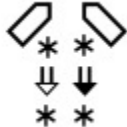
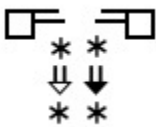
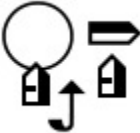

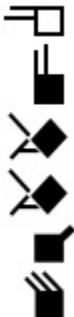
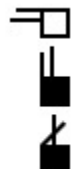
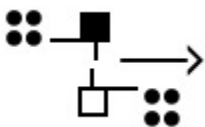
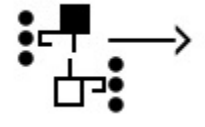

ASL Bible Dictionary

Spoken Word	SignWriting
hull	
human	
human	
humble	
Humphries	



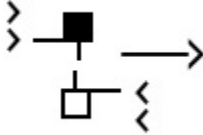

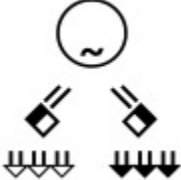
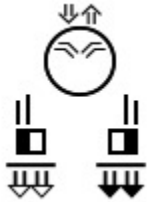
ASL Bible Dictionary

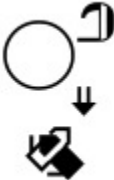
Spoken Word	SignWriting
Huppim	
Hur	
hurricane	
hurricane	

ASL Bible Dictionary

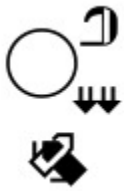
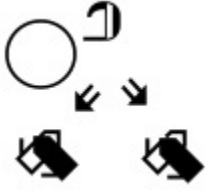
Spoken Word	SignWriting
hurricane	
hurry	
hurry	
hurry	
hurry	
husband	
husband	



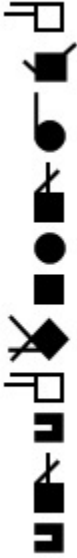
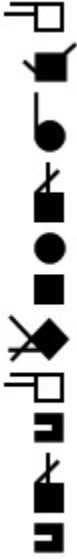

ASL Bible Dictionary

Spoken Word	SignWriting
husbands	
husbands	
hush	
Husham	
Hushim	
Huz	









ASL Bible Dictionary

Spoken Word	SignWriting
hydrogen	
hydrospere	
hydrosphere	

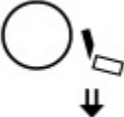
ASL Bible Dictionary

Spoken Word	SignWriting
Hymenaeus	
hymn	
hymns	
hyperosmolar	









ASL Bible Dictionary

Spoken Word	SignWriting
I	
I	
I	
I	
I	
I	
I	
I	





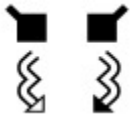



ASL Bible Dictionary

Spoken Word	SignWriting
I AM	<p>The signwriting for 'I AM' consists of three main components: a vertical line with a downward-pointing arrow, a circle, and a hand symbol with the index finger pointing up and to the right.</p>
I-AM	<p>The signwriting for 'I-AM' includes a circle containing two small arrows pointing towards each other, a hand symbol with the index finger pointing up and to the right, and a small asterisk symbol.</p>
i-f	<p>The signwriting for 'i-f' is represented by a solid black square and a hand symbol with the index finger pointing up and to the right.</p>
i-f	<p>The signwriting for 'i-f' consists of a circle with two parallel lines inside, positioned above a solid black square and a hand symbol with the index finger pointing up and to the right.</p>
I-He	<p>The signwriting for 'I-He' features a small square with a vertical line extending downwards to an asterisk, and a hand symbol with the index finger pointing up and to the right.</p>
I-love-you	<p>The signwriting for 'I-love-you' is composed of three parts: a small square with a vertical line to an asterisk, a central symbol consisting of two squares with a diagonal line between them and asterisks on either side, and a small square with a vertical line to an asterisk.</p>
I-r	<p>The signwriting for 'I-r' includes a horizontal line with a hook-like shape at its end, a hand symbol with the index finger pointing up and to the right, and a small asterisk symbol.</p>









ASL Bible Dictionary

Spoken Word	SignWriting
Iddo	
idea	
ideas	
identify	
idle	
idle	
idol	
idol	

ASL Bible Dictionary

Spoken Word	SignWriting
idol	
idols	
Idumea	
if	
if	
if	
if	
if	
if	



ASL Bible Dictionary

Spoken Word	SignWriting
if	
if	
if-not	
ignorant	
ignorant	
ignorant	
ignore	
ignore	
ignore	



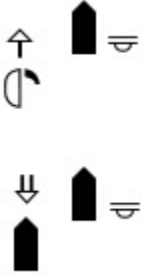
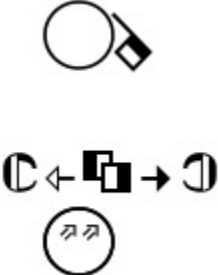
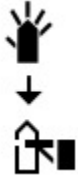

ASL Bible Dictionary

Spoken Word	SignWriting
illegal	
illegitimate	
Illinois	
Illyricum	
ILY	
ILY-2h	



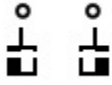

ASL Bible Dictionary

Spoken Word	SignWriting
ILY-lh	
image	
image	
imagine	
imitate	

ASL Bible Dictionary

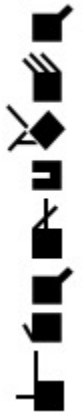
Spoken Word	SignWriting
Immanuel	
immature	
immediately	
Immer	
immoral	







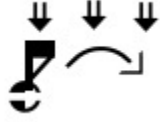

ASL Bible Dictionary

Spoken Word	SignWriting
impale	
Imperial	
important	
impossible	
impossible	
improve	







ASL Bible Dictionary

Spoken Word	SignWriting
<p>impure</p>	<p>The signwriting for 'impure' consists of two parts. The first part shows a hand with fingers curled, moving in a circular path around a central point, with an arrow indicating the direction of movement. Below this is a square symbol with a horizontal line through its center and an arrow pointing upwards from the right side. The second part shows a hand with fingers curled, moving in a circular path around a central point, with an arrow indicating the direction of movement.</p>
<p>Imri</p>	<p>The signwriting for 'Imri' consists of four parts. The first part is a square symbol with a horizontal line through its center and an arrow pointing upwards from the right side. The second part is a hand with fingers curled, moving in a circular path around a central point, with an arrow indicating the direction of movement. The third part is a square symbol with a horizontal line through its center and an arrow pointing upwards from the right side. The fourth part is a square symbol with a horizontal line through its center and an arrow pointing upwards from the right side.</p>
<p>in</p>	<p>The signwriting for 'in' is a single symbol consisting of a square with a horizontal line through its center and an arrow pointing upwards from the right side.</p>

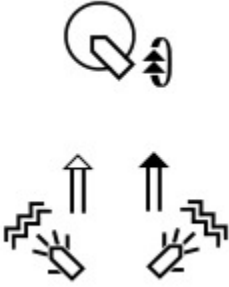

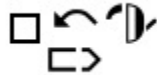

ASL Bible Dictionary

Spoken Word	SignWriting
in	
in	
in	
in-a-row	
in-fact	
in-general	
inalienable	
incence	

ASL Bible Dictionary

Spoken Word	SignWriting
incense	
incense	
include	
income	
increase	
indep	
India	



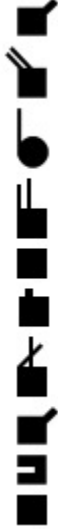
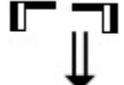

ASL Bible Dictionary

Spoken Word	SignWriting
India	
Indian	
indignant	
individual	
individuals	
industries	
inferior	

ASL Bible Dictionary

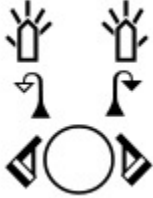
Spoken Word	SignWriting
influence	<p>The signwriting for 'influence' consists of three vertical elements: a downward-pointing arrow, a downward-pointing arrow, and a hand with fingers spread pointing downwards.</p>
influences	<p>The signwriting for 'influences' consists of three vertical elements: a hand with fingers spread pointing downwards, two upward-pointing arrows, and a downward-pointing arrow.</p>
inform	<p>The signwriting for 'inform' consists of two hands with fingers spread pointing downwards, two curved arrows pointing downwards, and a circle with two hands pointing towards it.</p>
inform	<p>The signwriting for 'inform' consists of two hands with fingers spread pointing downwards, two curved arrows pointing downwards, and a circle with two hands pointing towards it.</p>
inform	<p>The signwriting for 'inform' consists of two hands with fingers spread pointing downwards, two curved arrows pointing downwards, and a circle with two hands pointing towards it.</p>
inform	<p>The signwriting for 'inform' consists of two hands with fingers spread pointing downwards, two curved arrows pointing downwards, and a circle with two hands pointing towards it.</p>
inform	<p>The signwriting for 'inform' consists of two hands with fingers spread pointing downwards, two curved arrows pointing downwards, and a circle with two hands pointing towards it.</p>

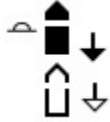

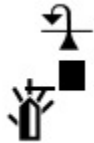
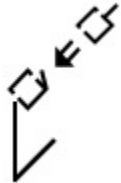



ASL Bible Dictionary

Spoken Word	SignWriting
information	
inhabited	
inherit	
inherit	
inheritance	
iniquity	
initiate	
inject	



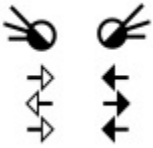

ASL Bible Dictionary

Spoken Word	SignWriting
ink	
inlaid	
inlaid	
inlaid	
inn	
innocent	



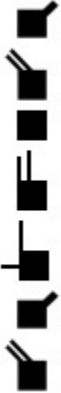
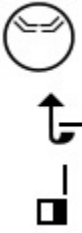

ASL Bible Dictionary

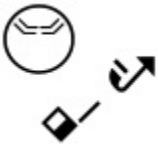
Spoken Word	SignWriting
inside	
inside	
inside	
inside	
inside	
insignificant	
insist	
insist	



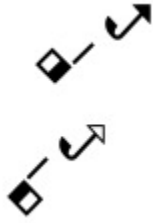
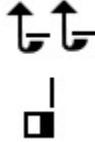



ASL Bible Dictionary

Spoken Word	SignWriting
institution	
instruct	
insulin	
insult	
insult	
insult	

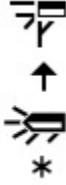
ASL Bible Dictionary

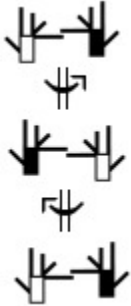
Spoken Word	SignWriting
insults	
insults	
intend	
interact	
interest	
interest	

ASL Bible Dictionary

Spoken Word	SignWriting
interests	
interests	
international	
Internet	
internet	
interpret	
interpret	

ASL Bible Dictionary

Spoken Word	SignWriting
<p>interpreter</p>	<p>The signwriting for 'interpreter' consists of four distinct hand movements arranged vertically. From top to bottom: 1. Two hands with fingers spread, palms facing each other, moving in a circular path. 2. Two hands with fingers spread, palms facing each other, held together. 3. Two hands, palms facing each other, with fingers pointing up, moving up and down. 4. Two hands, palms facing each other, with fingers pointing down, moving up and down.</p>
<p>interpreters</p>	<p>The signwriting for 'interpreters' consists of four distinct hand movements arranged vertically. From top to bottom: 1. Two hands with fingers spread, palms facing each other, moving in a circular path. 2. Two hands with fingers spread, palms facing each other, held together. 3. Two hands, palms facing each other, with fingers pointing up, moving up and down. 4. Two hands, palms facing each other, with fingers pointing down, moving up and down.</p>
<p>interrupt</p>	<p>The signwriting for 'interrupt' consists of a single hand movement. The hand is in a fist-like position with the index finger pointing up, moving in a circular path.</p>
<p>interstellar-medium</p>	<p>The signwriting for 'interstellar-medium' consists of a single hand movement. The hand is in a fist-like position with the index finger pointing up, moving in a circular path.</p>
<p>intertwine</p>	<p>The signwriting for 'intertwine' consists of a single hand movement. The hand is in a fist-like position with the index finger pointing up, moving in a circular path.</p>
<p>interview</p>	<p>The signwriting for 'interview' consists of a single hand movement. The hand is in a fist-like position with the index finger pointing up, moving in a circular path.</p>
<p>interviewer</p>	<p>The signwriting for 'interviewer' consists of a single hand movement. The hand is in a fist-like position with the index finger pointing up, moving in a circular path.</p>
<p>into</p>	<p>The signwriting for 'into' consists of a single hand movement. The hand is in a fist-like position with the index finger pointing up, moving in a circular path.</p>
<p>into</p>	<p>The signwriting for 'into' consists of a single hand movement. The hand is in a fist-like position with the index finger pointing up, moving in a circular path.</p>







ASL Bible Dictionary

Spoken Word	SignWriting
introduce	<p>The signwriting for 'introduce' consists of two identical hand movements. Each movement starts with the index finger pointing left, then curves down and right, ending with the index finger pointing right. Below each hand movement is a diamond shape with an asterisk underneath it.</p>
invade	<p>The signwriting for 'invade' features a central sequence of three squares: a black square, a white square, and a black square. An arrow points from the top of the white square to the top of the second black square. Below this, two hands are shown with fingers spread, moving towards each other. In the center, two squares (one white, one black) are positioned with arrows pointing towards each other.</p>
invent	<p>The signwriting for 'invent' shows a hand with fingers spread moving in a circular path around a circle. The hand starts at the top, moves right, then down, then left, and finally up, ending with the index finger pointing up.</p>
invest	<p>The signwriting for 'invest' depicts a hand with fingers spread moving in a circular path around a central point. The hand starts at the top, moves right, then down, then left, and finally up, ending with the index finger pointing up.</p>
investigate	<p>The signwriting for 'investigate' shows a hand with fingers spread moving in a circular path around a circle. The hand starts at the top, moves right, then down, then left, and finally up, ending with the index finger pointing up.</p>
investigator	<p>The signwriting for 'investigator' consists of three parts. The top part is a hand with fingers spread moving in a circular path around a circle. The middle part is a hand with fingers spread moving in a circular path around a central point. The bottom part consists of two vertical bars, each with an upward-pointing arrow above it and a downward-pointing arrow below it.</p>

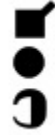
ASL Bible Dictionary

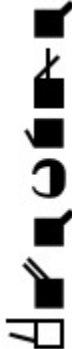
Spoken Word	SignWriting
investigators	<p>The signwriting for 'investigators' consists of four distinct symbols arranged vertically. The first symbol is a circle with a small square attached to its right side. The second symbol is a square with an arrow pointing up and to the right, and a solid black diamond below it. The third and fourth symbols are identical, each consisting of a vertical rectangle with an arrow pointing down and to the right from its bottom right corner.</p>
invisible	<p>The signwriting for 'invisible' is a single symbol showing a hand with the index finger pointing down and to the left, and the thumb pointing down and to the right, with a curved arrow indicating a circular motion between the two fingers.</p>
invites	<p>The signwriting for 'invites' consists of three symbols arranged vertically. The first symbol is a hand with the index finger pointing up and to the right, and the thumb pointing up and to the left. The second symbol is a small square with an arrow pointing down and to the right. The third symbol is an asterisk.</p>
invites	<p>The signwriting for 'invites' consists of three symbols arranged vertically. The first symbol is a hand with the index finger pointing up and to the right, and the thumb pointing up and to the left, with a curved arrow indicating a circular motion between the two fingers. The second symbol is a small square with an arrow pointing down and to the right. The third symbol is an asterisk.</p>



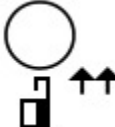

ASL Bible Dictionary

Spoken Word	SignWriting
IOC	
IR	
iracing	
Irad	
Iram	
iron	
iron	

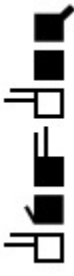

ASL Bible Dictionary

Spoken Word	SignWriting
isbn	
Iscah	
Iscariot	
Ishbak	
Ishmael	

ASL Bible Dictionary

Spoken Word	SignWriting
Ishmeelites	
Ishuah	
ISL	
islam	
island	
isolate	

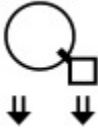
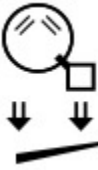
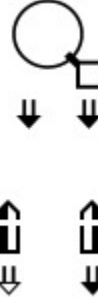
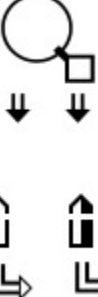



ASL Bible Dictionary

Spoken Word	SignWriting
Israel	
Israel	
Israelite	
Israelites	
Issachar	



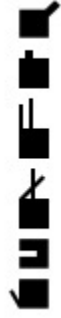
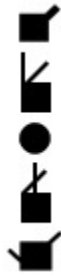

ASL Bible Dictionary

Spoken Word	SignWriting
Isui	
Italy	
Ithiel	
Ithran	
itself	
itself	
itself	

ASL Bible Dictionary

Spoken Word	SignWriting
Iturea	
ivory	
J	
Jaalah	
Jaalam	





ASL Bible Dictionary

Spoken Word	SignWriting
Jabal	
Jabbok	
Jachin	
jacinth	

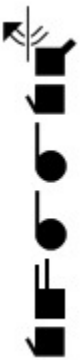

ASL Bible Dictionary

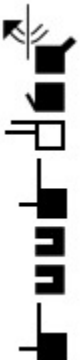
Spoken Word	SignWriting
Jackal's	<p>The SignWriting for 'Jackal's' consists of a sequence of signs: a hand sign with fingers spread, a hand sign with fingers curled, a hand sign with fingers spread, a hand sign with fingers curled, a hand sign with fingers spread, and a hand sign with fingers curled.</p>
Jacob	<p>The SignWriting for 'Jacob' consists of a sequence of signs: a hand sign with fingers spread, a hand sign with fingers curled, a hand sign with fingers spread, and a hand sign with fingers curled.</p>
Jacob	<p>The SignWriting for 'Jacob' consists of a sequence of signs: a hand sign with fingers spread, a hand sign with fingers curled, a hand sign with fingers spread, and a hand sign with fingers curled.</p>
Jacobs	<p>The SignWriting for 'Jacobs' consists of a sequence of signs: a hand sign with fingers spread, a hand sign with fingers curled, a hand sign with fingers spread, a hand sign with fingers curled, a hand sign with fingers spread, and a hand sign with fingers curled.</p>

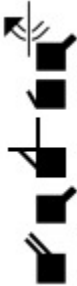

ASL Bible Dictionary

Spoken Word	SignWriting
Jaddua	
Jadon	
Jahleel	
Jahzeel	



ASL Bible Dictionary

Spoken Word	SignWriting
Jairus	
Jakin	
Jambres	
James	

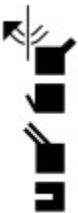
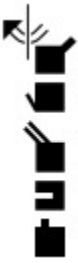
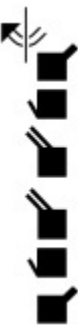

ASL Bible Dictionary

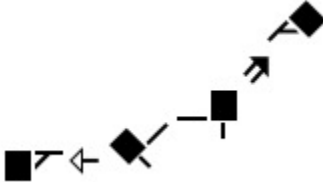
Spoken Word	SignWriting
Jamin	
Jamin	
Jane	
Janet	
Jannai	

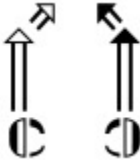
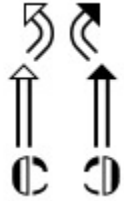

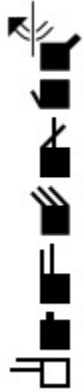
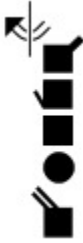

ASL Bible Dictionary

Spoken Word	SignWriting
Jannes	
Japan	
Japheth	
jar	
jar	
jar	

ASL Bible Dictionary

Spoken Word	SignWriting
Jared	
Jarmuth	
Jason	
jasper	

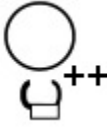
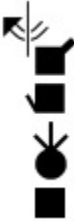

ASL Bible Dictionary

Spoken Word	SignWriting
Javan	
Jawbone	
jawbone	
jaws	
jealous	



ASL Bible Dictionary

Spoken Word	SignWriting
<p>jeirim</p>	<p>The SignWriting for 'jeirim' consists of a sequence of handshapes: a hand with fingers spread and thumb up, followed by a hand with fingers spread and thumb down, then a hand with fingers spread and thumb up, and finally a hand with fingers spread and thumb down.</p>
<p>Jebusites</p>	<p>The SignWriting for 'Jebusites' consists of a sequence of handshapes: a hand with fingers spread and thumb up, followed by a hand with fingers spread and thumb down, then a hand with fingers spread and thumb up, and finally a hand with fingers spread and thumb down.</p>
<p>Jedaiah</p>	<p>The SignWriting for 'Jedaiah' consists of a sequence of handshapes: a hand with fingers spread and thumb up, followed by a hand with fingers spread and thumb down, then a hand with fingers spread and thumb up, and finally a hand with fingers spread and thumb down.</p>

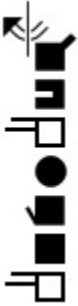

ASL Bible Dictionary

Spoken Word	SignWriting
Jegarsahadutha	 A vertical sequence of 15 SignWriting symbols representing the word 'Jegarsahadutha'. From top to bottom: a hand with fingers spread, a hand with index and middle fingers extended, a hand with index and middle fingers extended, a hand with index and middle fingers extended, a hand with index and middle fingers extended, a hand with index and middle fingers extended, a hand with index and middle fingers extended, a hand with index and middle fingers extended, a hand with index and middle fingers extended, a hand with index and middle fingers extended, a hand with index and middle fingers extended, a hand with index and middle fingers extended, a hand with index and middle fingers extended, a hand with index and middle fingers extended, and a hand with index and middle fingers extended.
Jegarsahadutha	 A vertical sequence of 15 SignWriting symbols representing the word 'Jegarsahadutha'. From top to bottom: a hand with fingers spread, a hand with index and middle fingers extended, a hand with index and middle fingers extended, a hand with index and middle fingers extended, a hand with index and middle fingers extended, a hand with index and middle fingers extended, a hand with index and middle fingers extended, a hand with index and middle fingers extended, a hand with index and middle fingers extended, a hand with index and middle fingers extended, a hand with index and middle fingers extended, a hand with index and middle fingers extended, a hand with index and middle fingers extended, a hand with index and middle fingers extended, and a hand with index and middle fingers extended.



ASL Bible Dictionary

Spoken Word	SignWriting
<p>Jehoash</p>	
<p>Jehohanan</p>	
<p>Jehoiachin</p>	

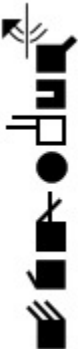

ASL Bible Dictionary

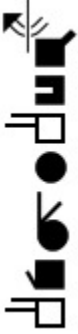
Spoken Word	SignWriting
<p>Jehoiakim</p>	
<p>Jehonathan</p>	
<p>Jehoram</p>	



ASL Bible Dictionary

Spoken Word	SignWriting
<p>Jehoshaphat</p>	
<p>JEHOVAH</p>	
<p>Jehovahjireh</p>	

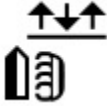

ASL Bible Dictionary

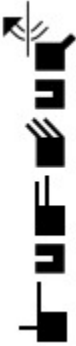
Spoken Word	SignWriting
<p>Jehozadak</p>	 <p>The SignWriting for 'Jehozadak' is a vertical sequence of signs: a hand sign with fingers spread, a 'J' sign, a 'H' sign, a 'Z' sign, a 'D' sign, a 'K' sign, and a 'D' sign.</p>
<p>Jehu</p>	 <p>The SignWriting for 'Jehu' is a vertical sequence of signs: a hand sign with fingers spread, a 'J' sign, and a 'U' sign.</p>
<p>Jekabzeel</p>	 <p>The SignWriting for 'Jekabzeel' is a vertical sequence of signs: a hand sign with fingers spread, a 'J' sign, a 'K' sign, a 'B' sign, a 'Z' sign, and a 'L' sign.</p>
<p>jello</p>	 <p>The SignWriting for 'jello' is a vertical sequence of signs: a hand sign with fingers spread, a 'J' sign, and a 'L' sign.</p>



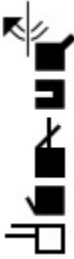
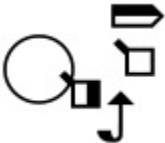

ASL Bible Dictionary

Spoken Word	SignWriting
Jemuel	 The SignWriting for 'Jemuel' is a vertical sequence of seven symbols. From top to bottom: 1. A hand with fingers spread, palm facing left. 2. A hand with fingers spread, palm facing left, with a horizontal line above it. 3. A hand with fingers spread, palm facing left, with a horizontal line above it. 4. A hand with fingers spread, palm facing left, with a horizontal line above it. 5. A hand with fingers spread, palm facing left, with a horizontal line above it. 6. A hand with fingers spread, palm facing left, with a horizontal line above it. 7. A hand with fingers spread, palm facing left, with a horizontal line above it.
Jephthah	 The SignWriting for 'Jephthah' is a vertical sequence of seven symbols. From top to bottom: 1. A hand with fingers spread, palm facing left. 2. A hand with fingers spread, palm facing left, with a horizontal line above it. 3. A hand with fingers spread, palm facing left, with a horizontal line above it. 4. A hand with fingers spread, palm facing left, with a horizontal line above it. 5. A hand with fingers spread, palm facing left, with a horizontal line above it. 6. A hand with fingers spread, palm facing left, with a horizontal line above it. 7. A hand with fingers spread, palm facing left, with a horizontal line above it.



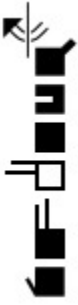

ASL Bible Dictionary

Spoken Word	SignWriting
Jerah	
Jeremiah	
Jeremiah	
Jericho	

ASL Bible Dictionary

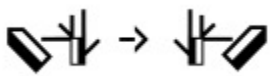
Spoken Word	SignWriting
Jeshaiiah	
Jeshua	
Jesse	
Jesus	
Jesus	

ASL Bible Dictionary

Spoken Word	SignWriting
Jesus	
Jesus	
Jesus	
Jesus relationship	
Jesus-relationship	

ASL Bible Dictionary

Spoken Word	SignWriting
jet	
Jetheth	
Jethro	
Jetur	
Jeush	



ASL Bible Dictionary

Spoken Word	SignWriting
Jew	<p>The signwriting for 'Jew' consists of a circle at the top, followed by a hand with fingers spread, then a hand with fingers spread and a horizontal line, and finally a hand with fingers spread.</p>
Jew	<p>The signwriting for 'Jew' consists of a circle at the top, followed by a hand with fingers spread, then a hand with fingers spread and a horizontal line, and finally a hand with fingers spread.</p>
jewelry	<p>The signwriting for 'jewelry' consists of a hand with fingers spread and a horizontal line, followed by a hand with fingers spread and a horizontal line, and finally a hand with fingers spread and a horizontal line.</p>
Jewish	<p>The signwriting for 'Jewish' consists of a circle at the top, followed by a hand with fingers spread, then a hand with fingers spread and a horizontal line, and finally a hand with fingers spread.</p>
Jewish	<p>The signwriting for 'Jewish' consists of a circle at the top, followed by a hand with fingers spread, then a hand with fingers spread and a horizontal line, and finally a hand with fingers spread.</p>
Jewish	<p>The signwriting for 'Jewish' consists of a circle with a horizontal line inside at the top, followed by a hand with fingers spread, then a hand with fingers spread and a horizontal line, and finally a hand with fingers spread.</p>

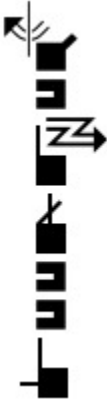
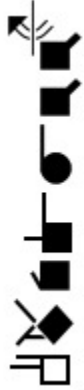

ASL Bible Dictionary

Spoken Word	SignWriting
Jews	<p>The SignWriting for 'Jews' consists of a circle at the top, followed by a hand sign with the index finger pointing up and the thumb pointing right, then a hand sign with the index finger pointing left and the thumb pointing right, and finally a hand sign with the index finger pointing up and the thumb pointing right.</p>
Jezebel	<p>The SignWriting for 'Jezebel' consists of a hand sign with the index finger pointing up and the thumb pointing right, followed by a hand sign with the index finger pointing left and the thumb pointing right, then a hand sign with the index finger pointing up and the thumb pointing right, and finally a hand sign with the index finger pointing up and the thumb pointing right.</p>
Jezer	<p>The SignWriting for 'Jezer' consists of a hand sign with the index finger pointing up and the thumb pointing right, followed by a hand sign with the index finger pointing left and the thumb pointing right, then a hand sign with the index finger pointing up and the thumb pointing right, and finally a hand sign with the index finger pointing up and the thumb pointing right.</p>
Jezrahiah	<p>The SignWriting for 'Jezrahiah' consists of a hand sign with the index finger pointing up and the thumb pointing right, followed by a hand sign with the index finger pointing left and the thumb pointing right, then a hand sign with the index finger pointing up and the thumb pointing right, and finally a hand sign with the index finger pointing up and the thumb pointing right.</p>

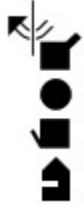

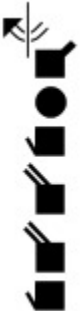
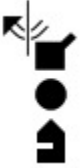

ASL Bible Dictionary

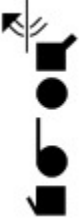
Spoken Word	SignWriting
Jezreel	 <p>The SignWriting for 'Jezreel' consists of a sequence of handshapes and movements. It starts with a handshape for 'J' (index and thumb extended, other fingers curled) with a downward arrow. This is followed by a series of 'Z' shapes (index and thumb extended, other fingers curled) with a downward arrow. The sequence ends with a handshape for 'L' (index and thumb extended, other fingers curled) with a downward arrow.</p>
Jidlaph	 <p>The SignWriting for 'Jidlaph' consists of a sequence of handshapes and movements. It starts with a handshape for 'J' (index and thumb extended, other fingers curled) with a downward arrow. This is followed by a handshape for 'I' (index extended, other fingers curled) with a downward arrow. Next is a handshape for 'D' (index and thumb extended, other fingers curled) with a downward arrow. This is followed by a handshape for 'L' (index and thumb extended, other fingers curled) with a downward arrow. The sequence ends with a handshape for 'P' (index and thumb extended, other fingers curled) with a downward arrow.</p>
Jimnah	 <p>The SignWriting for 'Jimnah' consists of a sequence of handshapes and movements. It starts with a handshape for 'J' (index and thumb extended, other fingers curled) with a downward arrow. This is followed by a handshape for 'I' (index extended, other fingers curled) with a downward arrow. Next is a handshape for 'M' (index and thumb extended, other fingers curled) with a downward arrow. This is followed by a handshape for 'N' (index and thumb extended, other fingers curled) with a downward arrow. The sequence ends with a handshape for 'A' (index and thumb extended, other fingers curled) with a downward arrow.</p>
Joab	 <p>The SignWriting for 'Joab' consists of a sequence of handshapes and movements. It starts with a handshape for 'J' (index and thumb extended, other fingers curled) with a downward arrow. This is followed by a handshape for 'O' (index and thumb extended, other fingers curled) with a downward arrow. Next is a handshape for 'A' (index and thumb extended, other fingers curled) with a downward arrow. The sequence ends with a handshape for 'B' (index and thumb extended, other fingers curled) with a downward arrow.</p>



ASL Bible Dictionary

Spoken Word	SignWriting
Joanan	
Joanna	
Job	
Jobab	
Joda	

ASL Bible Dictionary

Spoken Word	SignWriting
Joed	
Joel	
Johanan	
John	
John 6:18 corrected	
John D.	

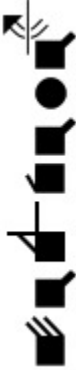
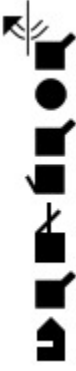

ASL Bible Dictionary

Spoken Word	SignWriting
Joiada	
Joiakim	
Joiarib	
join	
join	

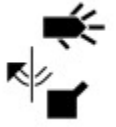

ASL Bible Dictionary

Spoken Word	SignWriting
join-me	<p>The signwriting for 'join-me' consists of a circle with a downward arrow above it and an upward arrow below it. To the right of the circle is a hand icon with an arrow pointing towards it, and another hand icon with an arrow pointing away from it, suggesting a joining action.</p>
joint	<p>The signwriting for 'joint' is a vertical sequence of five symbols: a hand with an arrow pointing up and to the right, a solid black circle, a hand with an arrow pointing up and to the right, a hand with an arrow pointing up and to the right, and a solid black square.</p>
jokes	<p>The signwriting for 'jokes' is a vertical sequence of four symbols: two upward-pointing arrows, a hand with an arrow pointing up and to the right, and a solid black square.</p>
Jokshan	<p>The signwriting for 'Jokshan' is a vertical sequence of six symbols: a hand with an arrow pointing up and to the right, a solid black circle, a hand with an arrow pointing up and to the right, a hand with an arrow pointing up and to the right, a hand with an arrow pointing up and to the right, and a solid black square.</p>
Joktan	<p>The signwriting for 'Joktan' is a vertical sequence of six symbols: a hand with an arrow pointing up and to the right, a solid black circle, a hand with an arrow pointing up and to the right, a hand with an arrow pointing up and to the right, a hand with an arrow pointing up and to the right, and a solid black square.</p>



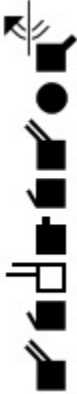

ASL Bible Dictionary

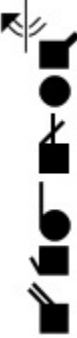
Spoken Word	SignWriting
Jonah	
Jonah	
Jonah	
Jonah01v01 NLT	
JonahBio01	
JonahBio02E	
JonahBio03E	
JonahBio04E	
JonahBio05A	
JonahBio06E	
JonahBio07	
JonahBio08E	
Jonam	

ASL Bible Dictionary

Spoken Word	SignWriting
Jonathan	
Joppa	
Jorah	
Jordan	





ASL Bible Dictionary

Spoken Word	SignWriting
Jorim	
Josech	
Joseph	
Joshua	
Joshua	

ASL Bible Dictionary

Spoken Word	SignWriting
joy	
joyful	
joyful	
joys	
Jozabad	

ASL Bible Dictionary

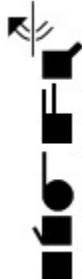
Spoken Word	SignWriting
Jr.	
Jubal	
Judah	
Judaism	
Judas	



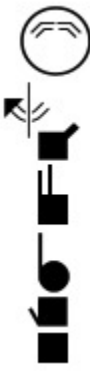
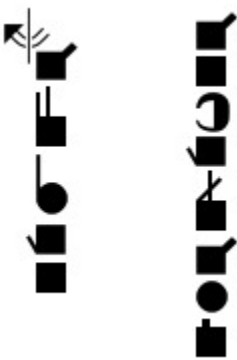
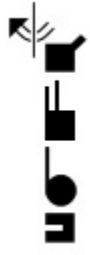
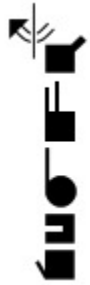

ASL Bible Dictionary

Spoken Word	SignWriting
Judas	
Judas-Iscaariot	
Jude	
Judea	

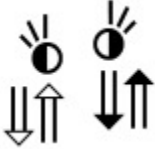
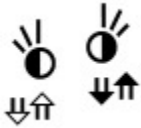

ASL Bible Dictionary

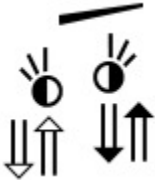
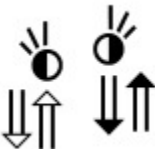
Spoken Word	SignWriting
Judean	 The SignWriting for 'Judean' is a vertical sequence of seven symbols. From top to bottom: 1. A hand with fingers spread, palm facing left. 2. A square with a horizontal line through its center. 3. A square with a horizontal line through its center. 4. A square with a horizontal line through its center. 5. A circle with a horizontal line through its center. 6. A square with a horizontal line through its center. 7. A square with a horizontal line through its center.

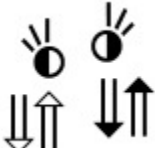

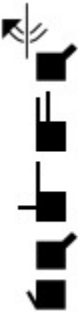
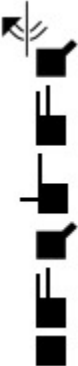

ASL Bible Dictionary

Spoken Word	SignWriting
judge	
judge	
judge	
judge	
judgement	
Judges	
judgment	



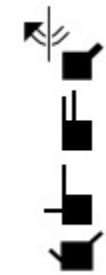

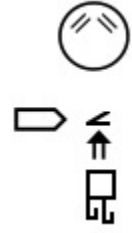
ASL Bible Dictionary

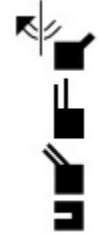
Spoken Word	SignWriting
Judith	
Judy	
juice	
Julia	
Julius	

ASL Bible Dictionary

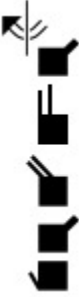
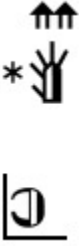
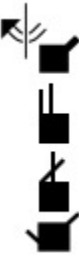
Spoken Word	SignWriting
July	
jump	
jump	
jump	
jumping	
June	



ASL Bible Dictionary

Spoken Word	SignWriting
Junia	
jurisdiction	
jury	
just	
just	
just	
justice	





ASL Bible Dictionary

Spoken Word	SignWriting
justify	<p>The SignWriting for 'justify' consists of two parts. The first part is a vertical sequence of four squares: the top two are empty, and the bottom two are filled. The second part is a hand symbol with the index finger pointing up and the thumb pointing right, with two asterisks to its right, indicating a specific hand movement.</p>
Justus	<p>The SignWriting for 'Justus' starts with a hand symbol (index up, thumb right) with two asterisks. This is followed by a vertical sequence of seven squares: the top one is empty, and the remaining six are filled.</p>
juvenile	<p>The SignWriting for 'juvenile' begins with a hand symbol (index up, thumb right) with two asterisks. This is followed by a vertical sequence of seven squares: the top one is empty, and the remaining six are filled. Below these squares is a vertical sequence of four hand symbols: the first has index up and thumb right; the second has index up and thumb left; the third has index up and thumb right; and the fourth has index up and thumb left.</p>
jv	<p>The SignWriting for 'jv' starts with a hand symbol (index up, thumb right) with two asterisks, followed by a vertical sequence of two squares: the top one is empty and the bottom one is filled. Below these is a vertical sequence of two hand symbols: the first has index up and thumb right, and the second has index up and thumb left.</p>
K	<p>The SignWriting for 'K' is a single hand symbol with the index finger pointing up and the thumb pointing right.</p>





ASL Bible Dictionary

Spoken Word	SignWriting
Kadesh	
Kadmiel	
Kadmiel	

ASL Bible Dictionary

Spoken Word	SignWriting
Kadmonites	
Kallai	
Kandake	
karate	





ASL Bible Dictionary

Spoken Word	SignWriting
Karnaim	
Kate	
Kedar	
Kedemah	
keel	



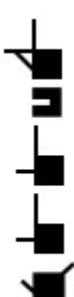

ASL Bible Dictionary

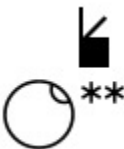
Spoken Word	SignWriting
keel	<p>The signwriting for 'keel' consists of three parts: a circle with two horizontal lines inside, a diamond shape with two lines extending from its top corners, and a hand with fingers spread, with a downward arrow below it.</p>
keep	<p>The signwriting for 'keep' is a diamond shape with two lines extending from its top corners, with a downward arrow above it.</p>
keep	<p>The signwriting for 'keep' is a hand with fingers spread, with a downward arrow above it.</p>
keep	<p>The signwriting for 'keep' is a circle with a wavy line inside, with a hand with fingers spread below it.</p>
keep	<p>The signwriting for 'keep' is a circle with two horizontal lines inside, with a hand with fingers spread below it.</p>
keeper	<p>The signwriting for 'keeper' consists of a diamond shape with two lines extending from its top corners, a hand with fingers spread, and two hands with fingers spread, each with a downward arrow below it.</p>



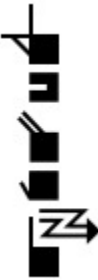

ASL Bible Dictionary

Spoken Word	SignWriting
Keilah	
Kelita	
Kelly	
Kemuel	
Ken	
Ken	

ASL Bible Dictionary

Spoken Word	SignWriting
Kenan	
Kenani	
Kenaz	
Kendall	







ASL Bible Dictionary

Spoken Word	SignWriting
Kenites	
Kenizzites	
Kephirah	
Keros	

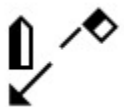
ASL Bible Dictionary

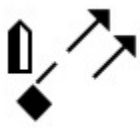
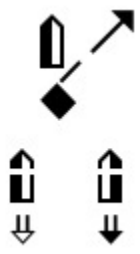
Spoken Word	SignWriting
keys	
kidney	
Kidron	
kilion	
kill	
kill	





ASL Bible Dictionary

Spoken Word	SignWriting
kill	
kill	
kill	
killer	
kills	
kilograms	
kind	

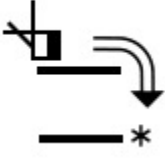

ASL Bible Dictionary

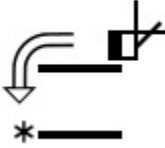
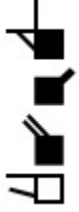
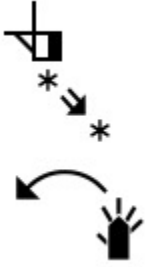
Spoken Word	SignWriting
kind	<p>The signwriting for 'kind' consists of a circular arrow pointing clockwise, followed by a handshape with the index finger pointing up and the thumb pointing right, and another handshape with the index finger pointing down and the thumb pointing right.</p>
kind-of	<p>The signwriting for 'kind-of' consists of a circular arrow pointing clockwise, followed by a handshape with the index finger pointing up and the thumb pointing right, and another handshape with the index finger pointing down and the thumb pointing right.</p>
kindness	<p>The signwriting for 'kindness' consists of a circular arrow pointing clockwise, followed by a handshape with the index finger pointing up and the thumb pointing right, and another handshape with the index finger pointing down and the thumb pointing right.</p>
kindness	<p>The signwriting for 'kindness' consists of a handshape with the index finger pointing up and the thumb pointing right, followed by a circular arrow pointing clockwise.</p>
king	<p>The signwriting for 'king' consists of a handshape with the index finger pointing up and the thumb pointing right, followed by an arrow pointing down and to the right, and another arrow pointing down and to the right with a small asterisk next to it.</p>
king	<p>The signwriting for 'king' consists of a circular arrow pointing clockwise, followed by a handshape with the index finger pointing up and the thumb pointing right, and another handshape with the index finger pointing down and the thumb pointing right with a small asterisk next to it.</p>
king	<p>The signwriting for 'king' consists of a handshape with the index finger pointing up and the thumb pointing right, followed by an arrow pointing down and to the right, and another arrow pointing down and to the right with a small asterisk next to it.</p>
king	<p>The signwriting for 'king' consists of a handshape with the index finger pointing up and the thumb pointing right, followed by an arrow pointing down and to the right, and another arrow pointing down and to the right with a small asterisk next to it.</p>
king	<p>The signwriting for 'king' consists of a handshape with the index finger pointing up and the thumb pointing right, followed by an arrow pointing down and to the right, and another arrow pointing down and to the right with a small asterisk next to it.</p>

ASL Bible Dictionary

Spoken Word	SignWriting
king	
king	
king	
king	
kingdom	
kingdoms	

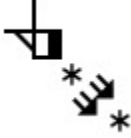

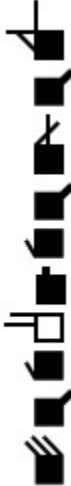



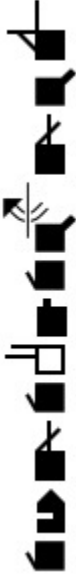

ASL Bible Dictionary

Spoken Word	SignWriting
Kings	
kings	
Kios	
Kiriath	
Kiriathaim	

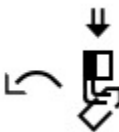

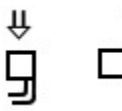



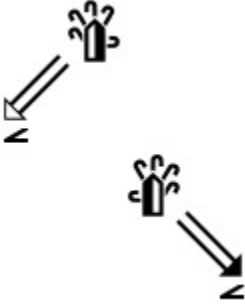

ASL Bible Dictionary

Spoken Word	SignWriting
Kirjatharba	 A vertical sequence of ten SignWriting symbols representing the word 'Kirjatharba'. From top to bottom: 1. A square with a vertical line extending upwards from its top center. 2. A square with a vertical line extending upwards from its top center. 3. A square with a vertical line extending upwards from its top center. 4. A square with a vertical line extending upwards from its top center, and a small arrow pointing to the left from the top left corner. 5. A square with a vertical line extending upwards from its top center. 6. A square with a vertical line extending upwards from its top center. 7. A square with a vertical line extending upwards from its top center. 8. A square with a vertical line extending upwards from its top center. 9. A square with a vertical line extending upwards from its top center. 10. A square with a vertical line extending upwards from its top center.







ASL Bible Dictionary

Spoken Word	SignWriting
knead	
kneel	
kneel	
kneel	
kneel	
kneel	
knees	
knife	
knock	



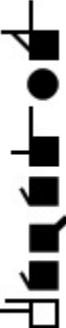

ASL Bible Dictionary

Spoken Word	SignWriting
knock	
knock-over	
know	
know	
know	
know	
know	
know-that	
know-that	







ASL Bible Dictionary

Spoken Word	SignWriting
knowledge	
knows	
knows	
knows	
Kohath	
Kolaiah	
Korah	

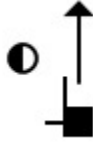

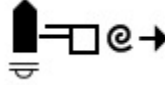



ASL Bible Dictionary

Spoken Word	SignWriting
Korazin	 <p>The SignWriting for 'Korazin' consists of a sequence of handshapes: a hand with fingers spread, a hand with fingers spread and thumb up, a hand with fingers spread and thumb up, a hand with fingers spread and thumb up, a hand with fingers spread and thumb up, a hand with fingers spread and thumb up, a hand with fingers spread and thumb up, a hand with fingers spread and thumb up, a hand with fingers spread and thumb up, and a hand with fingers spread and thumb up.</p>
koum	 <p>The SignWriting for 'koum' consists of a sequence of handshapes: a hand with fingers spread, a hand with fingers spread and thumb up, a hand with fingers spread and thumb up, and a hand with fingers spread and thumb up.</p>
Kris	 <p>The SignWriting for 'Kris' consists of a sequence of handshapes: a hand with fingers spread, a hand with fingers spread and thumb up, a hand with fingers spread and thumb up, and a hand with fingers spread and thumb up.</p>
L	 <p>The SignWriting for 'L' consists of a single handshape: a hand with fingers spread and thumb up.</p>
l'Action	 <p>The SignWriting for 'l'Action' consists of a sequence of handshapes: a hand with fingers spread, a hand with fingers spread and thumb up, a hand with fingers spread and thumb up, a hand with fingers spread and thumb up, a hand with fingers spread and thumb up, a hand with fingers spread and thumb up, a hand with fingers spread and thumb up, a hand with fingers spread and thumb up, a hand with fingers spread and thumb up, and a hand with fingers spread and thumb up.</p>

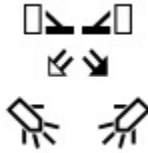

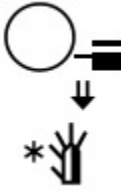
ASL Bible Dictionary

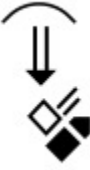
Spoken Word	SignWriting
L-pass-O	
Laban	
label	
labor	
Labs	
Lachish	





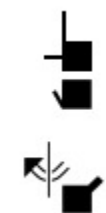
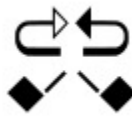
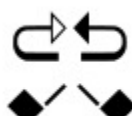

ASL Bible Dictionary

Spoken Word	SignWriting
lack	
ladder	
lady	
Lahairoi	
laid	
laid-to-rest	
laid-up	

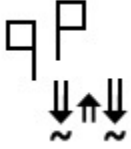





ASL Bible Dictionary

Spoken Word	SignWriting
LaJolla	 <p>The SignWriting for 'LaJolla' consists of a vertical sequence of five signs: a square with a horizontal line above it, a square with a horizontal line above it and a hand symbol to the left, a square with a horizontal line above it and a circle to the right, a square with a horizontal line above it, and another square with a horizontal line above it.</p>
LaJolla	 <p>The SignWriting for 'LaJolla' consists of a vertical sequence of two signs: a square with a horizontal line above it, and a square with a horizontal line above it and a hand symbol to the left.</p>
lake	 <p>The SignWriting for 'lake' consists of two diamond shapes at the bottom, with two curved arrows above them that form a circular path between the diamonds.</p>
lake	 <p>The SignWriting for 'lake' consists of two diamond shapes at the bottom, with two curved arrows above them that form a circular path between the diamonds.</p>
lamb	 <p>The SignWriting for 'lamb' consists of two parts: the top part shows a square with a horizontal line above it, a hand symbol to the left, and a hand symbol to the right; the bottom part shows two hand symbols, one on the left and one on the right, both with fingers spread.</p>
lambs	 <p>The SignWriting for 'lambs' consists of two parts: the top part shows a square with a horizontal line above it, a hand symbol to the left, and a hand symbol to the right; the bottom part shows two hand symbols, one on the left and one on the right, both with fingers spread.</p>

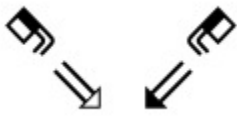

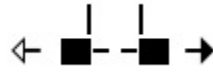

ASL Bible Dictionary

Spoken Word	SignWriting
lame	
lame	
Lamech	
lamp	
lamp	
land	
land	





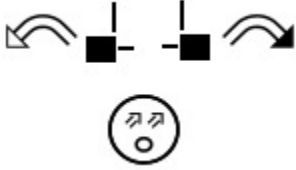
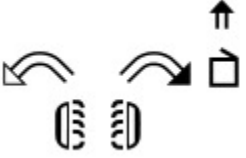

ASL Bible Dictionary

Spoken Word	SignWriting
land	
land	
language	
language	
languages	
lantern	

ASL Bible Dictionary

Spoken Word	SignWriting
Laodicea	
lap	
lap	
lap	
large	
large	
larger	

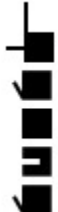

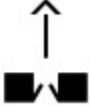



ASL Bible Dictionary

Spoken Word	SignWriting
larger-sense	
largest	
Larry	
Lars	
Lasea	
Lasha	
last	





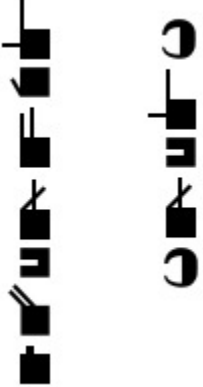



ASL Bible Dictionary

Spoken Word	SignWriting
last	<p>The signwriting for 'last' consists of two diamond shapes. The first diamond is positioned above the second. A downward-pointing arrow is located between the two diamonds, pointing towards the second diamond.</p>
last-year	<p>The signwriting for 'last-year' is composed of two parts. The upper part features a downward-pointing arrow above a vertical line with three small squares stacked on its left side. The lower part consists of a horizontal line with a small square to its right, and a downward-pointing arrow positioned below the square.</p>
lastly	<p>The signwriting for 'lastly' includes a circle with two parallel diagonal lines inside, positioned above the 'last' signwriting (two diamonds with a downward arrow between them).</p>
late	<p>The signwriting for 'late' features a horizontal line above another horizontal line. To the right of the second line is a diamond shape with a downward-pointing arrow below it.</p>
later	<p>The signwriting for 'later' starts with a circle containing two parallel diagonal lines. Below this are three distinct symbols: a vertical line with a small square to its left, a horizontal line with a small square to its right, and a hook-like symbol.</p>
later	<p>The signwriting for 'later' consists of three vertically stacked symbols: a horizontal line with a small square to its right, a hook-like symbol, and another horizontal line with a small square to its right.</p>
later	<p>The signwriting for 'later' shows a vertical line with a small square to its left, followed by a horizontal line with a small square to its right, and a downward-pointing arrow below the second square.</p>
later	<p>The signwriting for 'later' includes a circle with two parallel diagonal lines, followed by a vertical line with a small square to its left, a horizontal line with a small square to its right, and a hook-like symbol.</p>

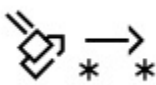

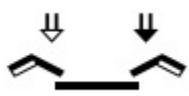
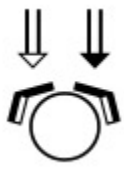

ASL Bible Dictionary

Spoken Word	SignWriting
Latin	
laugh	
launch	
Laurent-Clerc	
Laurent-Clerc	
law	



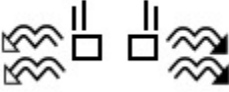
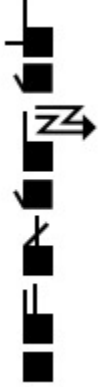
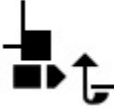

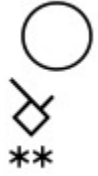



ASL Bible Dictionary

Spoken Word	SignWriting
lawyer	
lay	
lay	
lay down	
lay down	
lay-down	
lay-hands	
lay-hands	
lay-hands	

ASL Bible Dictionary

Spoken Word	SignWriting
lay-on-porch	
Lazarus	
Lazarus	
Lazarus	
lazy	
lazy	
lead	



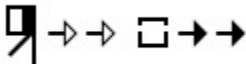

ASL Bible Dictionary

Spoken Word	SignWriting
lead	
lead	
lead	
lead	
lead	
lead	
lead	
lead	
lead	
lead	







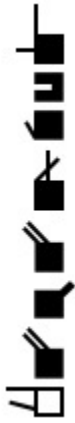

ASL Bible Dictionary

Spoken Word	SignWriting
leader	<p>The signwriting for 'leader' consists of three parts: a diagonal line with an arrow pointing up and to the right, and two vertical lines below it, each with a downward-pointing arrow.</p>
leaders	<p>The signwriting for 'leaders' consists of three parts: a diagonal line with an arrow pointing up and to the right, and two vertical lines below it, each with a downward-pointing arrow and a rightward-pointing arrow.</p>
leaders	<p>The signwriting for 'leaders' consists of three parts: a horizontal line with an arrow pointing right, followed by a vertical line with a downward-pointing arrow, and two vertical lines below it, each with a downward-pointing arrow and a rightward-pointing arrow.</p>
leaf	<p>The signwriting for 'leaf' consists of three parts: a horizontal line with two upward-pointing arrows, a hand icon with fingers spread, and a diamond shape below it.</p>
league	<p>The signwriting for 'league' consists of a vertical line with a horizontal line at the top, followed by a series of horizontal lines of varying lengths, and a vertical line at the bottom.</p>
Leah	<p>The signwriting for 'Leah' consists of a vertical line with a horizontal line at the top, followed by a series of horizontal lines of varying lengths, and a vertical line at the bottom.</p>







ASL Bible Dictionary

Spoken Word	SignWriting
leak	
lean	
leap	
learn	
learn	
learning	

ASL Bible Dictionary

Spoken Word	SignWriting
lease	
least	
least	
leather	
leave	
leave	
leave	
leave	
leave	

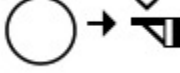



ASL Bible Dictionary

Spoken Word	SignWriting
leave	
leave	
leaven	
leaves	
leaving	
Lebanah	

ASL Bible Dictionary

Spoken Word	SignWriting
leg	<p>The SignWriting for 'leg' consists of two parts. The first part is a circle with two short horizontal lines inside, representing the letter 'L'. The second part is a hand symbol with two asterisks below it, representing the letter 'G'.</p>
legal	<p>The SignWriting for 'legal' consists of a house symbol, followed by a hand symbol with two asterisks below it, and then a hand symbol with a downward-pointing arrow below it.</p>
Legion	<p>The SignWriting for 'Legion' is a vertical sequence of symbols: a hand symbol with a horizontal line above it, followed by a hand symbol with a horizontal line above it, then a hand symbol with a horizontal line above it, a solid circle, and finally a hand symbol with a horizontal line above it.</p>
Legion	<p>The SignWriting for 'Legion' is a vertical sequence of symbols: a hand symbol with a horizontal line above it, followed by a hand symbol with a horizontal line above it, then a hand symbol with a horizontal line above it, a solid circle, and finally a hand symbol with a horizontal line above it.</p>
legs	<p>The SignWriting for 'legs' is a vertical sequence of symbols: a hand symbol with a horizontal line above it, followed by a hand symbol with a horizontal line above it, and then a hand symbol with a horizontal line above it.</p>
Lehabim	<p>The SignWriting for 'Lehabim' is a vertical sequence of symbols: a hand symbol with a horizontal line above it, followed by a hand symbol with a horizontal line above it, then a hand symbol with a horizontal line above it, a hand symbol with a horizontal line above it, a hand symbol with a horizontal line above it, a hand symbol with a horizontal line above it, and finally a hand symbol with a horizontal line above it.</p>

ASL Bible Dictionary

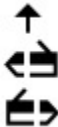
Spoken Word	SignWriting
Lehi	
Leith	
lema	
Lemuel	
length	

ASL Bible Dictionary

Spoken Word	SignWriting
lentiles	<p>The SignWriting for 'lentiles' consists of a vertical sequence of symbols: a horizontal line, a square with a vertical line on its right side, a square with a diagonal line from top-left to bottom-right, a square with a vertical line on its right side, a square with a diagonal line from top-left to bottom-right, a square with a vertical line on its right side, a horizontal line, a square with a vertical line on its right side, a square with a diagonal line from top-left to bottom-right, a square with a vertical line on its right side, and a square with a diagonal line from top-left to bottom-right.</p>
leopard	<p>The SignWriting for 'leopard' consists of a vertical sequence of symbols: a horizontal line, a square with a vertical line on its right side, a square with a diagonal line from top-left to bottom-right, a diamond shape, a square with a diagonal line from top-left to bottom-right, a square with a vertical line on its right side, a square with a diagonal line from top-left to bottom-right, a horizontal line, and a solid circle.</p>
leper	<p>The SignWriting for 'leper' consists of a vertical sequence of symbols: a horizontal line, a square with a vertical line on its right side, a square with a vertical line on its right side, a horizontal line, a square with a vertical line on its right side, a square with a diagonal line from top-left to bottom-right, a square with a vertical line on its right side, and a square with a diagonal line from top-left to bottom-right.</p>
leper	<p>The SignWriting for 'leper' consists of a vertical sequence of symbols: a hand with fingers spread, a hand with fingers spread, a circle with a hand on its right side, a hand with fingers spread, an asterisk, a hand with fingers spread, and a hand with fingers spread.</p>

ASL Bible Dictionary

Spoken Word	SignWriting
lepers	<p>The SignWriting for 'lepers' consists of three distinct signs. The first sign is a hand with fingers spread, palm facing left, positioned above a solid black rectangle. The second sign is a hand with fingers spread, palm facing left, positioned above a circle. The third sign is a hand with fingers spread, palm facing left, positioned above an asterisk.</p>
leprosy	<p>The SignWriting for 'leprosy' consists of three distinct signs. The first sign is a hand with fingers spread, palm facing left, positioned above a solid black rectangle. The second sign is a hand with fingers spread, palm facing left, positioned above a circle. The third sign is a hand with fingers spread, palm facing left, positioned above an asterisk.</p>
leprosy	<p>The SignWriting for 'leprosy' consists of a vertical sequence of five signs. From top to bottom: a hand with fingers spread, palm facing left, positioned above a solid black rectangle; a hand with fingers spread, palm facing left, positioned above a diamond; a hand with fingers spread, palm facing left, positioned above a solid black circle; a hand with fingers spread, palm facing left, positioned above a solid black square; and a hand with fingers spread, palm facing left, positioned above a solid black rectangle.</p>
leprous	<p>The SignWriting for 'leprous' consists of two distinct signs. The first sign is a hand with fingers spread, palm facing left, positioned above a solid black rectangle and an asterisk. The second sign is a hand with fingers spread, palm facing left, positioned above a circle and an asterisk.</p>



ASL Bible Dictionary

Spoken Word	SignWriting
less	<p>The signwriting for 'less' consists of a downward arrow above a horizontal line, followed by a square with a left-pointing arrow, and a square with a right-pointing arrow below it.</p>
less-less	<p>The signwriting for 'less-less' consists of a diamond shape with a downward arrow, followed by a horizontal line with a downward arrow, and a square with a right-pointing arrow below it.</p>
less-than	<p>The signwriting for 'less-than' consists of a square with a right-pointing arrow, followed by a square with a downward arrow, and a square with a right-pointing arrow below it.</p>
less-than	<p>The signwriting for 'less-than' consists of a diamond shape with a downward arrow, followed by a square with a right-pointing arrow, and a square with a downward arrow below it.</p>
lesson	<p>The signwriting for 'lesson' consists of two asterisks on the left, followed by a house-like shape with a right-pointing arrow.</p>
lesson	<p>The signwriting for 'lesson' consists of two asterisks on the left, followed by a house-like shape with a right-pointing arrow, and a square with a right-pointing arrow to its right.</p>
lessons	<p>The signwriting for 'lessons' consists of two asterisks on the left, followed by a house-like shape with a right-pointing arrow.</p>
let	<p>The signwriting for 'let' consists of a circle with a downward arrow and an upward arrow above it, followed by a horizontal line, and two vertical arrows pointing up below it.</p>
let	<p>The signwriting for 'let' consists of a circle with a downward arrow and an upward arrow above it, followed by two vertical arrows pointing up below it.</p>

ASL Bible Dictionary

Spoken Word	SignWriting
let	<p>The SignWriting for 'let' consists of a circle with a downward arrow above it and an upward arrow below it. Below this circle is a diagonal line. Underneath the diagonal line are two upward-pointing arrows, one on the left and one on the right.</p>
let-go	<p>The SignWriting for 'let-go' shows two hands. The left hand is open with fingers spread. The right hand is in a fist with the thumb pointing left, indicating a release or letting go.</p>
letter	<p>The SignWriting for 'letter' features a circle at the top, connected by a vertical line to a square. Below the square is a downward-pointing arrow. At the bottom is a hand icon with the index finger pointing down.</p>
letters	<p>The SignWriting for 'letters' is similar to 'letter', but the downward-pointing arrow below the square is replaced by three horizontal arrows pointing to the left.</p>
lettuce	<p>The SignWriting for 'lettuce' shows a circle on the left. To its right is a hand icon with the index finger pointing left, and another hand icon below it with the index finger pointing left.</p>
Letushim	<p>The SignWriting for 'Letushim' is a vertical sequence of symbols: a horizontal line at the top, followed by a square, a hand icon with the index finger pointing down, another square, a horizontal line, another square, a horizontal line, another square, and finally a hand icon with the index finger pointing down.</p>

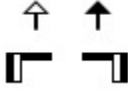
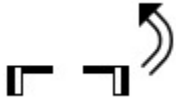
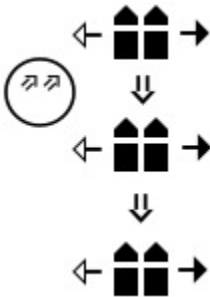
ASL Bible Dictionary

Spoken Word	SignWriting
Leummim	
level	
level	
levels	
Levi	







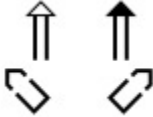

ASL Bible Dictionary

Spoken Word	SignWriting
Levite	<p>The SignWriting for 'Levite' consists of a vertical line of signs. From top to bottom: a horizontal line with a downward arrow, a vertical line with a rightward arrow, a vertical line with a leftward arrow, a vertical line with a rightward arrow, a vertical line with a leftward arrow, a vertical line with a rightward arrow, and a vertical line with a leftward arrow.</p>
Levites	<p>The SignWriting for 'Levites' is identical to 'Levite', consisting of a vertical line of signs: a horizontal line with a downward arrow, followed by alternating vertical lines with rightward and leftward arrows.</p>
Lewis	<p>The SignWriting for 'Lewis' consists of a vertical line of signs. From top to bottom: a horizontal line with a downward arrow, a vertical line with a rightward arrow, a vertical line with a leftward arrow, a vertical line with a rightward arrow, a vertical line with a leftward arrow, a vertical line with a rightward arrow, a vertical line with a leftward arrow, a vertical line with a rightward arrow, and a vertical line with a leftward arrow.</p>
liar	<p>The SignWriting for 'liar' consists of a vertical line of signs. From top to bottom: a circle with a horizontal line through its center and an arrow pointing left, a vertical line with a rightward arrow, a vertical line with a leftward arrow, a vertical line with a rightward arrow, and a vertical line with a leftward arrow.</p>
liars	<p>The SignWriting for 'liars' consists of a vertical line of signs. From top to bottom: a circle with a horizontal line through its center and an arrow pointing left, a vertical line with a rightward arrow, a vertical line with a leftward arrow, a vertical line with a rightward arrow, a vertical line with a leftward arrow, a vertical line with a rightward arrow, and a vertical line with a leftward arrow.</p>

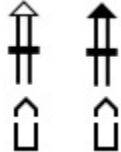





ASL Bible Dictionary

Spoken Word	SignWriting
liberty	<p>The sign for 'liberty' is composed of three main parts: a left hand starting with the index finger pointing up and moving in a counter-clockwise circle, a central hand starting with the index finger pointing up and moving in a clockwise circle, and a right hand starting with the index finger pointing up and moving in a counter-clockwise circle.</p>
librarian	<p>The sign for 'librarian' consists of three distinct hand movements: first, a hand starting with the index finger pointing up and moving in a counter-clockwise circle; second, a hand starting with the index finger pointing up and moving in a clockwise circle; and third, a hand starting with the index finger pointing up and moving in a counter-clockwise circle.</p>
library	<p>The sign for 'library' is a single hand movement starting with the index finger pointing up and moving in a counter-clockwise circle.</p>
Libya	<p>The sign for 'Libya' is a vertical sequence of five hand movements, each starting with the index finger pointing up and moving in a counter-clockwise circle.</p>
license	<p>The sign for 'license' consists of three hand movements: a hand starting with the index finger pointing up and moving in a counter-clockwise circle, followed by a hand starting with the index finger pointing up and moving in a clockwise circle, and finally a hand starting with the index finger pointing up and moving in a counter-clockwise circle.</p>
lie	<p>The sign for 'lie' is a single hand movement starting with the index finger pointing up and moving in a counter-clockwise circle.</p>
Lie	<p>The sign for 'Lie' consists of three hand movements: a hand starting with the index finger pointing up and moving in a counter-clockwise circle, followed by a hand starting with the index finger pointing up and moving in a clockwise circle, and finally a hand starting with the index finger pointing up and moving in a counter-clockwise circle.</p>
lie	<p>The sign for 'lie' is a single hand movement starting with the index finger pointing up and moving in a counter-clockwise circle.</p>
lies	<p>The sign for 'lies' is a single hand movement starting with the index finger pointing up and moving in a counter-clockwise circle.</p>

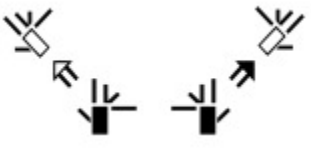
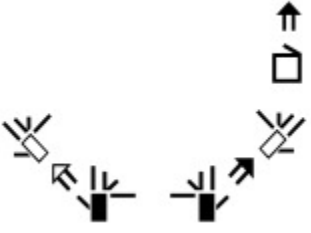

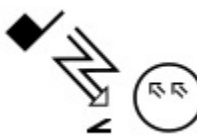

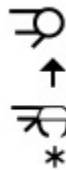
ASL Bible Dictionary

Spoken Word	SignWriting
lift hands	
lift head	
lift-arms	
lift-head	
lift-up	
lifted-up	
light	
light	



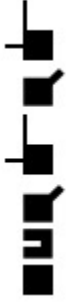

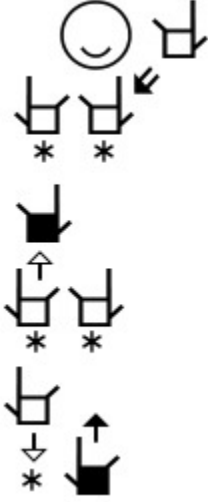



ASL Bible Dictionary

Spoken Word	SignWriting
light	
lighter	
lightning	
lightning	
like	
like	
like	
like	

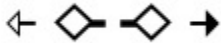
ASL Bible Dictionary

Spoken Word	SignWriting
lilies	 The signwriting for 'lilies' consists of a vertical sequence of six symbols. From top to bottom: a horizontal line, a square with a vertical line on its right side, a square with a vertical line on its right side and a diagonal line from top-left to bottom-right, a horizontal line, a square with a vertical line on its right side, and a solid black square.
lily	 The signwriting for 'lily' consists of a vertical sequence of five symbols. From top to bottom: a horizontal line, a square with a vertical line on its right side, a square with a vertical line on its right side and a diagonal line from top-left to bottom-right, a horizontal line, and a square with a vertical line on its right side.
LIM	 The signwriting for 'LIM' is a vertical sequence of nine symbols. From top to bottom: a circle with a horizontal line through its center, a square with a vertical line on its right side and a diagonal line from top-left to bottom-right, a square with a vertical line on its right side and a diagonal line from top-left to bottom-right, a square with a vertical line on its right side and a diagonal line from top-left to bottom-right, a solid black square, a square with a vertical line on its right side and a horizontal line above it, a square with a vertical line on its right side and a horizontal line above it, a square with a vertical line on its right side and a horizontal line above it, and a square with a vertical line on its right side and a horizontal line above it.
Lincoln	 The signwriting for 'Lincoln' consists of a vertical sequence of seven symbols. From top to bottom: a horizontal line, a square with a vertical line on its right side, a square with a vertical line on its right side and a diagonal line from top-left to bottom-right, a square with a vertical line on its right side and a diagonal line from top-left to bottom-right, a solid black circle, a square with a vertical line on its right side, and a square with a vertical line on its right side.







ASL Bible Dictionary

Spoken Word	SignWriting
Lincoln	
Linda	
line	
line	
line	
line	
line	
line-fish	









ASL Bible Dictionary

Spoken Word	SignWriting
<p>linen</p>	
<p>linguistics</p>	
<p>Linstok</p>	
<p>Linus</p>	
<p>lion</p>	
<p>lioness</p>	





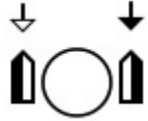

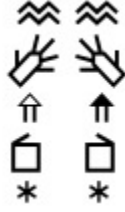

ASL Bible Dictionary

Spoken Word	SignWriting
lions	
lipread	
Lisa	
Lisbon	
List	
list	
list	

ASL Bible Dictionary

Spoken Word	SignWriting
list	
list	
list	
list	
listen	
listen	
listen	
listen	
listen	
literature	

ASL Bible Dictionary

Spoken Word	SignWriting
living	
living	
LLCN	
lo	
loan	
loan	
loan	
loans	

ASL Bible Dictionary

Spoken Word	SignWriting
loaves	<p>The signwriting for 'loaves' consists of two parts. The first part shows a hand with fingers spread, moving from left to right, with a downward arrow below it. The second part shows a hand with the index finger pointing up, moving from left to right, with a downward arrow below it.</p>
lobby	<p>The signwriting for 'lobby' is a vertical sequence of symbols: a horizontal line with a downward arrow, a circle with a downward arrow, a hand with fingers spread, a hand with the index finger pointing up, and a hand with the index finger pointing down.</p>
lobby	<p>The signwriting for 'lobby' is a vertical sequence of symbols: a horizontal line with a downward arrow, a circle with a downward arrow, a hand with fingers spread, a hand with the index finger pointing up, and a hand with the index finger pointing down.</p>
lock	<p>The signwriting for 'lock' is a vertical sequence of symbols: a hand with fingers spread, a hand with the index finger pointing up, and a hand with the index finger pointing down.</p>
lock	<p>The signwriting for 'lock' is a vertical sequence of symbols: a hand with the index finger pointing up, a hand with the index finger pointing down, and a hand with the index finger pointing up.</p>
locusts	<p>The signwriting for 'locusts' is a vertical sequence of symbols: a hand with the index finger pointing up, a hand with the index finger pointing down, a hand with the index finger pointing up, a hand with the index finger pointing down, and a hand with the index finger pointing up.</p>







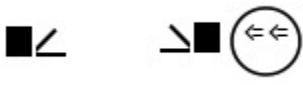

ASL Bible Dictionary

Spoken Word	SignWriting
locusts	<p>The SignWriting for 'locusts' consists of a vertical sequence of symbols: a horizontal line with a vertical tick on the right, a square, a circle, a crescent moon, a horizontal line with a vertical tick on the right, a square, a square, a square, and a square.</p>
Lod	<p>The SignWriting for 'Lod' consists of a vertical sequence of symbols: a horizontal line with a vertical tick on the right, a square, a circle, and a circle.</p>
log	<p>The SignWriting for 'log' consists of a central symbol of a hand holding a log, with two arrows pointing away from it. Below this are two identical symbols, each consisting of a square with a horizontal line above it and a downward-pointing arrow.</p>
Lois	<p>The SignWriting for 'Lois' consists of a vertical sequence of symbols: a horizontal line with a vertical tick on the right, a square, a circle, a square, and a square.</p>
long	<p>The SignWriting for 'long' consists of a hand with fingers extended, a circle with a dot inside, and a square.</p>
long-ago	<p>The SignWriting for 'long-ago' consists of a circle, a hand with fingers extended, a hand with fingers extended, and a hand with fingers extended.</p>

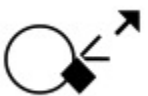



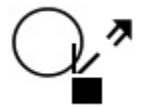
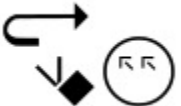

ASL Bible Dictionary

Spoken Word	SignWriting
long-ago	<p>The SignWriting for 'long-ago' consists of a circle on the left, followed by a vertical line with a downward arrow, a hand with fingers spread, and another vertical line with a downward arrow.</p>
long-ago	<p>The SignWriting for 'long-ago' consists of a circle on the left, followed by a vertical line with a downward arrow, and a hand with fingers spread.</p>
long-range	<p>The SignWriting for 'long-range' consists of a hand with fingers spread moving upwards, followed by a vertical line with a downward arrow, and a hand with fingers spread moving downwards.</p>
longer	<p>The SignWriting for 'longer' consists of a hand with fingers spread moving upwards, followed by a vertical line with a downward arrow, and a hand with fingers spread moving downwards.</p>
longsuffering	<p>The SignWriting for 'longsuffering' consists of a circle on the left, followed by a hand with fingers spread moving upwards, and a hand with fingers spread moving downwards.</p>
look	<p>The SignWriting for 'look' consists of a circle on the left, followed by a hand with fingers spread moving upwards, and a hand with fingers spread moving downwards.</p>

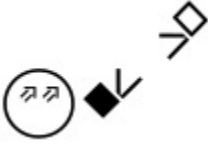

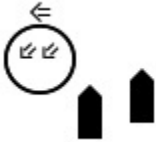
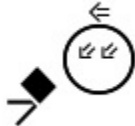

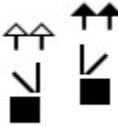
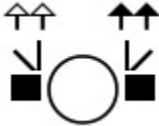

ASL Bible Dictionary

Spoken Word	SignWriting
look	
look	
look	
look	
look	
look	
look	
look	
look	
look	

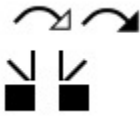
ASL Bible Dictionary

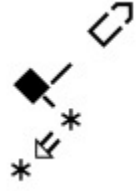
Spoken Word	SignWriting
look	
look	
look over	
look-away	
look-away	
look-for	
look-forward	
look-forward	
look-up	







ASL Bible Dictionary

Spoken Word	SignWriting
lookout	
loom	
Lord	
Lord	
Lord	
Lord	
Lord	

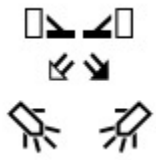
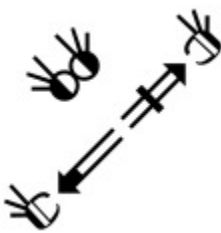





ASL Bible Dictionary

Spoken Word	SignWriting
Lord	<p>The sign for 'Lord' is written with two horizontal lines. The top line starts with a diamond shape pointing down and to the left, followed by a curved arrow pointing to the right. The bottom line starts with a diamond shape pointing down and to the right, followed by a curved arrow pointing to the left. Both lines end with an asterisk.</p>
lords	<p>The sign for 'lords' is written with a diamond shape pointing down and to the left, followed by a diamond shape pointing down and to the right, and then a diamond shape pointing down and to the left. Each diamond is followed by an asterisk.</p>
Los Angeles	<p>The sign for 'Los Angeles' is written with a diamond shape pointing down and to the left, followed by a diamond shape pointing down and to the right, and then a diamond shape pointing down and to the left. Each diamond is followed by an asterisk.</p>
Los Angeles	<p>The sign for 'Los Angeles' is written with a diamond shape pointing down and to the left, followed by a diamond shape pointing down and to the right, and then a diamond shape pointing down and to the left. Each diamond is followed by an asterisk.</p>
lose	<p>The sign for 'lose' is written with a diamond shape pointing down and to the left, followed by a diamond shape pointing down and to the right, and then a diamond shape pointing down and to the left. Each diamond is followed by an asterisk.</p>
loser	<p>The sign for 'loser' is written with a diamond shape pointing down and to the left, followed by a diamond shape pointing down and to the right, and then a diamond shape pointing down and to the left. Each diamond is followed by an asterisk.</p>
loss	<p>The sign for 'loss' is written with a diamond shape pointing down and to the left, followed by a diamond shape pointing down and to the right, and then a diamond shape pointing down and to the left. Each diamond is followed by an asterisk.</p>

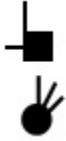
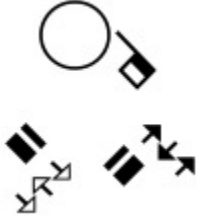

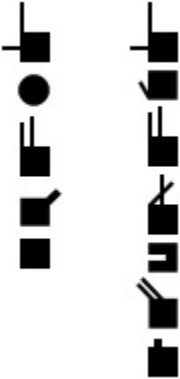



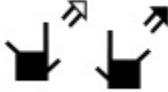

ASL Bible Dictionary

Spoken Word	SignWriting
lost	
lost	
lost	
Lot	
lot-draw	
Lotan	
lotion	
Lou	

ASL Bible Dictionary

Spoken Word	SignWriting
Lou Fant	
loud	
louder	
Louis-Laurent	
lousy	
love	
love	



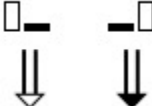

ASL Bible Dictionary

Spoken Word	SignWriting
love	
love	 
love	
love	
love	
love	
love	
loves	
lower	





ASL Bible Dictionary

Spoken Word	SignWriting
lower	<p>The signwriting for 'lower' consists of two identical L-shaped hand configurations. Each configuration has a downward-pointing arrow from the top horizontal bar, indicating a downward movement. The second configuration is positioned lower and to the right of the first, with an upward-pointing arrow from its top horizontal bar, indicating an upward movement.</p>
lower-back	<p>The signwriting for 'lower-back' is composed of two parts. The upper part shows a horizontal bar above two small squares, with a downward-pointing arrow from the bar. The lower part shows a horizontal bar above two small squares, with an upward-pointing arrow from the bar.</p>
lowercase	<p>The signwriting for 'lowercase' features a hand configuration with a downward-pointing arrow from the top horizontal bar, a small square to the right, and a small square below the hand.</p>
lowest	<p>The signwriting for 'lowest' consists of two hand configurations. The upper one has a downward-pointing arrow from the top horizontal bar, a small square to the right, and a small square below the hand. The lower one has an upward-pointing arrow from the top horizontal bar, a small square to the right, and a small square below the hand.</p>
loyal	<p>The signwriting for 'loyal' is a vertical sequence of five hand configurations: a horizontal bar with a downward-pointing arrow, a hand with a small square to the right, a hand with a small square to the right and a small square below, a hand with a small square to the right and a small square below, and a hand with a small square to the right and a small square below.</p>

ASL Bible Dictionary

Spoken Word	SignWriting
Lucifer	
Lucinda	
Lucinda	
Lucinda	

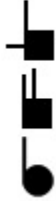
ASL Bible Dictionary

Spoken Word	SignWriting
Lucius	
luck	
Lud	
Ludim	
Ludwig	





ASL Bible Dictionary

Spoken Word	SignWriting
Luke	<p>The sign for 'Luke' is written vertically. It starts with a hand sign for 'L' (index finger pointing up, thumb pointing left, other fingers curled). This is followed by a hand sign for 'U' (index and middle fingers pointing up, thumb pointing left, other fingers curled). The final part is a hand sign for 'K' (index finger pointing up, thumb pointing left, other fingers curled).</p>
Luke	<p>The sign for 'Luke' is written vertically. It starts with a hand sign for 'L' (index finger pointing up, thumb pointing left, other fingers curled). This is followed by a hand sign for 'U' (index and middle fingers pointing up, thumb pointing left, other fingers curled). The final part is a hand sign for 'K' (index finger pointing up, thumb pointing left, other fingers curled) with two asterisks (**), indicating emphasis.</p>
lukewarm	<p>The sign for 'lukewarm' is written vertically. It starts with a hand sign for 'L' (index finger pointing up, thumb pointing left, other fingers curled). This is followed by a hand sign for 'U' (index and middle fingers pointing up, thumb pointing left, other fingers curled). The next part is a hand sign for 'K' (index finger pointing up, thumb pointing left, other fingers curled). This is followed by a hand sign for 'W' (index and middle fingers pointing up, thumb pointing left, other fingers curled). The final part is a hand sign for 'A' (index finger pointing up, thumb pointing left, other fingers curled).</p>
lull	<p>The sign for 'lull' is written vertically. It starts with a hand sign for 'L' (index finger pointing up, thumb pointing left, other fingers curled). This is followed by a hand sign for 'U' (index and middle fingers pointing up, thumb pointing left, other fingers curled). The final part is a hand sign for 'L' (index finger pointing up, thumb pointing left, other fingers curled).</p>
lunch	<p>The sign for 'lunch' is written vertically. It starts with a hand sign for 'L' (index finger pointing up, thumb pointing left, other fingers curled). This is followed by a hand sign for 'U' (index and middle fingers pointing up, thumb pointing left, other fingers curled). The final part is a hand sign for 'N' (index finger pointing up, thumb pointing left, other fingers curled).</p>



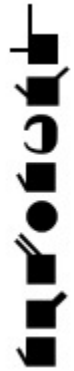

ASL Bible Dictionary

Spoken Word	SignWriting
lurks	<p>The signwriting for 'lurks' consists of four vertical elements: a circle with two diagonal lines inside, a solid black square with a right-pointing arrow, a solid black square with a left-pointing arrow and a zigzag line above it, and a solid black square with a small 'p' to its right.</p>
lust	<p>The signwriting for 'lust' consists of four vertical elements: a circle with a wavy line inside, a circle with a horizontal line through the center, a circle with a spiral inside, and a solid black square with two horizontal arrows pointing outwards.</p>
lust	<p>The signwriting for 'lust' consists of four vertical elements: a circle with a horizontal line through the center, a circle with a horizontal line through the center, a circle with a spiral inside, and a solid black square with two horizontal arrows pointing outwards.</p>
lust	<p>The signwriting for 'lust' consists of three vertical elements: a circle with a horizontal line through the center, a hand with fingers spread, and a solid black square with two horizontal arrows pointing outwards.</p>
lust	<p>The signwriting for 'lust' consists of two vertical elements: a hand with fingers spread, and a solid black square with two horizontal arrows pointing outwards.</p>
Lutheran	<p>The signwriting for 'Lutheran' consists of two vertical elements: a solid black square with a vertical line extending upwards from its top center, and a solid black square.</p>
luxury	<p>The signwriting for 'luxury' consists of two horizontal elements: a hand with fingers spread, a house with a chimney, a star, another house with a chimney, another star, and another hand with fingers spread.</p>



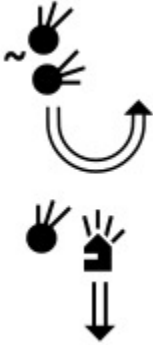

ASL Bible Dictionary

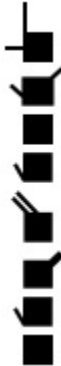
Spoken Word	SignWriting
Luz	
Lycaonia	
Lycia	
Lydda	
Lydia	

ASL Bible Dictionary

Spoken Word	SignWriting
Lyn	
lyre	
lyre	
lyre	
Lysanias	

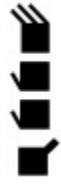

ASL Bible Dictionary

Spoken Word	SignWriting
Lysias	
Lystra	
M	
Maachah	
Maai	

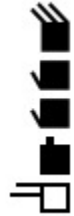

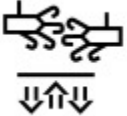

ASL Bible Dictionary

Spoken Word	SignWriting
Maaseiah	 The SignWriting for 'Maaseiah' is a vertical sequence of eight handshapes. From top to bottom: a hand with fingers spread and thumb up; a hand with index and middle fingers extended; a hand with index and middle fingers extended; a hand with index and middle fingers extended; a hand with index and middle fingers extended; a hand with index and middle fingers extended; a hand with index and middle fingers extended; and a hand with index and middle fingers extended.
Maath	 The SignWriting for 'Maath' is a vertical sequence of six handshapes. From top to bottom: a hand with fingers spread and thumb up; a hand with index and middle fingers extended; a hand with index and middle fingers extended; a hand with index and middle fingers extended; a hand with index and middle fingers extended; and a hand with index and middle fingers extended.

ASL Bible Dictionary

Spoken Word	SignWriting
<p>Maaziah</p>	
<p>MacArthur</p>	
<p>Macedonia</p>	
<p>machine</p>	



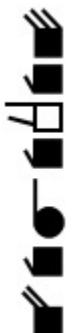

ASL Bible Dictionary

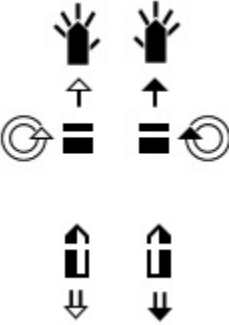
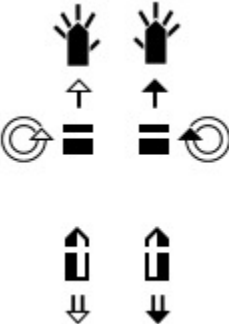
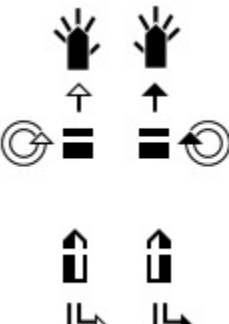
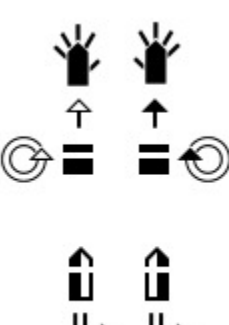
Spoken Word	SignWriting
Machir	
Machpelah	
Madai	
made	
Magadan	

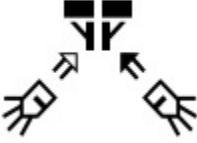

ASL Bible Dictionary

Spoken Word	SignWriting
magician	 <p>The SignWriting for 'magician' consists of two columns of signs. The top column shows two identical signs: a hand with fingers spread, an upward arrow, a horizontal bar, and a circular arrow. The bottom column shows two identical signs: a hand with fingers spread, a downward arrow, and a horizontal bar.</p>
magician	 <p>The SignWriting for 'magician' consists of two columns of signs. The top column shows two identical signs: a hand with fingers spread, an upward arrow, a horizontal bar, and a circular arrow. The bottom column shows two identical signs: a hand with fingers spread, a downward arrow, and a horizontal bar.</p>
magicians	 <p>The SignWriting for 'magicians' consists of two columns of signs. The top column shows two identical signs: a hand with fingers spread, an upward arrow, a horizontal bar, and a circular arrow. The bottom column shows two identical signs: a hand with fingers spread, a downward arrow, and a horizontal bar with a rightward-pointing arrowhead.</p>
magicians	 <p>The SignWriting for 'magicians' consists of two columns of signs. The top column shows two identical signs: a hand with fingers spread, an upward arrow, a horizontal bar, and a circular arrow. The bottom column shows two identical signs: a hand with fingers spread, a downward arrow, and a horizontal bar with a rightward-pointing arrowhead.</p>





ASL Bible Dictionary

Spoken Word	SignWriting
magnetic	
Magog	
Magpiash	
Mahalaleel	





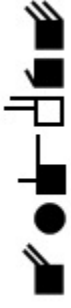

ASL Bible Dictionary

Spoken Word	SignWriting
<p>Mahalalel</p>	
<p>Mahalath</p>	
<p>Mahanah-</p>	

ASL Bible Dictionary

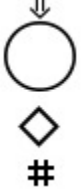
Spoken Word	SignWriting
Mahanaim	
Mahaneh-	
mahlon	
Mahujael	

ASL Bible Dictionary

Spoken Word	SignWriting
Mahujael	
mainstream	
Majesty	
majesty	
majesty	
majesty	



ASL Bible Dictionary

Spoken Word	SignWriting
majesty	<p>The SignWriting for 'majesty' consists of two parts. The first part shows a hand with fingers spread, a vertical line, and two asterisks. The second part shows a hand with fingers spread, a vertical line, and a small square.</p>
make	<p>The SignWriting for 'make' consists of a vertical sequence of three squares, followed by a cluster of four squares.</p>
maker	<p>The SignWriting for 'maker' consists of a vertical sequence of three squares, followed by a cluster of four squares, and then two separate vertical sequences of two squares each, one on the left and one on the right.</p>
Maker	<p>The SignWriting for 'Maker' consists of a vertical sequence of three squares, followed by a cluster of four squares, and then two separate vertical sequences of two squares each, one on the left and one on the right.</p>
makers	<p>The SignWriting for 'makers' consists of a vertical sequence of three squares, followed by a cluster of four squares, and then two separate vertical sequences of two squares each, one on the left and one on the right.</p>

ASL Bible Dictionary

Spoken Word	SignWriting
<p>makes-up</p>	<p>The SignWriting for 'makes-up' consists of several components: a diamond shape with a diagonal line, a horizontal line, a vertical line, and a square with a diagonal line.</p>
<p>makeup</p>	<p>The SignWriting for 'makeup' features a central circle with two arrows forming a loop around it, and two smaller circles below the main circle.</p>
<p>Malachi</p>	<p>The SignWriting for 'Malachi' is a vertical sequence of symbols: a hand with fingers spread, a vertical line, a horizontal line, a vertical line, a circle, a vertical line, a horizontal line, and a vertical line.</p>
<p>Malchiel</p>	<p>The SignWriting for 'Malchiel' is a vertical sequence of symbols: a hand with fingers spread, a vertical line, a horizontal line, a vertical line, a circle, a vertical line, a horizontal line, a vertical line, and a horizontal line.</p>

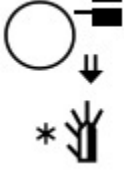



ASL Bible Dictionary

Spoken Word	SignWriting
Malchus	
male	
Malkijah	
mall	

ASL Bible Dictionary

Spoken Word	SignWriting
man	<p>The SignWriting for 'man' consists of two parts. The first part is a circle with three curved lines inside, representing the mouth, with a small square to its right. An arrow points down from this symbol to a second symbol. The second symbol is a hand with fingers spread, with an asterisk to its left, representing the sign for 'man'.</p>
Manaen	<p>The SignWriting for 'Manaen' is a vertical sequence of seven hand symbols. From top to bottom: a hand with fingers spread, a hand with fingers spread, a hand with fingers spread, a hand with fingers spread, a hand with fingers spread, a hand with fingers spread, and a hand with fingers spread.</p>
Manahath	<p>The SignWriting for 'Manahath' is a vertical sequence of seven hand symbols. From top to bottom: a hand with fingers spread, a hand with fingers spread, a hand with fingers spread, a hand with fingers spread, a hand with fingers spread, a hand with fingers spread, and a hand with fingers spread.</p>
Manasseh	<p>The SignWriting for 'Manasseh' is a vertical sequence of seven hand symbols. From top to bottom: a hand with fingers spread, a hand with fingers spread, a hand with fingers spread, a hand with fingers spread, a hand with fingers spread, a hand with fingers spread, and a hand with fingers spread.</p>

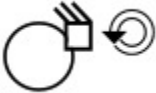

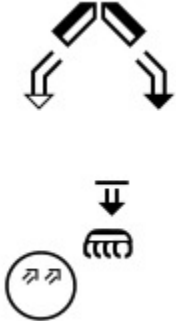

ASL Bible Dictionary

Spoken Word	SignWriting
manipulate	
manna	
Manoah	
Manoah	
Manoah	
mansion	





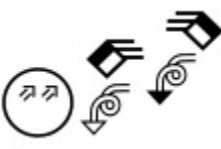

ASL Bible Dictionary

Spoken Word	SignWriting
manual	<p>The signwriting for 'manual' consists of two parts. The first part shows two hands with fingers spread, each with a small circle above it, and a vertical double-headed arrow between them. The second part shows two hands with fingers spread, each with a small circle above it, and two vertical arrows pointing up from the palms.</p>
manure	<p>The signwriting for 'manure' shows a hand with fingers spread and a small circle above it, with a vertical double-headed arrow. A rectangular box is positioned above the hand, and a vertical arrow points down from the bottom of the box.</p>
many	<p>The signwriting for 'many' consists of two identical parts. Each part shows a hand with fingers spread and a small circle above it, with a vertical double-headed arrow. Below the hand is a small rectangle.</p>
many	<p>The signwriting for 'many' consists of two identical parts. Each part shows a hand with fingers spread and a small circle above it, with a vertical double-headed arrow. Below the hand is a small rectangle. A horizontal line is drawn above the right-hand part.</p>
many	<p>The signwriting for 'many' consists of two identical parts. Each part shows a hand with fingers spread and a small circle above it, with a vertical double-headed arrow. Below the hand is a small rectangle.</p>
many	<p>The signwriting for 'many' consists of two identical parts. Each part shows a hand with fingers spread and a small circle above it, with a vertical double-headed arrow. Below the hand is a small rectangle. A larger circle with two horizontal lines inside is positioned above the two parts.</p>
many	<p>The signwriting for 'many' consists of two identical parts. Each part shows a hand with fingers spread and a small circle above it, with a vertical double-headed arrow. Below the hand is a small rectangle. A larger circle with two horizontal lines inside is positioned above the two parts.</p>





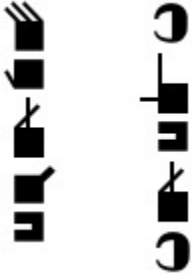



ASL Bible Dictionary

Spoken Word	SignWriting
Mara	
Maranatha	
Maranatha	
marble	
March	



ASL Bible Dictionary

Spoken Word	SignWriting
march	
march	
Marcus	
Maria	
Marie-Clerc	
marine	





ASL Bible Dictionary

Spoken Word	SignWriting
Marine	
mark	
Mark	
Mark 16-9-20d	
Mark09v09 NLT	
marriage	
married	
marry	
marry	
marry	







ASL Bible Dictionary

Spoken Word	SignWriting
marry	
Marsena	
Martha	





ASL Bible Dictionary

Spoken Word	SignWriting
martyr	
Mary	
Mary	
MaryAnn	
Maryland	

ASL Bible Dictionary

Spoken Word	SignWriting
Mash	
mask	
Mason	
Mason	
mass	
mass	
Mass	



ASL Bible Dictionary

Spoken Word	SignWriting
Massa	
master	
masters	
masters	
masters	



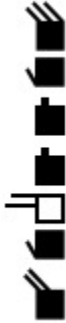

ASL Bible Dictionary

Spoken Word	SignWriting
mat	<p>The SignWriting for 'mat' consists of three vertical handshapes: a hand with fingers spread, a hand with the index finger pointing down, and a flat hand.</p>
match	<p>The SignWriting for 'match' consists of two hands, each with the index finger pointing towards the center, and two arrows pointing outwards from the hands.</p>
Matred	<p>The SignWriting for 'Matred' consists of a sequence of seven handshapes: a hand with fingers spread, a hand with the index finger pointing down, a flat hand, a hand with the index finger pointing down, a hand with the index finger pointing down, a hand with the index finger pointing down, and a hand with the index finger pointing down.</p>
matron	<p>The SignWriting for 'matron' consists of a sequence of seven handshapes: a hand with fingers spread, a hand with the index finger pointing down, a flat hand, a hand with the index finger pointing down, a hand with the index finger pointing down, a hand with the index finger pointing down, and a hand with the index finger pointing down.</p>
Mattaniah	<p>The SignWriting for 'Mattaniah' consists of a sequence of ten handshapes: a hand with fingers spread, a hand with the index finger pointing down, a flat hand, a hand with the index finger pointing down, a hand with the index finger pointing down, a hand with the index finger pointing down, a hand with the index finger pointing down, a hand with the index finger pointing down, a hand with the index finger pointing down, and a hand with the index finger pointing down.</p>







ASL Bible Dictionary

Spoken Word	SignWriting
<p>Mattatha</p>	
<p>Mattathias</p>	
<p>Mattenai</p>	
<p>Matthan</p>	





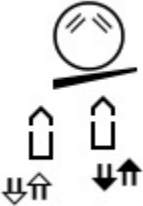



ASL Bible Dictionary

Spoken Word	SignWriting
Matthat	
Matthew	
Matthew	
Matthias	







ASL Bible Dictionary

Spoken Word	SignWriting
Mattithiah	
mature	
May	
may	
maybe	
maybe	
maybe	

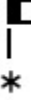
ASL Bible Dictionary

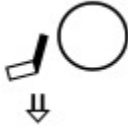
Spoken Word	SignWriting
McShain	
MD	
MD	
MD	
me	
me	
me	
Me	

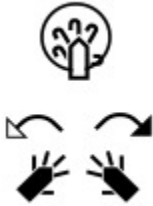
ASL Bible Dictionary

Spoken Word	SignWriting
me	
me	
me	
me	
me	
meadow	
mean	
means	







ASL Bible Dictionary

Spoken Word	SignWriting
meanwhile	<p>The SignWriting for 'meanwhile' consists of a circle at the top with two horizontal lines inside. Below it are two hands, each with a square palm and fingers pointing down. Arrows point from the hands towards the center, indicating a simultaneous or overlapping action.</p>
measure	<p>The SignWriting for 'measure' shows two hands with square palms and fingers pointing down. Arrows point from the hands towards each other, indicating a measurement or comparison.</p>
meat	<p>The SignWriting for 'meat' depicts a hand with a square palm and fingers pointing down, with a plus sign (+) next to it, representing the concept of meat.</p>
Meconah	<p>The SignWriting for 'Meconah' is a vertical sequence of signs: a hand with a square palm and fingers pointing down, followed by a circle with a horizontal line through it, then a hand with a square palm and fingers pointing down, and finally a hand with a square palm and fingers pointing down.</p>
Medan	<p>The SignWriting for 'Medan' is a vertical sequence of signs: a hand with a square palm and fingers pointing down, followed by a circle with a horizontal line through it, then a hand with a square palm and fingers pointing down, and finally a hand with a square palm and fingers pointing down.</p>
Medes	<p>The SignWriting for 'Medes' is a vertical sequence of signs: a hand with a square palm and fingers pointing down, followed by a circle with a horizontal line through it, then a hand with a square palm and fingers pointing down, and finally a hand with a square palm and fingers pointing down.</p>





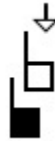

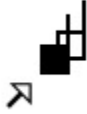

ASL Bible Dictionary

Spoken Word	SignWriting
media	<p>The sign for 'media' is written vertically. It starts with a hand sign for 'M' (open hand, palm facing left), followed by a hand sign for 'D' (open hand, palm facing left), then a hand sign for 'I' (open hand, palm facing left), and finally a hand sign for 'A' (open hand, palm facing left).</p>
Media	<p>The sign for 'Media' is written vertically. It starts with a hand sign for 'M' (open hand, palm facing left), followed by a hand sign for 'D' (open hand, palm facing left), then a hand sign for 'I' (open hand, palm facing left), and finally a hand sign for 'A' (open hand, palm facing left).</p>
mediate	<p>The sign for 'mediate' is written vertically. It starts with a hand sign for 'M' (open hand, palm facing left), followed by a hand sign for 'D' (open hand, palm facing left), then a hand sign for 'I' (open hand, palm facing left), and finally a hand sign for 'A' (open hand, palm facing left).</p>
mediator	<p>The sign for 'mediator' is written vertically. It starts with a hand sign for 'M' (open hand, palm facing left), followed by a hand sign for 'D' (open hand, palm facing left), then a hand sign for 'I' (open hand, palm facing left), and finally a hand sign for 'A' (open hand, palm facing left).</p>
meditate	<p>The sign for 'meditate' is written vertically. It starts with a hand sign for 'M' (open hand, palm facing left), followed by a hand sign for 'D' (open hand, palm facing left), then a hand sign for 'I' (open hand, palm facing left), and finally a hand sign for 'A' (open hand, palm facing left).</p>
meditate	<p>The sign for 'meditate' is written vertically. It starts with a hand sign for 'M' (open hand, palm facing left), followed by a hand sign for 'D' (open hand, palm facing left), then a hand sign for 'I' (open hand, palm facing left), and finally a hand sign for 'A' (open hand, palm facing left).</p>

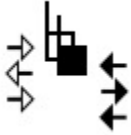
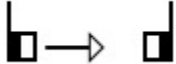

ASL Bible Dictionary

Spoken Word	SignWriting
Mediterranean	
Mediterranean	
meet	
meet	
meet	
meet	
meet	



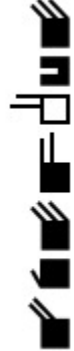
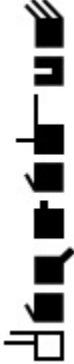

ASL Bible Dictionary

Spoken Word	SignWriting
meet	
meet	
meet	
meet-one	
meeting	
meeting	
meeting	
meets	
Mehetabel	

ASL Bible Dictionary

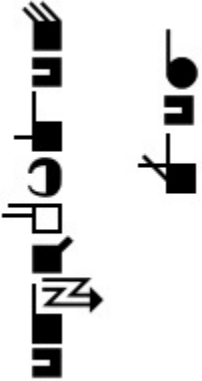
Spoken Word	SignWriting
Mehida	
Mehujael	
Mehuman	
Melatiah	

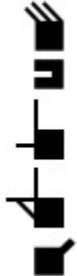



ASL Bible Dictionary

Spoken Word	SignWriting
Melchizedek	 <p>The SignWriting for 'Melchizedek' consists of two vertical columns of signs. The left column contains the signs for M, E, L, C, H, I, Z, E, D, E, K. The right column contains the signs for M, E, L, C, H, I, Z, E, D, E, K.</p>
Melea	 <p>The SignWriting for 'Melea' consists of a single vertical column of signs: M, E, L, E, A.</p>
Melki	 <p>The SignWriting for 'Melki' consists of a single vertical column of signs: M, E, L, K, I.</p>
mellitus	 <p>The SignWriting for 'mellitus' consists of a single vertical column of signs: M, E, L, L, I, T, U, S.</p>
melon	 <p>The SignWriting for 'melon' consists of a single vertical column of signs: M, E, L, O, N.</p>

ASL Bible Dictionary

Spoken Word	SignWriting
member	<p>The sign for 'member' is composed of three elements: a diamond shape with three horizontal lines extending from its left side, followed by an asterisk, and then an arrow pointing to the right towards another asterisk.</p>
memorial	<p>The sign for 'memorial' is a vertical sequence of eight distinct hand configurations, each represented by a unique geometric shape or symbol.</p>
memorial	<p>The sign for 'memorial' consists of a circle on the left, followed by a square with a diagonal line, and then a square with a downward-pointing arrow.</p>
memories	<p>The sign for 'memories' includes a circle, a diamond with a diagonal line, and a diamond with a downward-pointing arrow.</p>
memory	<p>The sign for 'memory' features a circle, a square with a diagonal line, and a square with a downward-pointing arrow.</p>

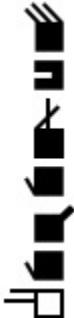

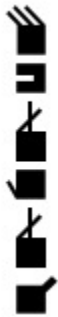



ASL Bible Dictionary

Spoken Word	SignWriting
Menna	
Menorah	
Meraiah	
Meraioth	
Merari	





ASL Bible Dictionary

Spoken Word	SignWriting
merchant	<p>The sign for 'merchant' is composed of two parts. The first part consists of two sets of 'J' characters, one on the left and one on the right, with two upward-pointing arrows above each. Below these are two downward-pointing triangles. The second part consists of two vertical bars, one on the left and one on the right, with a downward-pointing arrow below each.</p>
merchants	<p>The sign for 'merchants' is similar to 'merchant' but includes a small arrow pointing to the right at the bottom of each vertical bar.</p>
merciful	<p>The sign for 'merciful' starts with a circle containing two small 'r' characters. This is followed by a sequence of hand movements: a hand with fingers spread moving down and right, a hand with fingers spread moving down and left, and a hand with fingers spread moving down and right.</p>
mercy	<p>The sign for 'mercy' is identical to the sign for 'merciful'.</p>
mercy	<p>The sign for 'mercy' consists of two hand movements: a hand with fingers spread moving down and right, followed by a hand with fingers spread moving down and left.</p>
mercy	<p>The sign for 'mercy' consists of two hand movements: a hand with fingers spread moving down and left, followed by a hand with fingers spread moving down and right.</p>
mercy	<p>The sign for 'mercy' consists of three hand movements: a hand with fingers spread moving down and left, a hand with fingers spread moving down and right, and a hand with fingers spread moving down and left.</p>



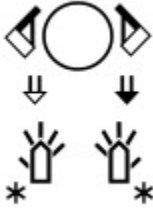
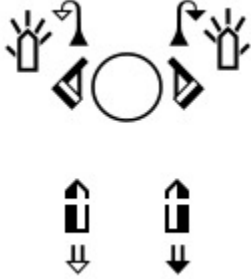
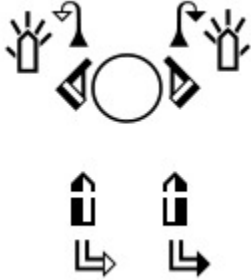

ASL Bible Dictionary

Spoken Word	SignWriting
mercy	
mercy	
Meremoth	
Meres	
Meremoth	
Mesa	







ASL Bible Dictionary

Spoken Word	SignWriting
message	
message	
message	
messenger	
messengers	
Messiah	
Messiah	







ASL Bible Dictionary

Spoken Word	SignWriting
Methusael	
Methuselah	
metres	
metro	



ASL Bible Dictionary

Spoken Word	SignWriting
MHS	
mi	
Mibsam	
Mibzar	
Micah	
Micaiah	



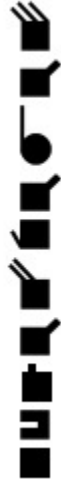
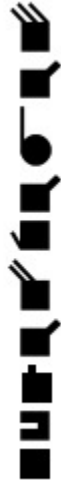

ASL Bible Dictionary

Spoken Word	SignWriting
Michael	
Michigan	
Mickey Mouse	
Micmash	
middle	
Midian	





ASL Bible Dictionary

Spoken Word	SignWriting
<p>Midianites</p>	
<p>Midianites</p>	
<p>midnight</p>	
<p>Mijamin</p>	





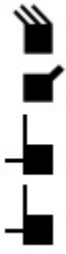

ASL Bible Dictionary

Spoken Word	SignWriting
Milalai	
Milan	
Milcah	
mile	
miles	





ASL Bible Dictionary

Spoken Word	SignWriting
Miletus	
milk	
milk	
Milky Way	
mill	
mill	

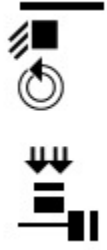

ASL Bible Dictionary

Spoken Word	SignWriting
million	
million	
mime	
mind	
mind-own-business	
minds	
mine	

ASL Bible Dictionary

Spoken Word	SignWriting
Miner	
Miniamin	
ministry	
ministry	
minor	



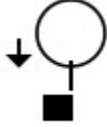

ASL Bible Dictionary

Spoken Word	SignWriting
Mishma	
Mispar	
miss	
miss	



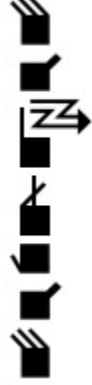

ASL Bible Dictionary

Spoken Word	SignWriting
mission	<p>The signwriting for 'mission' consists of a vertical sequence of symbols: a hand with fingers spread, a vertical line, a series of horizontal bars, a circle, and a hand with fingers spread.</p>
missionary	<p>The signwriting for 'missionary' consists of a hand with fingers spread, a vertical line, and a circle with a hand inside.</p>
Mississippi	<p>The signwriting for 'Mississippi' consists of a circle, two asterisks, and a hand with fingers spread.</p>
missmyson	
mist	<p>The signwriting for 'mist' consists of a circle with two arrows, a hand with fingers spread, and another hand with fingers spread.</p>
misunderstand	<p>The signwriting for 'misunderstand' consists of a circle with a hand inside, and a circle with a hand inside.</p>



ASL Bible Dictionary

Spoken Word	SignWriting
Mitylene	
mix	
mixture	
Mizpah	
Mizraim	

ASL Bible Dictionary

Spoken Word	SignWriting
Mizzah	
MMSC	
Mnason	
Moab	
Moabites	

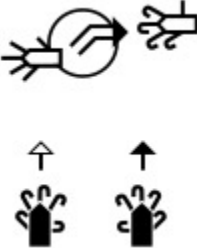

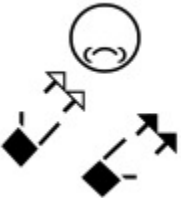
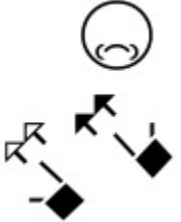
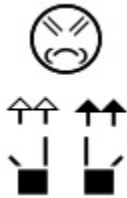



ASL Bible Dictionary

Spoken Word	SignWriting
Moadiah	
mob	
mob	
mock	
mock	
mock	

ASL Bible Dictionary

Spoken Word	SignWriting
mock	<p>The sign for 'mock' is represented by two diamond shapes. The first diamond has an arrow pointing up and to the left, and another arrow pointing down and to the left. The second diamond has an arrow pointing up and to the right, and another arrow pointing down and to the right.</p>
mocker	<p>The sign for 'mocker' consists of two vertical sequences of hand movements. Each sequence starts with two upward-pointing arrows, followed by a downward-pointing arrow, a solid black square, and another downward-pointing arrow. The second sequence is identical to the first.</p>
mockers	<p>The sign for 'mockers' begins with a circle containing a crescent moon, representing the plural marker. This is followed by two vertical sequences of hand movements, each identical to the sign for 'mocker'.</p>
model	<p>The sign for 'model' is a vertical sequence of hand movements: a hand with fingers spread, a solid black circle, a horizontal line, a solid black circle, a hand with fingers spread, a horizontal line, a solid black square, and a hand with fingers spread.</p>
modified	<p>The sign for 'modified' is a vertical sequence of hand movements: a hand with fingers spread, a solid black circle, a horizontal line, a solid black circle, a hand with fingers spread, a solid black square, a hand with fingers spread, a horizontal line, a solid black circle, a hand with fingers spread, a horizontal line, a solid black circle, and a hand with fingers spread.</p>

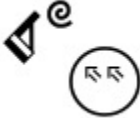

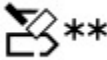



ASL Bible Dictionary

Spoken Word	SignWriting
Molada	
Molech	
mom	
Monday	
money	
money	
money	





ASL Bible Dictionary

Spoken Word	SignWriting
money-no	<p>The signwriting for 'money-no' consists of a hand sign for 'money' (a hand with fingers spread, palm facing left) and a hand sign for 'no' (a hand with fingers spread, palm facing right, with a question mark above it). A small circle with a hand sign inside is positioned above the 'no' sign.</p>
monogenic	<p>The signwriting for 'monogenic' is a vertical sequence of hand signs: a hand with fingers spread, palm facing left; a hand with fingers spread, palm facing right; a hand with fingers spread, palm facing left; a hand with fingers spread, palm facing right; a hand with fingers spread, palm facing left; a hand with fingers spread, palm facing right; a hand with fingers spread, palm facing left; a hand with fingers spread, palm facing right; a hand with fingers spread, palm facing left; a hand with fingers spread, palm facing right.</p>
monotony	<p>The signwriting for 'monotony' consists of two hand signs for 'monotony' (a hand with fingers spread, palm facing left, with a question mark above it) and two hand signs for 'monotony' (a hand with fingers spread, palm facing right, with a question mark above it).</p>
month	<p>The signwriting for 'month' consists of a hand sign for 'month' (a hand with fingers spread, palm facing left, with a question mark above it) and a hand sign for 'month' (a hand with fingers spread, palm facing right, with a question mark above it).</p>
months	<p>The signwriting for 'months' consists of a hand sign for 'months' (a hand with fingers spread, palm facing left, with a question mark above it) and a hand sign for 'months' (a hand with fingers spread, palm facing right, with a question mark above it).</p>
monuments	<p>The signwriting for 'monuments' is a vertical sequence of hand signs: a hand with fingers spread, palm facing left; a hand with fingers spread, palm facing right; a hand with fingers spread, palm facing left; a hand with fingers spread, palm facing right; a hand with fingers spread, palm facing left; a hand with fingers spread, palm facing right; a hand with fingers spread, palm facing left; a hand with fingers spread, palm facing right; a hand with fingers spread, palm facing left; a hand with fingers spread, palm facing right.</p>





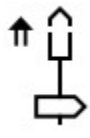
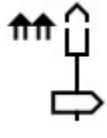

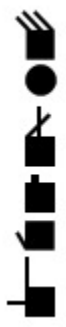

ASL Bible Dictionary

Spoken Word	SignWriting
Mordecai	
Mordecai	
more	
more	
more	
Moreh	
Moreh	









ASL Bible Dictionary

Spoken Word	SignWriting
Moriah	
Moriah Day	
morning	
morning	
morphology	
mortal	





ASL Bible Dictionary

Spoken Word	SignWriting
most	
most	
most	
most	
Motegi	
moth-eats	
mother	
mother	



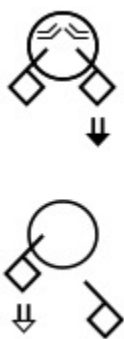

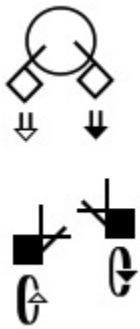

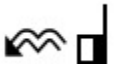

ASL Bible Dictionary

Spoken Word	SignWriting
mother	
moths	
motive	
motorcycle	
mound	
mound	
mount	
mount	

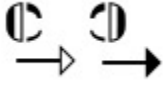
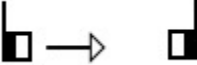



ASL Bible Dictionary

Spoken Word	SignWriting
mountain	
mourn	
mourn	
mourners	
mouth	
move	
move	





ASL Bible Dictionary

Spoken Word	SignWriting
move	
move	
move	
move	
move	
move-l	
move-r	
movement	
movies	

ASL Bible Dictionary

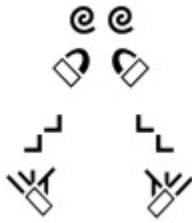
Spoken Word	SignWriting
MPAS	
Ms.	
mt	
much	

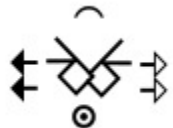
ASL Bible Dictionary

Spoken Word	SignWriting
mud	
mulberry	
multiply	
multiply	
multiply	

ASL Bible Dictionary

Spoken Word	SignWriting
municipal	<p>The SignWriting for 'municipal' consists of a vertical sequence of 11 handshapes. From top to bottom: a hand with fingers spread, a hand with index and middle fingers extended, a hand with index and middle fingers extended, a hand with index and middle fingers extended, a hand with index and middle fingers extended, a hand with index and middle fingers extended, a hand with index and middle fingers extended, a hand with index and middle fingers extended, a hand with index and middle fingers extended, a hand with index and middle fingers extended, and a hand with index and middle fingers extended.</p>
Muppim	<p>The SignWriting for 'Muppim' consists of a vertical sequence of 6 handshapes. From top to bottom: a hand with fingers spread, a hand with index and middle fingers extended, a hand with index and middle fingers extended, a hand with index and middle fingers extended, a hand with index and middle fingers extended, and a hand with index and middle fingers extended.</p>
murder	<p>The SignWriting for 'murder' consists of a single handshape: a hand with index and middle fingers extended, with an arrow pointing from the index finger towards the middle finger.</p>
murderer	<p>The SignWriting for 'murderer' consists of two parts. The first part is a handshape with index and middle fingers extended and an arrow pointing from the index finger towards the middle finger. The second part consists of two identical handshapes, each with index and middle fingers extended and an arrow pointing downwards from the index finger.</p>





ASL Bible Dictionary

Spoken Word	SignWriting
murderers	<p>The sign for 'murderers' consists of three parts: a hand starting at the forehead and moving diagonally down and to the right, ending with a diamond shape; two hands starting at the chest level and moving down and to the right, each ending with a diamond shape.</p>
murderous	<p>The sign for 'murderous' consists of a hand starting at the forehead and moving diagonally down and to the right, ending with a diamond shape, and a small horizontal line below it.</p>
murmur	<p>The sign for 'murmur' consists of a hand starting at the forehead and moving diagonally down and to the right, ending with a diamond shape, and a hand starting at the chest level and moving down and to the right, ending with two asterisks.</p>
museum	<p>The sign for 'museum' consists of two hands starting at the chest level and moving down and to the right, each ending with a diamond shape.</p>
Music - I walked p1	
Music - I walked p2	
Music - I walked p3	
Muslim	<p>The sign for 'Muslim' consists of two identical parts: a hand starting at the forehead and moving diagonally down and to the right, ending with a diamond shape, and a hand starting at the chest level and moving down and to the right, ending with a diamond shape.</p>
must	<p>The sign for 'must' consists of a hand starting at the forehead and moving diagonally down and to the right, ending with a diamond shape, and a hand starting at the chest level and moving down and to the right, ending with a diamond shape.</p>

ASL Bible Dictionary

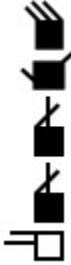
Spoken Word	SignWriting
my	
my	
my	
my	
my	
my	
my	
my	
my	
My Precious Sister	





ASL Bible Dictionary

Spoken Word	SignWriting
Myra	
myrrh	
myrrh	
myrtle	
myself	
Mysia	





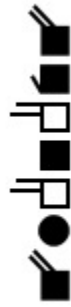

ASL Bible Dictionary

Spoken Word	SignWriting
mystery	<p>The sign for 'mystery' is composed of four distinct signs: a diamond shape with a diagonal line, a square with a diagonal line, a square with an arrow pointing up and to the right, and a circle with a diamond shape inside and two asterisks below it.</p>
N	<p>The sign for 'N' is a single black square with a diagonal line from the top-left to the bottom-right.</p>
Naamah	<p>The sign for 'Naamah' is a sequence of seven signs: a diagonal line, a square with a diagonal line, a square with a diagonal line, a square with a diagonal line, a square with a diagonal line, a square with a diagonal line, and a square with a diagonal line.</p>
Naaman	<p>The sign for 'Naaman' is a sequence of seven signs: a diagonal line, a square with a diagonal line, a square with a diagonal line, a square with a diagonal line, a square with a diagonal line, a square with a diagonal line, and a square with a diagonal line.</p>
NAD	<p>The sign for 'NAD' is a sequence of three signs: a diagonal line, a square with a diagonal line, and a solid black circle.</p>
nag	<p>The sign for 'nag' is a sequence of four signs: a circle with a face and two asterisks, a square with a diagonal line, a square with a diagonal line, and three upward-pointing arrows.</p>





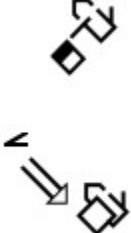



ASL Bible Dictionary

Spoken Word	SignWriting
Naggai	
Nahamani	
Nahath	
Nahor	
Nahshon	

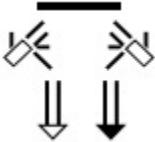



ASL Bible Dictionary

Spoken Word	SignWriting
Nahum	
nail-feet	
nail-sign	
nailed	
nailed	
nails	

ASL Bible Dictionary

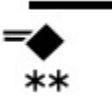
Spoken Word	SignWriting
nails	
Nain	
naked	
name	
name	
name	
name	
name	
name-tag	

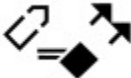
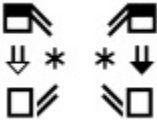

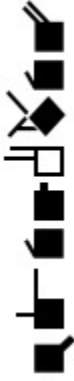
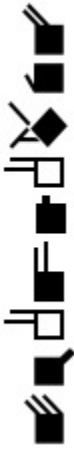

ASL Bible Dictionary

Spoken Word	SignWriting
names	
Nancy	
Nancy	
Nancy	
Nancy	
Naomi	
Naphish	



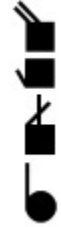



ASL Bible Dictionary

Spoken Word	SignWriting
<p>Naphish</p>	
<p>Naphtali</p>	
<p>Naphtuhim</p>	

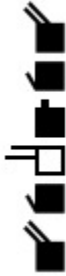
ASL Bible Dictionary

Spoken Word	SignWriting
Narcissus	
nard	
narrow	
NASCAR	
Nashon	





ASL Bible Dictionary

Spoken Word	SignWriting
Nathan	
Nathanael	
nation	
national	
nations	
natural	





ASL Bible Dictionary

Spoken Word	SignWriting
naturally	
nature	
navy	
Nazarene	
Nazarenes	







ASL Bible Dictionary

Spoken Word	SignWriting
Neapolis	 <p>The SignWriting for 'Neapolis' consists of a vertical sequence of symbols: a hand with fingers spread, a hand with fingers spread, a hand with fingers spread, a diamond shape with a diagonal line, a solid circle, a horizontal line, a hand with fingers spread, a hand with fingers spread, and a solid square.</p>
near	 <p>The SignWriting for 'near' consists of three symbols: a hand with fingers spread, a hand with fingers spread, and a hand with fingers spread.</p>
near	 <p>The SignWriting for 'near' consists of three symbols: a hand with fingers spread, a hand with fingers spread, and a hand with fingers spread.</p>
near	 <p>The SignWriting for 'near' consists of three symbols: a hand with fingers spread, a hand with fingers spread, and a hand with fingers spread.</p>

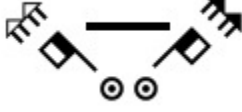
ASL Bible Dictionary

Spoken Word	SignWriting
Neballat	
Nebo	
Nebuchadnezzar	
Nebuchadnezzar	
neck	



ASL Bible Dictionary

Spoken Word	SignWriting
necklace	
necklace	
need	
need	
need	
need	
need	
need	

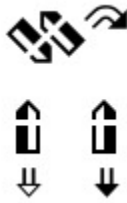

ASL Bible Dictionary

Spoken Word	SignWriting
needle	
needle-eye	
needle-through	
needsleep	
needy	
negative	
Negev	
Nehemiah	

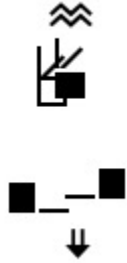

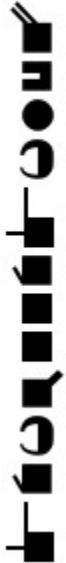

ASL Bible Dictionary

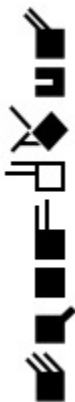
Spoken Word	SignWriting
Nehemiah	
neighbor	
neighbors	
Neil	
neither	



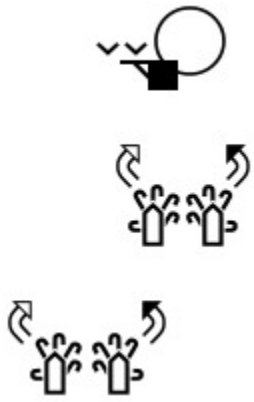

ASL Bible Dictionary

Spoken Word	SignWriting
Nekoda	
neoclassical	
neon	
nephew	
Nephusim	







ASL Bible Dictionary

Spoken Word	SignWriting
Nereus	
Neri	
nervous	
nest	
nests	





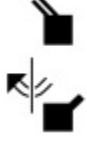

ASL Bible Dictionary

Spoken Word	SignWriting
Netophah	
Netophathite	
nets	
network	

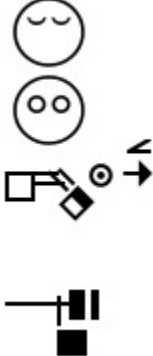





ASL Bible Dictionary

Spoken Word	SignWriting
neutral	
never	
never	
never	
nevertheless	
new	
new	
New Jersey	





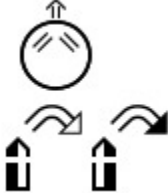

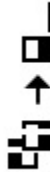
ASL Bible Dictionary

Spoken Word	SignWriting
New Orleans	
New York heartbeat	
Newport	
news	
news	
newspaper	
New York	

ASL Bible Dictionary

Spoken Word	SignWriting
next	
next	
next	
next	
next	
next	
next	
next-year	







ASL Bible Dictionary

Spoken Word	SignWriting
Neziah	
NFL	
NFPA	
Nicanor	
Nicaragua	
nice	

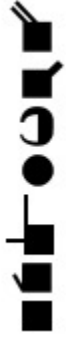
ASL Bible Dictionary

Spoken Word	SignWriting
nickname	<p>The SignWriting for 'nickname' consists of two handshapes. The first handshape is a square with a diagonal line from the top-left to the bottom-right, with an arrow pointing up and to the right. The second handshape is a square with a diagonal line from the top-left to the bottom-right, with an arrow pointing up and to the left.</p>
Nicodemus	<p>The SignWriting for 'Nicodemus' consists of two handshapes. The first handshape is a square with a diagonal line from the top-left to the bottom-right, with an arrow pointing up and to the right. The second handshape is a square with a diagonal line from the top-left to the bottom-right, with an arrow pointing up and to the left.</p>
Nicodemus	<p>The SignWriting for 'Nicodemus' consists of a vertical sequence of handshapes: a square with a diagonal line from the top-left to the bottom-right, with an arrow pointing up and to the right; a square with a diagonal line from the top-left to the bottom-right, with an arrow pointing up and to the left; a square with a diagonal line from the top-left to the bottom-right, with an arrow pointing up and to the right; a square with a diagonal line from the top-left to the bottom-right, with an arrow pointing up and to the left; a square with a diagonal line from the top-left to the bottom-right, with an arrow pointing up and to the right; a square with a diagonal line from the top-left to the bottom-right, with an arrow pointing up and to the left; a square with a diagonal line from the top-left to the bottom-right, with an arrow pointing up and to the right; a square with a diagonal line from the top-left to the bottom-right, with an arrow pointing up and to the left; a square with a diagonal line from the top-left to the bottom-right, with an arrow pointing up and to the right; a square with a diagonal line from the top-left to the bottom-right, with an arrow pointing up and to the left.</p>
Nicolaitan	<p>The SignWriting for 'Nicolaitan' consists of a vertical sequence of handshapes: a square with a diagonal line from the top-left to the bottom-right, with an arrow pointing up and to the right; a square with a diagonal line from the top-left to the bottom-right, with an arrow pointing up and to the left; a square with a diagonal line from the top-left to the bottom-right, with an arrow pointing up and to the right; a square with a diagonal line from the top-left to the bottom-right, with an arrow pointing up and to the left; a square with a diagonal line from the top-left to the bottom-right, with an arrow pointing up and to the right; a square with a diagonal line from the top-left to the bottom-right, with an arrow pointing up and to the left; a square with a diagonal line from the top-left to the bottom-right, with an arrow pointing up and to the right; a square with a diagonal line from the top-left to the bottom-right, with an arrow pointing up and to the left; a square with a diagonal line from the top-left to the bottom-right, with an arrow pointing up and to the right; a square with a diagonal line from the top-left to the bottom-right, with an arrow pointing up and to the left.</p>



ASL Bible Dictionary

Spoken Word	SignWriting
Nicolas	
Nicopolis	
NIDDM	
night	
night	
night	





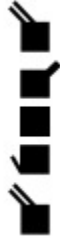

ASL Bible Dictionary

Spoken Word	SignWriting
night	<p>The sign for 'night' is composed of two parts: a hand sign with the index finger pointing up and the thumb pointing left, and a directional arrow pointing to the right.</p>
Nile	<p>The sign for 'Nile' is a vertical sequence of four hand signs: a hand with the index finger pointing up, a hand with the index finger pointing down, a hand with the index finger pointing left, and a hand with the index finger pointing right.</p>
Nimrod	<p>The sign for 'Nimrod' is a vertical sequence of five hand signs: a hand with the index finger pointing up, a hand with the index finger pointing down, a hand with the index finger pointing left, a hand with the index finger pointing right, and a hand with the index finger pointing up.</p>
Nine	<p>The sign for 'Nine' is a hand sign with the index finger pointing up and the thumb pointing left.</p>
Nineveh	<p>The sign for 'Nineveh' is a hand sign with the index finger pointing up and the thumb pointing left, followed by a curved arrow pointing to the right.</p>
Nineveh	<p>The sign for 'Nineveh' is a vertical sequence of seven hand signs: a hand with the index finger pointing up, a hand with the index finger pointing down, a hand with the index finger pointing left, a hand with the index finger pointing right, a hand with the index finger pointing up, a hand with the index finger pointing down, and a hand with the index finger pointing left.</p>

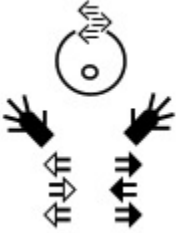
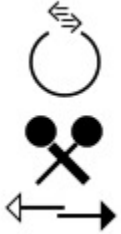

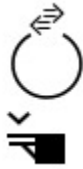

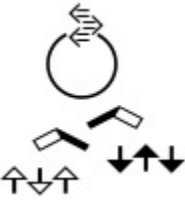

ASL Bible Dictionary

Spoken Word	SignWriting
Nisan	 A vertical sequence of six handshapes: a fist with the index finger pointing up, a fist with the index finger pointing down, a fist with the index finger pointing up, a fist with the index finger pointing down, a fist with the index finger pointing up, and a fist with the index finger pointing down.
no	 A handshape consisting of a fist with the index finger pointing down and a small 'v' shape above it.

ASL Bible Dictionary

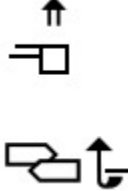
Spoken Word	SignWriting
No	
no	
no	
no	
no-good	
no-matter	
no-matter	
no-matter	

ASL Bible Dictionary

Spoken Word	SignWriting
Noah	
Noah	
Nob	
noble	
nobles	
nod	
Nod	







ASL Bible Dictionary

Spoken Word	SignWriting
nomads	<p>The sign for 'nomads' is a vertical sequence of six symbols: a hand with fingers spread, a solid black circle, a hand with fingers spread, a solid black circle, a hand with fingers spread, and a solid black circle.</p>
none	<p>The sign for 'none' consists of a diagonal line above two solid black circles, with a left-pointing arrow to the left and a right-pointing arrow to the right.</p>
none	<p>The sign for 'none' consists of two solid black circles with a left-pointing arrow to the left and a right-pointing arrow to the right.</p>
none	<p>The sign for 'none' consists of a circular arrow pointing clockwise above two solid black circles that are crossed by an 'X', with a left-pointing arrow to the left and a right-pointing arrow to the right.</p>
none	<p>The sign for 'none' consists of two solid black circles with a left-pointing arrow to the left and a right-pointing arrow to the right.</p>
none	<p>The sign for 'none' consists of an upward-pointing arrow above a solid black circle.</p>
none	<p>The sign for 'none' consists of two upward-pointing arrows above two solid black circles.</p>
none	<p>The sign for 'none' consists of two arrows pointing diagonally upwards and outwards above two solid black circles.</p>
none	<p>The sign for 'none' is empty.</p>
noon	<p>The sign for 'noon' consists of a solid black arrow pointing upwards above a solid black arrow pointing to the right.</p>

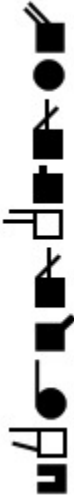
ASL Bible Dictionary

Spoken Word	SignWriting
noon	<p>The sign for 'noon' is composed of two parts. The first part shows a horizontal line with a square on the left and an arrow pointing right. The second part shows a vertical line with a square on the left and an arrow pointing up.</p>
North	<p>The sign for 'North' consists of two parallel vertical arrows pointing upwards, positioned above a square with a diagonal line extending from the top-left corner.</p>
north	<p>The sign for 'north' is identical to the sign for 'North', consisting of two parallel vertical arrows pointing upwards above a square with a diagonal line.</p>
northeaster	<p>The sign for 'northeaster' is a vertical sequence of eight distinct symbols: a square with a diagonal line, a solid circle, a square with a diagonal line, a square with a horizontal line extending to the left, a square with a horizontal line extending to the right, a square with a horizontal line extending to the right, a square with a horizontal line extending to the right, and a square with a diagonal line.</p>







ASL Bible Dictionary

Spoken Word	SignWriting
Northridge	
northwest	
nose	
not	
not	
not	

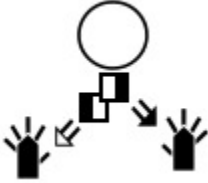
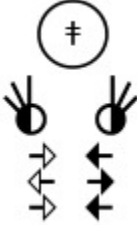

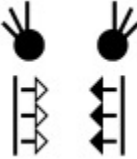

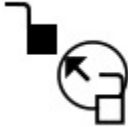
ASL Bible Dictionary

Spoken Word	SignWriting
not	<p>The signwriting for 'not' consists of a circle with a hand icon on top, a vertical line with a hand icon on the left, and a diagonal line with a hand icon on the right.</p>
not understand	<p>The signwriting for 'not understand' consists of a circle with a hand icon on top, a vertical line with a hand icon on the left, and a small circle with a hand icon on the right.</p>
not-have	<p>The signwriting for 'not-have' consists of a circle with a hand icon on top, a vertical line with a hand icon on the left, and two diagonal lines with hand icons on the right, with two asterisks below them.</p>
not-responsible	<p>The signwriting for 'not-responsible' consists of a horizontal line with a hand icon on the left, a vertical line with a hand icon on the right, and two diagonal lines with hand icons on the right.</p>
not-understand	<p>The signwriting for 'not-understand' consists of a circle with a hand icon on top, a vertical line with a hand icon on the left, and a small circle with a hand icon on the right.</p>
not-yet	<p>The signwriting for 'not-yet' consists of a circle with a hand icon on top, a vertical line with a hand icon on the right, and a horizontal line with a hand icon on the right.</p>
nothing	<p>The signwriting for 'nothing' consists of a circle with a hand icon on top, a vertical line with a hand icon on the left, and two diagonal lines with hand icons on the right.</p>



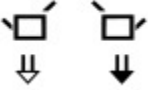
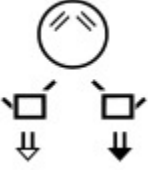
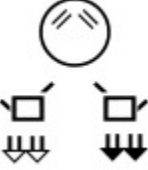

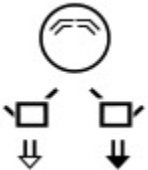
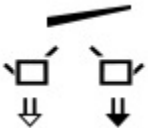
ASL Bible Dictionary

Spoken Word	SignWriting
nothing	
nothing	
nothing-to-do-with	
nothing-to-it	
notice	
notice	
notice	
November	



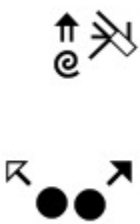

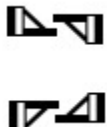

ASL Bible Dictionary

Spoken Word	SignWriting
now	
now	
now	
now	
now	
now	
NTD	



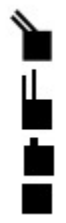

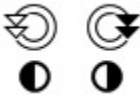

ASL Bible Dictionary

Spoken Word	SignWriting
nuclear	
numb	
numb	
number	
nurse	
nurse	

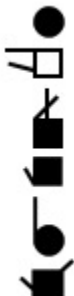
ASL Bible Dictionary

Spoken Word	SignWriting
nursing	
nut	
nuts	
Nympha	
O	
O	
O'Grady	

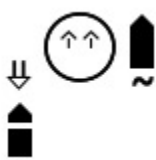
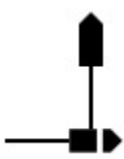









ASL Bible Dictionary

Spoken Word	SignWriting
O'Grady	
o-f	
o-r	
oak	
oath	
oath	
Obadiah	

ASL Bible Dictionary

Spoken Word	SignWriting
Obal	<p>The signwriting for 'Obal' consists of a vertical sequence of symbols: a solid black circle at the top, followed by a solid black arrow pointing up, then a solid black arrow pointing down, and finally a solid black horizontal line.</p>
Obed	<p>The signwriting for 'Obed' consists of a vertical sequence of symbols: a solid black circle at the top, followed by a solid black arrow pointing up, then a solid black arrow pointing down, and finally a solid black hook-like shape at the bottom.</p>
obey	<p>The signwriting for 'obey' features a central circle with a downward-pointing arrow above it. To the left and right of the circle are two squares, each with a downward-pointing arrow below it. Below each square is a hand icon with fingers spread, representing the hands used to sign the word.</p>
obey	<p>The signwriting for 'obey' features a circle on the left with a downward-pointing arrow above it. To its right are two squares, with a downward-pointing arrow below them. Below the squares are two hand icons with fingers spread.</p>
obey	<p>The signwriting for 'obey' features two squares on the left with a downward-pointing arrow below them. To their right is a circle with a downward-pointing arrow above it. Below the squares are two hand icons with fingers spread.</p>
object	<p>The signwriting for 'object' consists of a hand icon with fingers spread, with a downward-pointing arrow below it.</p>







ASL Bible Dictionary

Spoken Word	SignWriting
Oct	
odd	
odious woman	
of	
of	
of	
of	
of	
of	
of-course	

ASL Bible Dictionary

Spoken Word	SignWriting
of-course	<p>The SignWriting for 'of-course' consists of four symbols arranged vertically. From top to bottom: a circle with two short horizontal lines inside; a circle with a curved arrow pointing to the right; a square with a diagonal line from the top-left to the bottom-right; and a square with a diagonal line from the top-right to the bottom-left.</p>
off	<p>The SignWriting for 'off' consists of three symbols arranged vertically. Each symbol is a solid black circle with three short lines extending downwards from its center, representing a hand with fingers pointing down.</p>

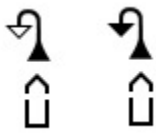

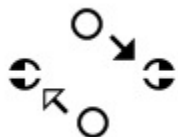



ASL Bible Dictionary

Spoken Word	SignWriting
off-cross	
offense	
offense	
offer	
offer	
offered	
offerings	
office	





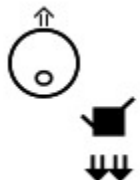



ASL Bible Dictionary

Spoken Word	SignWriting
officer	<p>The SignWriting for 'officer' consists of a vertical sequence of seven symbols: a solid black circle, a circle with three lines radiating from the top-right, a circle with three lines radiating from the top-left, a square with a diagonal line from the top-left to the bottom-right, a square with a diagonal line from the top-right to the bottom-left, a square with a diagonal line from the top-left to the bottom-right, and a solid black square.</p>
officers	<p>The SignWriting for 'officers' is identical to the SignWriting for 'officer', consisting of a vertical sequence of seven symbols: a solid black circle, a circle with three lines radiating from the top-right, a circle with three lines radiating from the top-left, a square with a diagonal line from the top-left to the bottom-right, a square with a diagonal line from the top-right to the bottom-left, a square with a diagonal line from the top-left to the bottom-right, and a solid black square.</p>
official	<p>The SignWriting for 'official' consists of two symbols: an upward-pointing arrow above a square with a diagonal line from the top-left to the bottom-right.</p>
official	<p>The SignWriting for 'official' consists of a horizontal line, a circle with a horizontal line through its center, and two asterisks (**).</p>
official	<p>The SignWriting for 'official' consists of four symbols arranged in a 2x2 grid. The top-left symbol is a square with a diagonal line from the top-left to the bottom-right and an upward-pointing arrow below it. The top-right symbol is a square with a diagonal line from the top-right to the bottom-left and a downward-pointing arrow below it. The bottom-left symbol is a square with a diagonal line from the top-left to the bottom-right and a downward-pointing arrow below it. The bottom-right symbol is a square with a diagonal line from the top-right to the bottom-left and an upward-pointing arrow below it.</p>

ASL Bible Dictionary

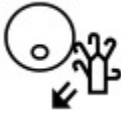
Spoken Word	SignWriting
officials	
officials	
often	
Og	
oh	
oh	
oh	
oh	



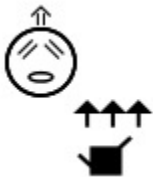

ASL Bible Dictionary

Spoken Word	SignWriting
oh	
oh	
oh	
oh	
oh	
oh	
oh	
oh	
oh-I-see	



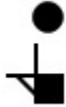

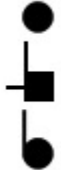
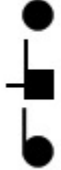
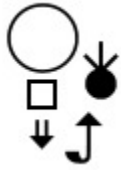

ASL Bible Dictionary

Spoken Word	SignWriting
oh-I-see	<p>The signwriting for 'oh-I-see' consists of a face with an upward-pointing arrow above it, and a hand with three upward-pointing arrows above it.</p>
oh-well	<p>The signwriting for 'oh-well' consists of a face, two circular arrows, two solid black circles, and two hands with downward-pointing arrows above them.</p>
Ohad	<p>The signwriting for 'Ohad' consists of a solid black circle, a hand with a downward-pointing arrow, and another solid black circle.</p>
oil	<p>The signwriting for 'oil' consists of a hand with a downward-pointing arrow, a plus sign, a hand with a downward-pointing arrow, a hand with a downward-pointing arrow, and a hand with a downward-pointing arrow.</p>
oil	<p>The signwriting for 'oil' consists of a hand with a downward-pointing arrow, a hand with a downward-pointing arrow, a hand with a downward-pointing arrow, and a hand with a downward-pointing arrow.</p>
oil	<p>The signwriting for 'oil' consists of a hand with a downward-pointing arrow, a hand with a downward-pointing arrow, and a hand with a downward-pointing arrow.</p>



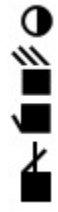



ASL Bible Dictionary

Spoken Word	SignWriting
okay	
old	
old	
old	
old	
Old	
old-6	

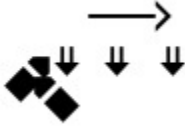
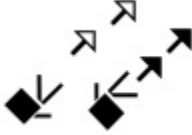
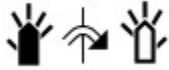







ASL Bible Dictionary

Spoken Word	SignWriting
Olympas	
olympics	
Omar	
Omar	
Omega	
On	
on	



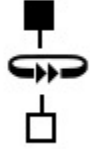

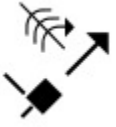
ASL Bible Dictionary

Spoken Word	SignWriting
on	
on	
on-other-hand	
Onam	
Onan	
once	
once	
one	





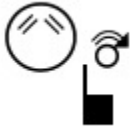

ASL Bible Dictionary

Spoken Word	SignWriting
One	
one	
one	
one	
one	
one-another	
one-another	
one-by-one	
one-emph	





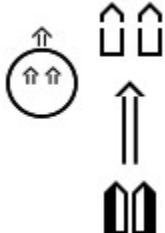

ASL Bible Dictionary

Spoken Word	SignWriting
Onesimus	
Onesiphorus	
only	
only	
only	
Ono	



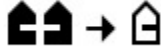

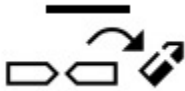
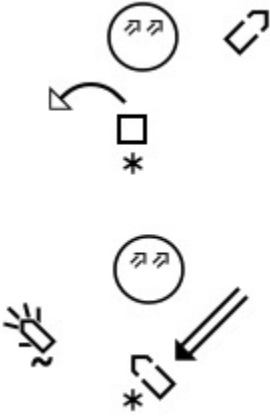
ASL Bible Dictionary

Spoken Word	SignWriting
onyx	
oops	
oops	
open	
open	
open	
open	
open-Bible	



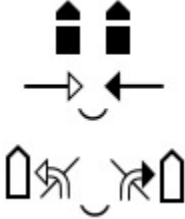

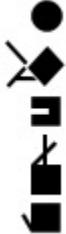

ASL Bible Dictionary

Spoken Word	SignWriting
open-box	
open-door	
open-door	
open-eyes	
open-heart	
open-heart	
open-mouth	
open-open	





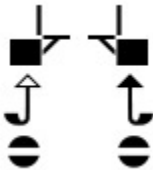
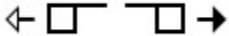

ASL Bible Dictionary

Spoken Word	SignWriting
opened	 <p>The signwriting for 'opened' in the top row consists of two black house-shaped icons with pointed roofs, positioned side-by-side. Below them are two horizontal arrows pointing towards each other, with a small curved line underneath them. At the bottom are two more house-shaped icons, each with a curved arrow above it pointing towards the center.</p>
opened	 <p>The signwriting for 'opened' in the middle row consists of three house-shaped icons in a row. The middle icon is solid black, while the two side icons are white with black outlines. Curved arrows above the side icons point towards the middle icon. Below this row is another row of three house-shaped icons, with the middle one solid black and the side ones white with black outlines. Curved arrows above the side icons point towards the middle icon.</p>
opera	 <p>The signwriting for 'opera' is a vertical sequence of symbols: a solid black circle at the top, followed by a black diamond shape, then a black square, then a black cross, and finally a black square at the bottom.</p>
operate	 <p>The signwriting for 'operate' consists of a black diamond shape on the left and a black square on the right. Two arrows originate from the top of the square and point towards the diamond.</p>

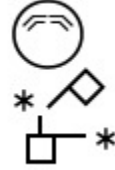

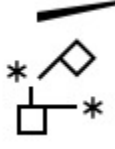

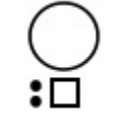
ASL Bible Dictionary

Spoken Word	SignWriting
Ophel	
Ophir	
opinion	
opinion	
opportunity	
opposite	
oppress	
oppress	



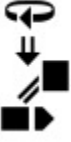

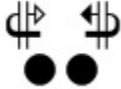
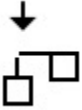



ASL Bible Dictionary

Spoken Word	SignWriting
or	
or	
or	
or	
or-tl	
oral	
orange	
orders	

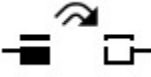



ASL Bible Dictionary

Spoken Word	SignWriting
ordinary	
ordinary	
org	
organ	
organization	
original	
Orion	
Orpah	



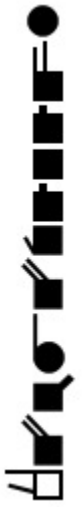

ASL Bible Dictionary

Spoken Word	SignWriting
orphan	
other	
other	
otherwise	
ought-to	
ounce	
our	
our	
our	
our weapons	







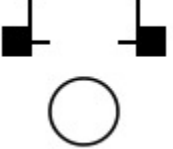
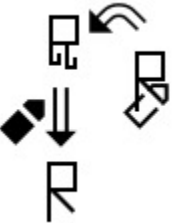
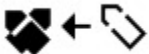

ASL Bible Dictionary

Spoken Word	SignWriting
out	
out	
Out	
outside	
outside	
outstanding	





ASL Bible Dictionary

Spoken Word	SignWriting
oven	
oven	
Ovens	
over	
over	
over-head	
overboard	
overlap	



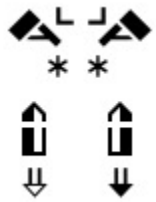
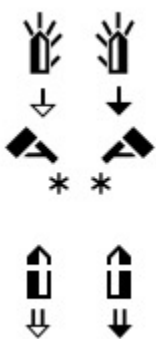

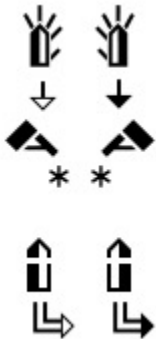

ASL Bible Dictionary

Spoken Word	SignWriting
overlook	
overwhelm	
overwhelm	
owe	
own	
own	
own	
owner	





ASL Bible Dictionary

Spoken Word	SignWriting
owner	
owner	
owner	
owners	
owners	

ASL Bible Dictionary

Spoken Word	SignWriting
ox	
oxygen	
P	
PA	
Pacific	
pacify	
pack	



ASL Bible Dictionary

Spoken Word	SignWriting
<p>Padanaram</p>	
<p>Padden</p>	
<p>Padden</p>	
<p>Padon</p>	

ASL Bible Dictionary

Spoken Word	SignWriting
paedisk	<p>The signwriting for 'paedisk' consists of a vertical sequence of symbols: a diamond with a diagonal slash, a square with a diagonal slash, a horizontal line, a circle, a vertical line, a square, and a vertical line with a horizontal tick at the bottom.</p>
pagan	<p>The signwriting for 'pagan' consists of a vertical sequence of symbols: a diamond with a diagonal slash, a square with a diagonal slash, a square with a horizontal line, a square, and a vertical line with a horizontal tick at the bottom.</p>
page	<p>The signwriting for 'page' consists of a diamond with a diagonal slash, a square with a diagonal slash, and a square with a horizontal line.</p>
pages	<p>The signwriting for 'pages' consists of a diamond with a diagonal slash, a square with a diagonal slash, and a square with a horizontal line.</p>
pah	<p>The signwriting for 'pah' consists of a circle with a downward arrow, a small square, and a small circle.</p>
pah	<p>The signwriting for 'pah' consists of a circle with a downward arrow, a small square, a small circle, and a vertical line with a horizontal tick at the bottom.</p>



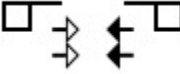
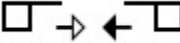

ASL Bible Dictionary

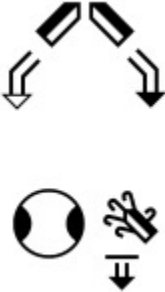
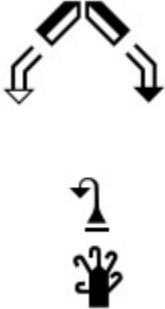
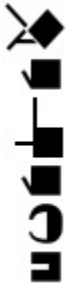
Spoken Word	SignWriting
Pahath-moab	 <p>A vertical sequence of eight hand-drawn symbols representing the sign for 'Pahath-moab'. From top to bottom: a diamond with a diagonal line, a square with a horizontal line, a square with a horizontal line and a vertical line extending to the left, a square with a horizontal line, a square with a horizontal line and a vertical line extending to the right, a square with a horizontal line, a solid circle, and a square with a horizontal line.</p>
Pahathmoab	 <p>A vertical sequence of eight hand-drawn symbols representing the sign for 'Pahathmoab'. From top to bottom: a diamond with a diagonal line, a square with a horizontal line, a square with a horizontal line and a vertical line extending to the left, a square with a horizontal line, a square with a horizontal line and a vertical line extending to the right, a square with a horizontal line, a solid circle, and a square with a horizontal line.</p>
paid-off	 <p>Two hand-drawn symbols representing the sign for 'paid-off'. The top symbol shows a hand with fingers spread and an arrow pointing down and to the left. The bottom symbol shows a hand with fingers spread and an arrow pointing up and to the right.</p>
pain	 <p>Two hand-drawn symbols representing the sign for 'pain'. Each symbol consists of a square with a horizontal line and a vertical line extending to the right, with an arrow pointing to the right from the vertical line.</p>
pain	 <p>Two hand-drawn symbols representing the sign for 'pain'. Each symbol consists of a square with a horizontal line and a vertical line extending to the left, with an arrow pointing to the left from the vertical line.</p>

ASL Bible Dictionary

Spoken Word	SignWriting
paint	
palace	
palace	
palace	







ASL Bible Dictionary

Spoken Word	SignWriting
palmface game	
Pam	
Pamphylia	
pancreas	
panel	



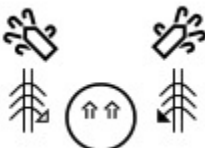

ASL Bible Dictionary

Spoken Word	SignWriting
panic	The SignWriting for 'panic' consists of a circle with a horizontal line above it, representing the head. Below the head are two vertical lines representing shoulders. From each shoulder, a vertical line descends to a horizontal line, representing the arms. From each of these horizontal lines, two arrows point outwards and downwards, representing the hands.
pants	The SignWriting for 'pants' consists of two horizontal lines at the top, representing the waistband. Below these are two vertical lines representing the legs. At the bottom of each leg, there are two arrows pointing downwards and outwards, representing the feet. A single arrow points to the right below the space between the two legs.

ASL Bible Dictionary

Spoken Word	SignWriting
paralyzed	
paramedic	
paramedic	
Paramedic	
Paran	
parents	
parents	



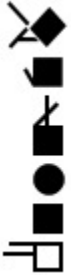
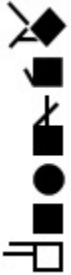
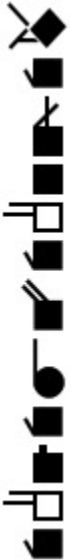

ASL Bible Dictionary

Spoken Word	SignWriting
Paris	
Paris	
park	
Parmashta	
Parmenas	

ASL Bible Dictionary

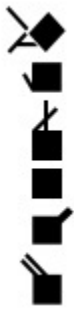
Spoken Word	SignWriting
Parnel	
Parosh	
Parosh	
Parshandatha	

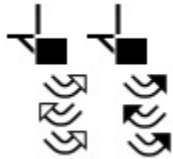



ASL Bible Dictionary

Spoken Word	SignWriting
Parsin	
Parthians	
particles	
parties	
partner	
partner	

ASL Bible Dictionary

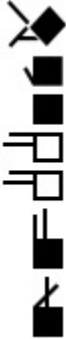
Spoken Word	SignWriting
partners	<p>The signwriting for 'partners' consists of three distinct parts. The top part shows a hand with fingers spread, moving from a high position down and to the right, with arrows indicating the path. The middle part shows two hands, each with fingers spread, moving from a high position down and to the right, with arrows indicating the path. The bottom part shows two hands, each with fingers spread, moving from a high position down and to the right, with arrows indicating the path.</p>
parts	<p>The signwriting for 'parts' consists of a single part showing a hand with fingers spread, moving from a high position down and to the right, with arrows indicating the path.</p>
parts	<p>The signwriting for 'parts' consists of a single part showing a hand with fingers spread, moving from a high position down and to the right, with arrows indicating the path.</p>
party	<p>The signwriting for 'party' consists of two parts. The top part shows two hands, each with fingers spread, moving from a high position down and to the right, with arrows indicating the path. The bottom part shows two hands, each with fingers spread, moving from a high position down and to the right, with arrows indicating the path.</p>
party	<p>The signwriting for 'party' consists of a single part showing a hand with fingers spread, moving from a high position down and to the right, with arrows indicating the path.</p>
Paseah	<p>The signwriting for 'Paseah' consists of a single part showing a hand with fingers spread, moving from a high position down and to the right, with arrows indicating the path.</p>

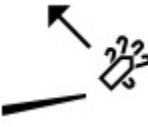
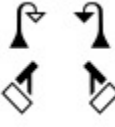
ASL Bible Dictionary

Spoken Word	SignWriting
Pashhur	
pass	
pass	
pass	
passes	
passing	
passion	

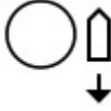
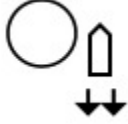
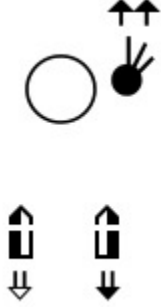
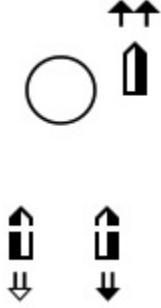
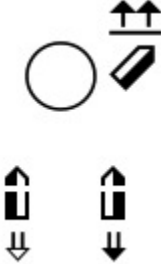

ASL Bible Dictionary

Spoken Word	SignWriting
Passover	
past	
past	
pastor	
pastor	
Pastor	



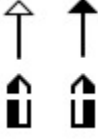

ASL Bible Dictionary

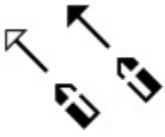
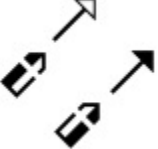
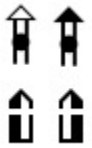
Spoken Word	SignWriting
Pastor Ron	<p>The signwriting for 'Pastor Ron' consists of a church icon, a circle with a dot inside, and an upward-pointing arrow. Below these is a hand icon with the index finger pointing up.</p>
Pastor Ron	<p>The signwriting for 'Pastor Ron' consists of a church icon, an upward-pointing arrow, and a hand icon with the index finger pointing up.</p>
pastors	<p>The signwriting for 'pastors' consists of a circle, two upward-pointing arrows, and two hand icons. Each hand icon has the index finger pointing up and the thumb pointing right.</p>
pastors	<p>The signwriting for 'pastors' consists of a circle, two upward-pointing arrows, a hand icon with the index finger pointing up and the thumb pointing right, and a hand icon with the index finger pointing up and the thumb pointing right.</p>
pasture	<p>The signwriting for 'pasture' consists of a hand icon with the index finger pointing up and the thumb pointing right, with the number '3' written above it. Below this is a hand icon with the index finger pointing up and the thumb pointing right, with a curved arrow above it.</p>





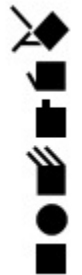

ASL Bible Dictionary

Spoken Word	SignWriting
Patara	
path	
path	
path	
path	
path-down	

ASL Bible Dictionary

Spoken Word	SignWriting
Pathrusim	
patience	
patient	
patient	
patient	
Patmos	

ASL Bible Dictionary

Spoken Word	SignWriting
pattern	
Pau	
Paul	
Paul	
Paul	
Paulus	
pause	

ASL Bible Dictionary

Spoken Word	SignWriting
peace	<p>The SignWriting for 'peace' consists of four sequential handshapes: 1. A hand with fingers curled and thumb extended. 2. A hand with fingers extended and thumb tucked. 3. A hand with fingers curled and thumb extended. 4. Two hands with fingers extended and thumbs tucked, moving outwards.</p>
peace	<p>The SignWriting for 'peace' consists of four sequential handshapes: 1. A hand with fingers curled and thumb extended. 2. A hand with fingers extended and thumb tucked. 3. A hand with fingers curled and thumb extended. 4. Two hands with fingers extended and thumbs tucked, moving outwards.</p>
pearl	<p>The SignWriting for 'pearl' consists of five sequential handshapes: 1. A hand with fingers curled and thumb extended. 2. A hand with fingers extended and thumb tucked. 3. A hand with fingers curled and thumb extended. 4. A hand with fingers extended and thumb tucked. 5. A hand with fingers curled and thumb extended.</p>
pearls	<p>The SignWriting for 'pearls' consists of five sequential handshapes: 1. A hand with fingers curled and thumb extended. 2. A hand with fingers extended and thumb tucked. 3. A hand with fingers curled and thumb extended. 4. A hand with fingers extended and thumb tucked. 5. A hand with fingers curled and thumb extended.</p>
Pedaiah	<p>The SignWriting for 'Pedaiah' consists of seven sequential handshapes: 1. A hand with fingers curled and thumb extended. 2. A hand with fingers extended and thumb tucked. 3. A hand with fingers curled and thumb extended. 4. A hand with fingers extended and thumb tucked. 5. A hand with fingers curled and thumb extended. 6. A hand with fingers extended and thumb tucked. 7. A hand with fingers curled and thumb extended.</p>

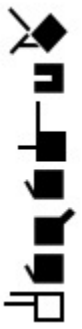
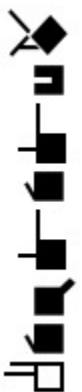
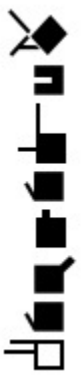
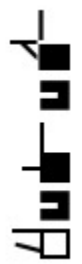

ASL Bible Dictionary

Spoken Word	SignWriting
Pelaiah	
Pelaliah	
Pelatiah	
Peleg	



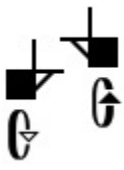
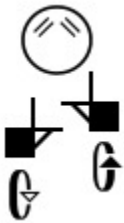
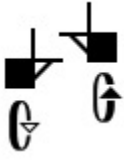
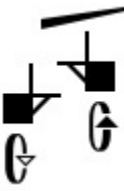
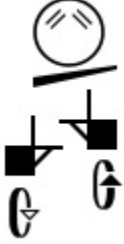
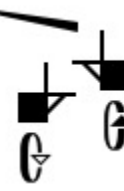

ASL Bible Dictionary

Spoken Word	SignWriting
pen	<p>The SignWriting for 'pen' consists of two parts. The first part is a circle with a small square at the top right, connected by a line. The second part is a rectangle with a small square at the bottom right, connected by a line, and an arrow pointing up and to the right.</p>
Peniel	<p>The SignWriting for 'Peniel' is a vertical sequence of seven symbols: a diamond with a diagonal line, a square with a horizontal line, a square with a diagonal line, a square with a horizontal line, a square with a diagonal line, a square with a horizontal line, and a square with a horizontal line.</p>
peninsula	<p>The SignWriting for 'peninsula' is a vertical sequence of seven symbols: a diamond with a diagonal line, a square with a horizontal line, a square with a diagonal line, a square with a horizontal line, a square with a diagonal line, a square with a horizontal line, and a square with a horizontal line.</p>
peninsula	<p>The SignWriting for 'peninsula' consists of two parts. The first part is a square with a horizontal line, connected by a line to a diamond with a diagonal line. The second part is a square with a horizontal line, connected by a line to a diamond with a diagonal line.</p>
Pennsylvania	<p>The SignWriting for 'Pennsylvania' is a vertical sequence of seven symbols: a diamond with a diagonal line, a square with a horizontal line, a square with a diagonal line, a square with a horizontal line, a square with a diagonal line, a square with a horizontal line, and a square with a diagonal line.</p>





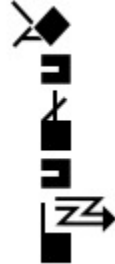
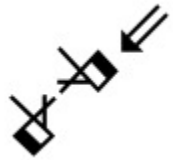

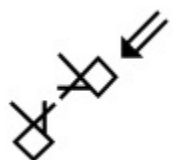
ASL Bible Dictionary

Spoken Word	SignWriting
people	
people	
people	
people	
people	
people	
people-packed	

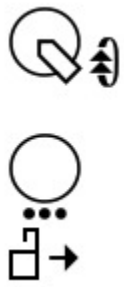
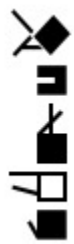



ASL Bible Dictionary

Spoken Word	SignWriting
perceive	
percent	
perdition	
Perez	
perfect	
perfect	
perfect	



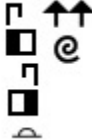

ASL Bible Dictionary

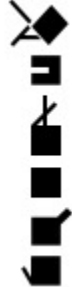
Spoken Word	SignWriting
perfume	
Perga	
Pergamum	
perhaps	
period	
period	
period	
period	

ASL Bible Dictionary

Spoken Word	SignWriting
Perizzites	
perplex	
perplexed	
persecute	
persecuted	
Persia	

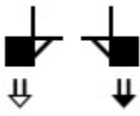
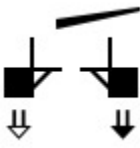
ASL Bible Dictionary

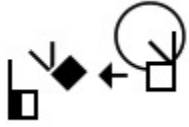
Spoken Word	SignWriting
Persian	
Persis	
person	
person	
personality	
perspective	



ASL Bible Dictionary

Spoken Word	SignWriting
persuade	<p>The signwriting for 'persuade' consists of three main components: a square with a small square inside, a downward-pointing arrow, and another square with a small square inside.</p>
Peruda	<p>The signwriting for 'Peruda' is a vertical sequence of symbols: a diamond with a diagonal line, a square with a horizontal line, a square with a horizontal line, a circle, and a square with a horizontal line.</p>
Pesaiah	<p>The signwriting for 'Pesaiah' is a vertical sequence of symbols: a diamond with a diagonal line, a square with a horizontal line, a circle, a square with a horizontal line, and a square with a horizontal line.</p>
pestilence	<p>The signwriting for 'pestilence' is a vertical sequence of symbols: a circle with a hand pointing to it, a hand with a star below it, two hands with fingers spread, a square with a horizontal line, and a square with a horizontal line.</p>

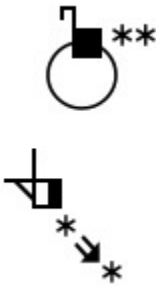
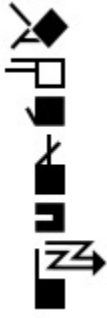
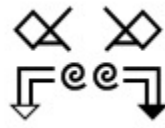

ASL Bible Dictionary

Spoken Word	SignWriting
petitions	<p>The SignWriting for 'petitions' consists of two parts: a book icon (two vertical bars with a central gap) and a hand icon (a stylized hand with fingers spread).</p>
Phallu	<p>The SignWriting for 'Phallu' is a vertical sequence of six symbols: a diamond with a diagonal slash, a square with a vertical line, a square with a horizontal line, a square with a vertical line, a square with a horizontal line, and a square with a horizontal line.</p>
Phallu	<p>The SignWriting for 'Phallu' is a vertical sequence of six symbols: a diamond with a diagonal slash, a square with a vertical line, a square with a horizontal line, a square with a vertical line, a square with a horizontal line, and a square with a horizontal line.</p>
Phanuel	<p>The SignWriting for 'Phanuel' is a vertical sequence of seven symbols: a diamond with a diagonal slash, a square with a vertical line, a square with a horizontal line, a square with a vertical line, a square with a horizontal line, a square with a horizontal line, and a square with a horizontal line.</p>

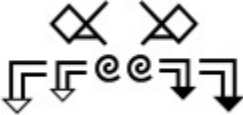

ASL Bible Dictionary

Spoken Word	SignWriting
Pharaoh	 <p>A vertical sequence of six signs: a diamond with a diagonal line, a square with a horizontal line, a square with a vertical line, a square with a diagonal line, a solid black circle, and a square with a horizontal line.</p>
Pharaoh	 <p>Two signs: the first is a square with a horizontal line inside a circle, followed by two asterisks; the second is a square with a horizontal line and a diagonal line, followed by three asterisks.</p>
Pharez	 <p>A vertical sequence of six signs: a diamond with a diagonal line, a square with a horizontal line, a square with a vertical line, a square with a diagonal line, a square with a horizontal line, and a square with a horizontal line and a zigzag arrow pointing right.</p>
Pharisee	 <p>Two signs: the first is a diamond with a diagonal line and a horizontal line, with an arrow pointing down; the second is a diamond with a diagonal line and a horizontal line, with an arrow pointing down.</p>
Pharisee	 <p>A vertical sequence of six signs: a diamond with a diagonal line, a square with a horizontal line, a square with a vertical line, a square with a diagonal line, a square with a horizontal line, and a square with a horizontal line.</p>

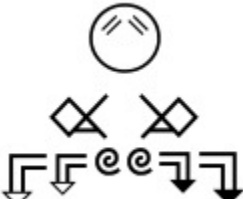
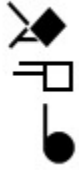
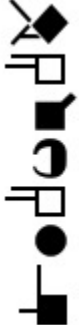

ASL Bible Dictionary

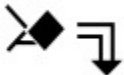
Spoken Word	SignWriting
Pharisees	
Pharisees	
Pharisees	
PhD	
Phichol	

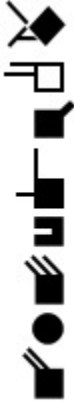

ASL Bible Dictionary

Spoken Word	SignWriting
Phil.	
Phil03v13	
Philadelphia	
Philadelphia	
Philemon	

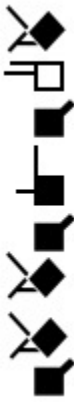

ASL Bible Dictionary

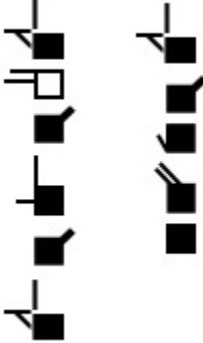
Spoken Word	SignWriting
Philemon	
Philetus	
Philip	
Philippi	



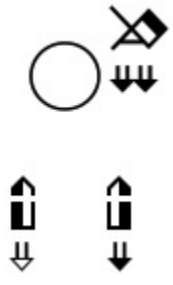

ASL Bible Dictionary

Spoken Word	SignWriting
Philippians	
Philippians	
Philistia	
Philistim	

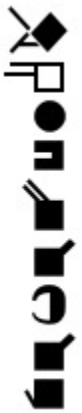

ASL Bible Dictionary

Spoken Word	SignWriting
Philistines	
Philistines	
Philologus	
philosopher	



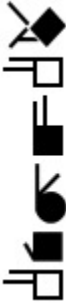
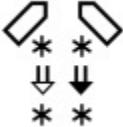

ASL Bible Dictionary

Spoken Word	SignWriting
Phoenicia	
Phoenix	
phony	
phrase	
Phrygia	

ASL Bible Dictionary

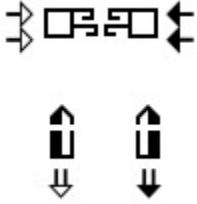
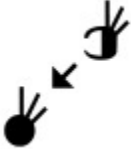
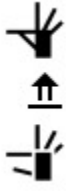
Spoken Word	SignWriting
Phut	
Phuvah	
physical	
physical	
physician	

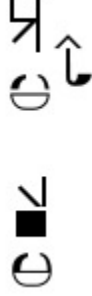
ASL Bible Dictionary

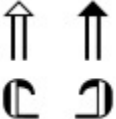
Spoken Word	SignWriting
physicist	
pick	
pick	
pick-up	
pick-up	
pick-up	
pick-up-cross	





ASL Bible Dictionary

Spoken Word	SignWriting
pick-up-jar	<p>The signwriting for 'pick-up-jar' consists of three parts: a circle with two diagonal lines inside, two curved arrows pointing up and outwards, and two curved arrows pointing down and inwards.</p>
pick-up-mat	<p>The signwriting for 'pick-up-mat' consists of two hand symbols with fingers spread, and two upward-pointing arrows.</p>
pick-up-stones	<p>The signwriting for 'pick-up-stones' consists of a hand symbol holding a stone, and three curved arrows pointing up and outwards.</p>



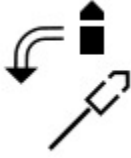

ASL Bible Dictionary

Spoken Word	SignWriting
picture	<p>The sign for 'picture' is composed of two parts: a circle with a horizontal line through its center, and a hand sign with the index finger pointing down.</p>
pictures	<p>The sign for 'pictures' is composed of two parts: a circle with a horizontal line through its center, and a hand sign with the index finger pointing down and a small vertical line above it.</p>
pidgin	<p>The sign for 'pidgin' is composed of four parts: a diamond with a diagonal line, a hand sign with the index finger pointing up, a hand sign with the index finger pointing right, and a hand sign with the index finger pointing down.</p>
pidgin	<p>The sign for 'pidgin' is composed of four parts: a diamond with a diagonal line, a hand sign with the index finger pointing up, a hand sign with the index finger pointing right, and a hand sign with the index finger pointing down.</p>
piece	<p>The sign for 'piece' is composed of two parts: a hand sign with the index finger pointing up and the thumb pointing right, and two asterisks below it.</p>
Pierce	<p>The sign for 'Pierce' is composed of four parts: a diamond with a diagonal line, a hand sign with the index finger pointing up, a hand sign with the index finger pointing right, and a hand sign with the index finger pointing down.</p>



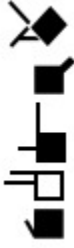

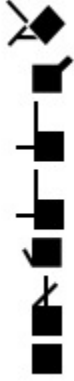
ASL Bible Dictionary

Spoken Word	SignWriting
pile	
pile	
Pilgrim	
Pilgrim	
Pilgrims	

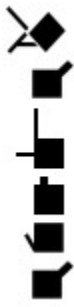
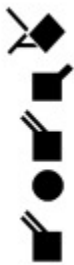

ASL Bible Dictionary

Spoken Word	SignWriting
Pilha	
pill	
pillar	
pillars	
pillows	

ASL Bible Dictionary

Spoken Word	SignWriting
Piltai	
Pinon	
pioneer	
pipes	
pipes	

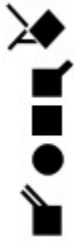
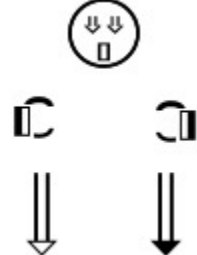
ASL Bible Dictionary

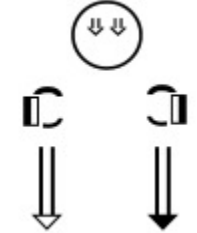
Spoken Word	SignWriting
Pisidia	
Pison	
pit	
pit	
pit	



ASL Bible Dictionary

Spoken Word	SignWriting
pitch	<p>The SignWriting for 'pitch' consists of a vertical sequence of five symbols: a diamond with a diagonal line, a square with a diagonal line, a square with a diagonal line, a square with a diagonal line, and a square with a diagonal line.</p>
Pithom	<p>The SignWriting for 'Pithom' consists of a vertical sequence of six symbols: a diamond with a diagonal line, a square with a diagonal line, a square with a diagonal line, a square with a diagonal line, a circle, and a hand with fingers spread.</p>
Pittsburgh	<p>The SignWriting for 'Pittsburgh' consists of a vertical sequence of ten symbols: a diamond with a diagonal line, a square with a diagonal line, a square with a diagonal line, a square with a diagonal line, a square with a diagonal line, a square with a diagonal line, a square with a diagonal line, a square with a diagonal line, a square with a diagonal line, and a square with a diagonal line.</p>
pity	<p>The SignWriting for 'pity' consists of two symbols: a hand with fingers spread and a diamond with a diagonal line.</p>
pizza	<p>The SignWriting for 'pizza' consists of two symbols: a square with a diagonal line and a square with a diagonal line.</p>
place	<p>The SignWriting for 'place' consists of two symbols: a square with a diagonal line and a square with a diagonal line.</p>

ASL Bible Dictionary

Spoken Word	SignWriting
plague	<p>The sign for 'plague' is composed of several elements: a circle with a hand pointing to the right, a hand pointing to the left with an asterisk below it, two hands pointing towards each other, and two hands pointing downwards.</p>
plagues	<p>The sign for 'plagues' is a vertical sequence of signs: a hand pointing to the right, a hand pointing to the left, a hand pointing to the right, a hand pointing to the left, a hand pointing to the right, and a hand pointing to the left.</p>
plain	<p>The sign for 'plain' is a vertical sequence of signs: a hand pointing to the right, a hand pointing to the left, a hand pointing to the right, a hand pointing to the left, and a hand pointing to the right.</p>
plain	<p>The sign for 'plain' is composed of a circle with a hand pointing to the right, an upward-pointing arrow, and two hands pointing downwards.</p>
plainly	<p>The sign for 'plainly' is composed of two hands pointing towards each other, two hands pointing away from each other, and two hands pointing downwards.</p>
plains	<p>The sign for 'plains' is composed of two hands pointing to the right, two hands pointing to the left, and two hands pointing downwards.</p>

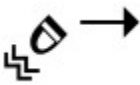
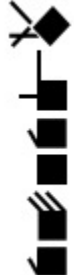
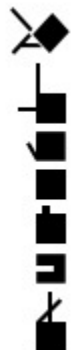
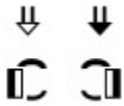
ASL Bible Dictionary

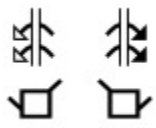
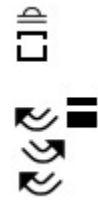
Spoken Word	SignWriting
plant	
plasma	
plaster	
plate	
plate	
play	
play	

ASL Bible Dictionary

Spoken Word	SignWriting
players	<p>The sign for 'players' is composed of four distinct signs arranged in a 2x2 grid. The top row consists of two identical signs, each featuring a square with a diagonal line from the top-left to the bottom-right. The bottom row consists of two identical signs, each featuring a vertical bar with a horizontal line extending to the right from its base, and a small arrow pointing down from the top of the vertical bar.</p>
plaza	<p>The sign for 'plaza' is composed of three signs. The top row has two identical signs, each showing a diamond shape with a diagonal line from the top-left to the bottom-right. The middle row has two identical signs, each showing a square with a horizontal line across its center and a small arrow pointing to the right from the center of the line. The bottom row has two identical signs, each showing a circular arrow pointing clockwise and a hand with fingers spread.</p>
plea	<p>The sign for 'plea' is composed of three signs. The first sign is a circle with a horizontal line across its top. The second and third signs are identical, each showing a hand with fingers spread and a small arrow pointing to the right.</p>
plea	<p>The sign for 'plea' is composed of three signs. The first sign is a circle with a horizontal line across its top and a horizontal line across its middle. The second and third signs are identical, each showing a hand with fingers spread and a small arrow pointing to the right.</p>
plead	<p>The sign for 'plead' is composed of two signs. The first sign is a circle with a horizontal line across its top. The second sign is a hand with fingers spread, with a small arrow pointing down from the center of the hand, and a book icon below it.</p>
pleasant	<p>The sign for 'pleasant' is composed of two signs. The first sign is a circle with a horizontal line across its top. The second sign is a hand with fingers spread, with a small arrow pointing to the right from the center of the hand.</p>
please	<p>The sign for 'please' is composed of one sign: a hand with fingers spread, with a small arrow pointing to the right from the center of the hand.</p>
please	<p>The sign for 'please' is composed of two signs. The first sign is a hand with fingers spread, with a small arrow pointing to the right from the center of the hand. The second sign is a circular arrow pointing clockwise.</p>

ASL Bible Dictionary

Spoken Word	SignWriting
please	
pleases	
Pleiades	
plenty	
plow	
plumb	





ASL Bible Dictionary

Spoken Word	SignWriting
plunge	<p>The sign for 'plunge' is represented by a small black square above a white square, with a downward-pointing arrow to the right of the white square.</p>
Plymouth	<p>The sign for 'Plymouth' is a vertical sequence of eight distinct symbols: a diamond with a diagonal slash, a square with a horizontal line, a square with a diagonal slash, a square with a diagonal slash, a solid black circle, a square with a horizontal line, a square with a diagonal slash, and a square with a diagonal slash.</p>
poem	<p>The sign for 'poem' consists of a white square with a diagonal slash, a curved arrow pointing right, and a black diamond.</p>
poet	<p>The sign for 'poet' consists of a white square with a diagonal slash, a curved arrow pointing right, a black diamond, and two vertical double-headed arrows.</p>
point-out	<p>The sign for 'point-out' consists of two hands with fingers spread, a curved arrow pointing right, a white square with a diagonal slash, a white square with a diagonal slash, and a white square with a diagonal slash and an upward-pointing arrow.</p>
poison	<p>The sign for 'poison' consists of a white square with a diagonal slash, a curved arrow pointing right, and a black arrow pointing right.</p>



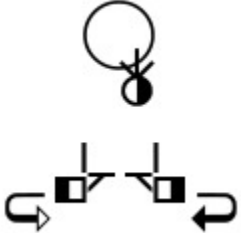

ASL Bible Dictionary

Spoken Word	SignWriting
poison	<p>The signwriting for 'poison' consists of a circle with a dot inside, followed by a hand sign with the index finger pointing up and the thumb pointing right, then a star, and finally a hand sign with the index finger pointing up and the thumb pointing right, with a small circle above the index finger.</p>
Pokereth	<p>The signwriting for 'Pokereth' is a vertical sequence of signs: a hand sign with the index finger pointing up and the thumb pointing right, a diamond shape, a solid black circle, a hand sign with the index finger pointing up and the thumb pointing right, a hand sign with the index finger pointing up and the thumb pointing right, a hand sign with the index finger pointing up and the thumb pointing right, a hand sign with the index finger pointing up and the thumb pointing right, a hand sign with the index finger pointing up and the thumb pointing right, and a hand sign with the index finger pointing up and the thumb pointing right.</p>
pole	<p>The signwriting for 'pole' consists of two vertical parallel lines, with a hand sign below them showing the index finger pointing up and the thumb pointing right.</p>
police	<p>The signwriting for 'police' consists of a hand sign with the index finger pointing up and the thumb pointing right, followed by a horizontal line, and then two stars.</p>
policy	<p>The signwriting for 'policy' consists of a hand sign with the index finger pointing up and the thumb pointing right, followed by a star, and then a hand sign with the index finger pointing up and the thumb pointing right, with a small circle above the index finger.</p>
polish	<p>The signwriting for 'polish' consists of a hand sign with the index finger pointing up and the thumb pointing right, followed by a hand sign with the index finger pointing up and the thumb pointing right, and then a hand sign with the index finger pointing up and the thumb pointing right, with a small circle above the index finger.</p>
polite	<p>The signwriting for 'polite' consists of two stars followed by a hand sign with the index finger pointing up and the thumb pointing right.</p>

ASL Bible Dictionary

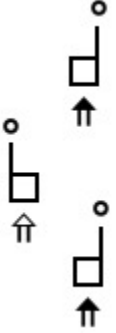
Spoken Word	SignWriting
pomp	
Pontius	
Pontus	
pool	
poor	
pop-up	

ASL Bible Dictionary

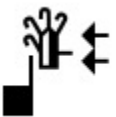
Spoken Word	SignWriting
popcorn	
Pope	
poplar	
poplar	
popular	







ASL Bible Dictionary

Spoken Word	SignWriting
<p>population</p>	<p>The SignWriting for 'population' consists of four distinct signs arranged vertically. The first sign is a square with a diagonal line from the top-left to the bottom-right. The second sign is a square with a diagonal line from the top-right to the bottom-left. The third sign is a square with a vertical line on the left and a horizontal line on the top. The fourth sign is a square with a vertical line on the right and a horizontal line on the top.</p>
<p>Poratha</p>	<p>The SignWriting for 'Poratha' consists of seven distinct signs arranged vertically. The first sign is a diamond with a diagonal line from the top-left to the bottom-right. The second sign is a solid black circle. The third sign is a square with a vertical line on the left and a horizontal line on the top. The fourth sign is a square with a vertical line on the right and a horizontal line on the top. The fifth sign is a square with a vertical line on the left and a horizontal line on the top. The sixth sign is a square with a vertical line on the right and a horizontal line on the top. The seventh sign is a square with a vertical line on the left and a horizontal line on the top.</p>
<p>porch</p>	<p>The SignWriting for 'porch' consists of seven distinct signs arranged vertically. The first sign is a diamond with a diagonal line from the top-left to the bottom-right. The second sign is a solid black circle. The third sign is a square with a vertical line on the left and a horizontal line on the top. The fourth sign is a square with a vertical line on the right and a horizontal line on the top. The fifth sign is a square with a vertical line on the left and a horizontal line on the top. The sixth sign is a square with a vertical line on the right and a horizontal line on the top. The seventh sign is a square with a vertical line on the left and a horizontal line on the top.</p>
<p>Porcius</p>	<p>The SignWriting for 'Porcius' consists of seven distinct signs arranged vertically. The first sign is a diamond with a diagonal line from the top-left to the bottom-right. The second sign is a solid black circle. The third sign is a square with a vertical line on the left and a horizontal line on the top. The fourth sign is a square with a vertical line on the right and a horizontal line on the top. The fifth sign is a square with a vertical line on the left and a horizontal line on the top. The sixth sign is a square with a vertical line on the right and a horizontal line on the top. The seventh sign is a square with a vertical line on the left and a horizontal line on the top.</p>

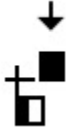
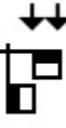
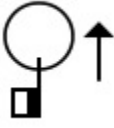

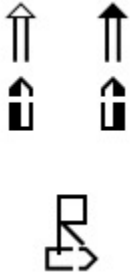
ASL Bible Dictionary

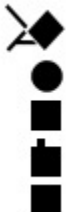
Spoken Word	SignWriting
porphyry	<p>The SignWriting for 'porphyry' consists of the following elements from top to bottom: a diamond with a diagonal line, a circle, a square with a diagonal line, a diamond with a diagonal line, a square with a diagonal line, a square with a diagonal line, a square with a diagonal line, and a square with a diagonal line.</p>
port	<p>The SignWriting for 'port' consists of the following elements from top to bottom: a diamond with a diagonal line, a circle, a square with a diagonal line, and a square with a diagonal line.</p>
Portugal	<p>The SignWriting for 'Portugal' consists of the following elements from top to bottom: a diamond with a diagonal line, a circle, a square with a diagonal line, a square with a diagonal line, a square with a diagonal line, a square with a diagonal line, a square with a diagonal line, a square with a diagonal line, and a square with a diagonal line.</p>
position	<p>The SignWriting for 'position' consists of the following elements from top to bottom: a diamond with a diagonal line, a circle, a square with a diagonal line, a square with a diagonal line, a square with a diagonal line, a square with a diagonal line, a square with a diagonal line, a square with a diagonal line, and a square with a diagonal line.</p>







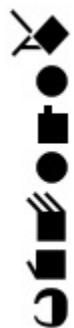

ASL Bible Dictionary

Spoken Word	SignWriting
positive	
positive	
positive	
possessed	
post	
postpone	
posts	
pot	

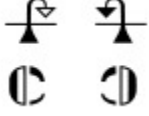





ASL Bible Dictionary

Spoken Word	SignWriting
potato	
Potiphar	
Potipherah	
Potomac	









ASL Bible Dictionary

Spoken Word	SignWriting
pour	
pour	
pour	
pour	
pout	
power	
power	
powers	
practice	



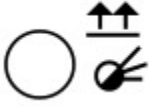

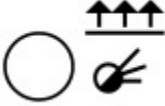
ASL Bible Dictionary

Spoken Word	SignWriting
Praetorium	
praise	
praise	
praise	
praise	
praise	
praise	



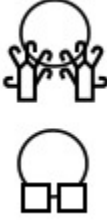

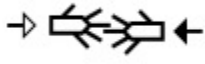
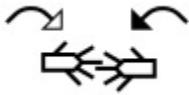

ASL Bible Dictionary

Spoken Word	SignWriting
pray	
pray	
prayer	
prayers	
praying	
preach	
preach	
preaching	
preaching	

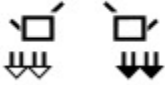
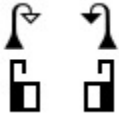
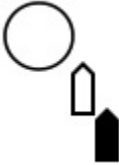
ASL Bible Dictionary

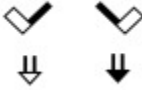
Spoken Word	SignWriting
precious	
precious	
precious	
pregnant	
pregnant	
prepare	
Presence	

ASL Bible Dictionary

Spoken Word	SignWriting
present	
present	
presented	
presenting	
presently	
president	
press	
pressure	
pressures	









ASL Bible Dictionary

Spoken Word	SignWriting
pretty	<p>The sign for 'pretty' is composed of three elements: a circle with a vertical line through its center, a stylized tree with many branches, and a small triangle with a squiggle underneath it.</p>
preview	<p>The sign for 'preview' consists of four parts: a circle with two horizontal lines inside, a square with a vertical line on its right side, a square with a vertical line on its left side and a downward-pointing arrow below it, and two squares with vertical lines on their left sides and upward-pointing arrows above them.</p>
prices	<p>The sign for 'prices' is formed by a square with a vertical line on its left side and an upward-pointing arrow above it, a square with a vertical line on its right side and a downward-pointing arrow below it, and another square with a vertical line on its right side and a downward-pointing arrow below it.</p>
pride	<p>The sign for 'pride' is composed of an upward-pointing arrow above a square with a vertical line on its right side, and a square with a vertical line on its right side and a diagonal line extending from the top-left corner to the bottom-right corner.</p>
priest	<p>The sign for 'priest' is shown as a circle with a vertical line through its center, a square with a vertical line on its right side, and a rightward-pointing arrow below the square.</p>
priests	<p>The sign for 'priests' is similar to 'priest' but includes a double rightward-pointing arrow below the square.</p>
prince	<p>The sign for 'prince' is a square with a vertical line on its right side, a diagonal line from the top-left to the bottom-right, and a rightward-pointing arrow below it, followed by two asterisks.</p>







ASL Bible Dictionary

Spoken Word	SignWriting
prince	
princes	
principal	
principle	
principle	
principles	
Priscilla	

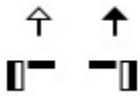
ASL Bible Dictionary

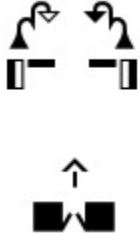
Spoken Word	SignWriting
prison	
prison	
prisoner	
prisoners	
private	
privileges	
problem	
problem	







ASL Bible Dictionary

Spoken Word	SignWriting
proceed	
proceed	
proceed	
process	
procession	
proclaim	
Procorus	





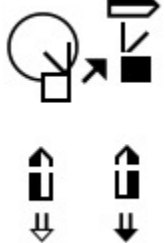

ASL Bible Dictionary

Spoken Word	SignWriting
productive	<p>The SignWriting for 'productive' consists of two parts. The first part shows two diamond shapes, one above the other, with lines extending from their vertices. The second part shows a hand with fingers spread, positioned above a square shape, with a vertical line extending upwards from the top of the square.</p>
profit	<p>The SignWriting for 'profit' consists of two parts. The first part shows a horizontal line above a hand with fingers spread. The second part shows a hand with fingers spread above a circle with a dot in the center, which is above a vertical line with three horizontal bars extending from its base.</p>
program	<p>The SignWriting for 'program' consists of two parts. The first part shows a diamond shape with lines extending from its vertices, positioned above a hand with fingers spread. The second part shows a hand with fingers spread above a vertical rectangle, with a curved arrow pointing from the top of the rectangle back to the hand.</p>
program	<p>The SignWriting for 'program' consists of two parts. The first part shows a diamond shape with lines extending from its vertices, positioned above a hand with fingers spread. The second part shows a hand with fingers spread above a vertical rectangle, with a curved arrow pointing from the top of the rectangle back to the hand.</p>

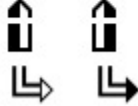





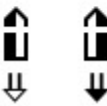

ASL Bible Dictionary

Spoken Word	SignWriting
promote	
proof	
proof	
propaganda	
prophecy	
prophecy	
Prophet	



ASL Bible Dictionary

Spoken Word	SignWriting
Prophets	 
prosper	 
protect	
protect	
protection	
protector	 



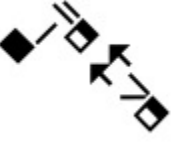

ASL Bible Dictionary

Spoken Word	SignWriting
protracted	 
proud	
proud	
prove	
prove	 
proverb	



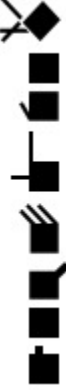

ASL Bible Dictionary

Spoken Word	SignWriting
Proverbs	 <p>The signwriting for 'Proverbs' consists of a vertical sequence of symbols: a diamond with a diagonal line, a square with a diagonal line, a circle, a square with a diagonal line, a square with a diagonal line, a square with a diagonal line, and a square with a diagonal line.</p>
Proverbs	 <p>The signwriting for 'Proverbs' consists of a vertical sequence of symbols: a square with a diagonal line, a square with a diagonal line, a circle, a square with a diagonal line, a square with a diagonal line, a square with a diagonal line, and a square with a diagonal line.</p>
prune	 <p>The signwriting for 'prune' consists of a vertical sequence of symbols: a diamond with a diagonal line, a square with a diagonal line, a square with a diagonal line, a square with a diagonal line, and a square with a diagonal line.</p>
prunes	 <p>The signwriting for 'prunes' consists of a vertical sequence of symbols: a diamond with a diagonal line, a square with a diagonal line, a square with a diagonal line, a square with a diagonal line, and a square with a diagonal line.</p>



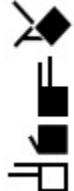

ASL Bible Dictionary

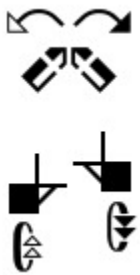
Spoken Word	SignWriting
Psalm	
psalm	
psalmist	
psalms	
Psalms	



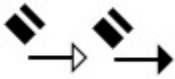
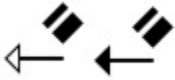

ASL Bible Dictionary

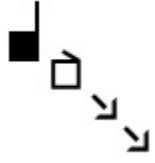
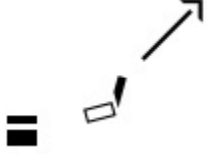
Spoken Word	SignWriting
psych	
psychology	
Ptolemais	
Puah	
public	
public	



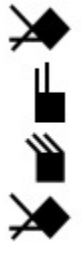

ASL Bible Dictionary

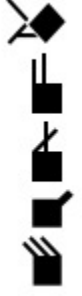
Spoken Word	SignWriting
puff-air	
pull	
pull	
pull	
pull	
pull-back	
pull-net	



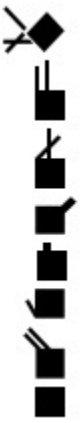

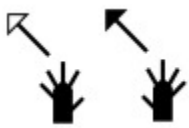
ASL Bible Dictionary

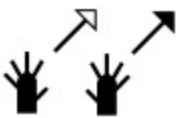
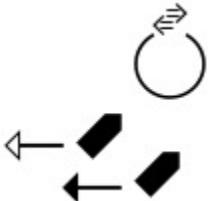
Spoken Word	SignWriting
pull-out	
pump	
punish	
punish	
pure	
pure	
Purim	



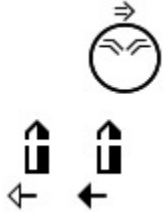
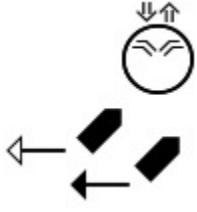
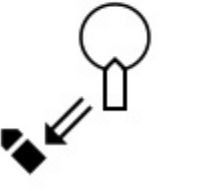

ASL Bible Dictionary

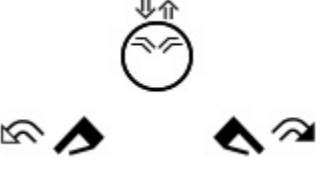
Spoken Word	SignWriting
Puritans	
purple	
push	
push	
push	
push	
push-aside	



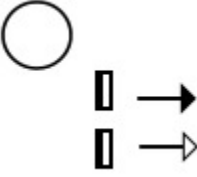

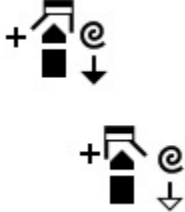
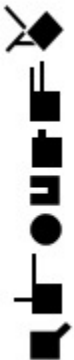
ASL Bible Dictionary

Spoken Word	SignWriting
push-aside	
push-away	
push-away-evil	
push-over	
put	
put	
put	



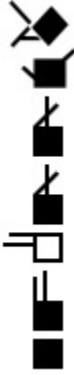

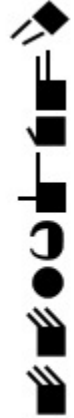

ASL Bible Dictionary

Spoken Word	SignWriting
Put-aside	
put-on	
put-on	
put-on-shoes	
Puteoli	
puzzle	
puzzled	

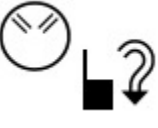
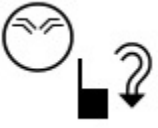
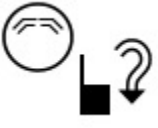

ASL Bible Dictionary

Spoken Word	SignWriting
Pyrrhus	
Q	
q-eup	
Qualcomm	
qualify	
quarterback	

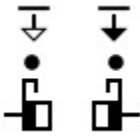
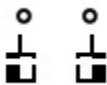
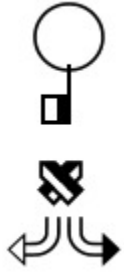

ASL Bible Dictionary

Spoken Word	SignWriting
Quartus	
queen	
question	
question	
question	
question	
question	
questions	

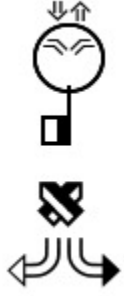

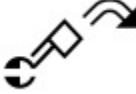

ASL Bible Dictionary

Spoken Word	SignWriting
quick	
quickly	
quiet	
quiet	
quiet	



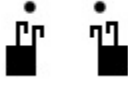
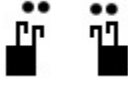
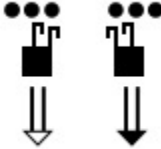

ASL Bible Dictionary

Spoken Word	SignWriting
<p>Quirinius</p>	 <p>The SignWriting for 'Quirinius' is a vertical sequence of 14 symbols. From top to bottom: a diamond with two diagonal lines; a horizontal line; a square with a horizontal line; a square with a vertical line; a square with a diagonal line; a square with a horizontal line; a square with a vertical line; a square with a diagonal line; a square with a horizontal line; a square with a vertical line; a square with a diagonal line; a square with a horizontal line; a square with a vertical line; and a square with a diagonal line.</p>
<p>quit</p>	 <p>The SignWriting for 'quit' consists of a diamond with a horizontal line, a square with a horizontal line, and a square with a vertical line. Below these symbols is a vertical line with an asterisk. To the right of the diamond and square symbols are two curved arrows indicating movement.</p>
<p>quit</p>	 <p>The SignWriting for 'quit' consists of a diamond with a horizontal line, a square with a horizontal line, and a square with a vertical line. To the right of these symbols are two curved arrows indicating movement.</p>



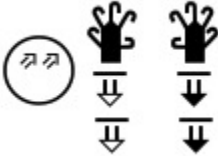
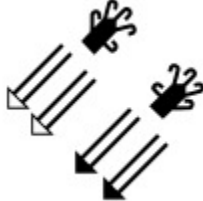

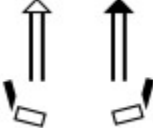
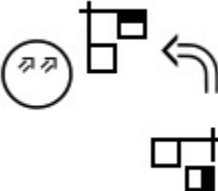
ASL Bible Dictionary

Spoken Word	SignWriting
quiver	
quote	
quote	
quotes	
R	
Raamah	
Raamah	





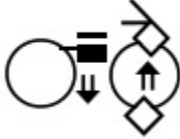

ASL Bible Dictionary

Spoken Word	SignWriting
rain	
rain	
rainbow	
raise hands	
raise-cross	
raising-from-dead	



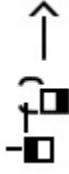



ASL Bible Dictionary

Spoken Word	SignWriting
raisins	
Ram	
ram	
ram	
Ramah	
Rameses	

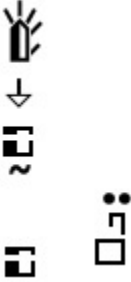



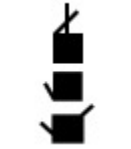

ASL Bible Dictionary

Spoken Word	SignWriting
ramp	
ran	
ran	
ransom	
ransom	
ransom	

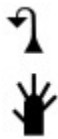

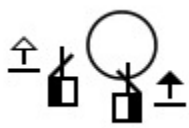

ASL Bible Dictionary

Spoken Word	SignWriting
ransom	 <p>The SignWriting for 'ransom' consists of a vertical sequence of symbols: a hand with fingers spread, a downward arrow, a square with a vertical line, a tilde symbol, a square with a vertical line, and a square with a vertical line and two dots to its right.</p>
rare	 <p>The SignWriting for 'rare' consists of a vertical sequence of symbols: a square with a vertical line, a diamond, and a circular arrow.</p>
ration	 <p>The SignWriting for 'ration' consists of two vertical sequences of symbols. The first sequence has a square with a vertical line and an upward arrow, followed by a square with a vertical line and an upward arrow. The second sequence has a square with a vertical line and a curved arrow, followed by a square with a vertical line and a curved arrow.</p>
ravens	 <p>The SignWriting for 'ravens' consists of a vertical sequence of symbols: a hand with fingers spread, a square with a vertical line, a square with a vertical line, a square with a vertical line, a square with a vertical line, a square with a vertical line, a square with a vertical line, a square with a vertical line, a square with a vertical line, and a square with a vertical line.</p>
Ray	 <p>The SignWriting for 'Ray' consists of a vertical sequence of symbols: a hand with fingers spread, a square with a vertical line, a square with a vertical line, and a square with a vertical line.</p>
ray	 <p>The SignWriting for 'ray' consists of a vertical sequence of symbols: a hand with fingers spread, a square with a vertical line, a square with a vertical line, and a square with a vertical line.</p>



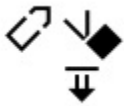

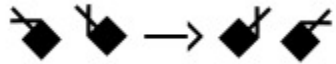
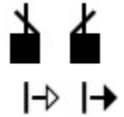

ASL Bible Dictionary

Spoken Word	SignWriting
RDB	
reach	
reach	
reach	
reach-touch	
reached	
reaction	
read	
read	

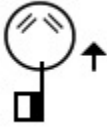
ASL Bible Dictionary

Spoken Word	SignWriting
read	
reader	
ready	
ready	
ready	
Reagan	
Reagan	



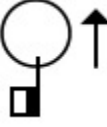
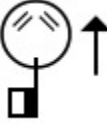



ASL Bible Dictionary

Spoken Word	SignWriting
Reaiah	
real	
realize	
realize	
realize	
realize	
realize	
really	
really-eup	

ASL Bible Dictionary

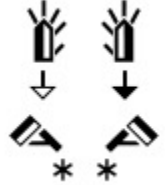
Spoken Word	SignWriting
rebels	<p>The signwriting for 'rebels' consists of four distinct symbols arranged in a 2x2 grid. The top-left symbol is a white square with a black outline and a black arrow pointing to the right. The top-right symbol is a solid black square. The bottom-left symbol is a solid black square with a black arrow pointing to the right. The bottom-right symbol is a white square with a black outline and a black arrow pointing to the right.</p>
rebuke	<p>The signwriting for 'rebuke' consists of two symbols. The top symbol is a white square with a black outline and a black arrow pointing to the right. The bottom symbol is a solid black square with a black arrow pointing to the right.</p>
rebuke	<p>The signwriting for 'rebuke' consists of three symbols. The top symbol is a white square with a black outline and a black arrow pointing to the right. The middle symbol is a solid black square with a black arrow pointing to the right. The bottom symbol is a solid black square with a black arrow pointing to the right.</p>
rebuke	<p>The signwriting for 'rebuke' consists of two symbols. The top symbol is a white square with a black outline and a black arrow pointing to the right. The bottom symbol is a solid black square with a black arrow pointing to the right.</p>
rebuke	<p>The signwriting for 'rebuke' consists of three symbols. The top symbol is a white square with a black outline and a black arrow pointing to the right. The middle symbol is a solid black square with a black arrow pointing to the right. The bottom symbol is a solid black square with a black arrow pointing to the right.</p>
Recab	<p>The signwriting for 'Recab' consists of a single vertical sequence of symbols. From top to bottom: a white square with a black outline and a black arrow pointing to the right; a solid black square with a black arrow pointing to the right; a white square with a black outline and a black arrow pointing to the right; a solid black square with a black arrow pointing to the right; a white square with a black outline and a black arrow pointing to the right; a solid black square with a black arrow pointing to the right; a white square with a black outline and a black arrow pointing to the right; a solid black square with a black arrow pointing to the right.</p>
receive	<p>The signwriting for 'receive' consists of four symbols. The top symbol is a white square with a black outline and a black arrow pointing to the right. The second symbol is a solid black square with a black arrow pointing to the right. The third symbol is a white square with a black outline and a black arrow pointing to the right. The bottom symbol is a solid black square with a black arrow pointing to the right.</p>





ASL Bible Dictionary

Spoken Word	SignWriting
receive	
receive	
receive	
receive	
recent	
recently	
RECEO	

ASL Bible Dictionary

Spoken Word	SignWriting
record	<p>The signwriting for 'record' consists of two parts. The first part is a circle containing two wavy lines, representing the letter 'R'. This is followed by a vertical bar with a small triangle on top, representing the letter 'D'. The second part is a circle containing two wavy lines, representing the letter 'R', followed by two vertical bars with small triangles on top, representing the letter 'D', and a small arrow pointing to the left.</p>
rectangular box	<p>The signwriting for 'rectangular box' consists of three parts. The first part is a vertical bar with a small triangle on top, representing the letter 'D', followed by a small arrow pointing to the left. The second part is a vertical bar with a small triangle on top, representing the letter 'D', followed by a small arrow pointing to the right. The third part is a vertical bar with a small triangle on top, representing the letter 'D', followed by a small arrow pointing to the right.</p>
Red	<p>The signwriting for 'Red' consists of a vertical bar with a small triangle on top, representing the letter 'D', followed by a small arrow pointing to the right.</p>



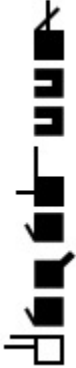



ASL Bible Dictionary

Spoken Word	SignWriting
red	
red	
redeem	
redeem	
reed	
Reelaiah	

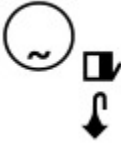
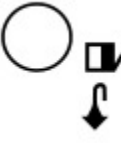
ASL Bible Dictionary

Spoken Word	SignWriting
ref	<p>The signwriting for 'ref' consists of a vertical stack of three elements: a hand with fingers pointing up, a square with a horizontal line through its center, and a hand with fingers pointing up.</p>
refer	<p>The signwriting for 'refer' consists of a diamond shape with an 'X' inside, and an upward-pointing arrow to its right.</p>
reflect	<p>The signwriting for 'reflect' consists of two parts. The top part is a circle with a square to its right, representing a magnifying glass. The bottom part is a house-like shape with a vertical line above it, and a diamond with an upward-pointing arrow to its right.</p>
reflect	<p>The signwriting for 'reflect' consists of two parts. The top part is a circle with a square to its right, representing a magnifying glass. The bottom part is a house-like shape with a vertical line above it, and a diamond with an upward-pointing arrow to its right.</p>
reflection	<p>The signwriting for 'reflection' consists of two rows. The top row has two identical symbols, each a diamond with a vertical line through its center. The bottom row has two identical symbols, each a house-like shape with a vertical line above it.</p>
refrained	<p>The signwriting for 'refrained' is a circle with a horizontal line through its center.</p>
refuge	<p>The signwriting for 'refuge' consists of two parts. The top part is a house-like shape with a vertical line above it. The bottom part is a diamond with a diagonal line through its center.</p>





ASL Bible Dictionary

Spoken Word	SignWriting
refuse	
refuse	
refusing	
regarding	
regarding	
regarding	
regiment	





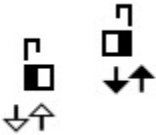
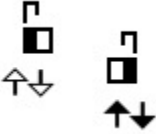

ASL Bible Dictionary

Spoken Word	SignWriting
regiment	
regular	
regular	
Rehoboam	
Rehoboth	





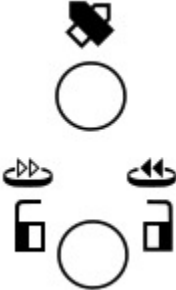
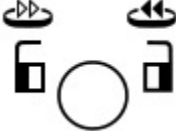



ASL Bible Dictionary

Spoken Word	SignWriting
Rehum	
Rehum	
Reich	
reign	
reign	
reign	







ASL Bible Dictionary

Spoken Word	SignWriting
reject	
reject	
reject	
reject	
rejoice	
rejoice	
rejoice	
related	





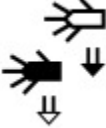
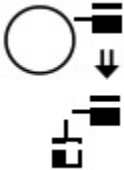

ASL Bible Dictionary

Spoken Word	SignWriting
related	
related	
related	
related	
relation	
relations	
relative	
release	
release	

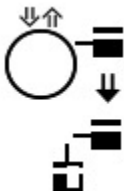

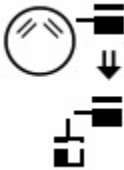
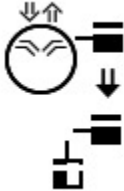



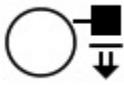

ASL Bible Dictionary

Spoken Word	SignWriting
release	
religion	
religions	
remain	
remain	
remain	
remain	
remainder	
remember	

ASL Bible Dictionary

Spoken Word	SignWriting
remember	
remember	 
remember	
remember	
remind	
remind	
remind	
reminder	
reminder	

ASL Bible Dictionary

Spoken Word	SignWriting
reminder	 
remove	
remove	
remove	
remove	
remove-eye	
remove-eyes	
remove-shoe	





ASL Bible Dictionary

Spoken Word	SignWriting
renal	<p>The sign for 'renal' is a vertical sequence of five distinct handshapes: a hand with fingers spread, a hand with fingers curled, a hand with fingers spread, a hand with fingers curled, and a hand with fingers spread.</p>
rent	<p>The sign for 'rent' consists of a handshape with fingers spread, followed by a handshape with fingers curled, and a handshape with fingers spread.</p>
rents	<p>The sign for 'rents' is similar to 'rent' but includes a handshape with fingers spread at the end.</p>
rep	<p>The sign for 'rep' starts with a handshape with fingers spread, followed by a handshape with fingers curled, and a handshape with fingers spread.</p>
repay	<p>The sign for 'repay' is a vertical sequence of three handshapes: a hand with fingers spread, a hand with fingers curled, and a hand with fingers spread.</p>
repeatedly	<p>The sign for 'repeatedly' is a vertical sequence of three handshapes: a hand with fingers spread, a hand with fingers curled, and a hand with fingers spread.</p>
repent	<p>The sign for 'repent' is a vertical sequence of three handshapes: a hand with fingers spread, a hand with fingers curled, and a hand with fingers spread.</p>



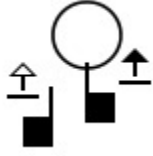
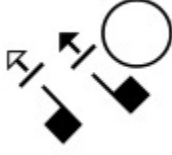
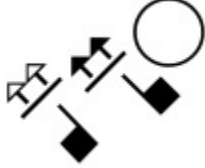
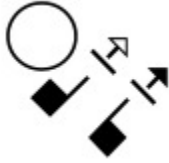
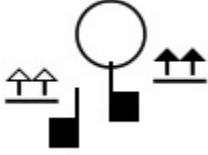

ASL Bible Dictionary

Spoken Word	SignWriting
repent	<p>The SignWriting for 'repent' consists of three vertical signs. The top sign is a diamond shape with a diagonal line from the top-left to the bottom-right. The middle sign is a vertical line with a horizontal line crossing it, and a small vertical line extending from the top of the horizontal line. The bottom sign is a diamond shape with a diagonal line from the top-right to the bottom-left.</p>
Rephaiah	<p>The SignWriting for 'Rephaiah' consists of seven vertical signs. From top to bottom: a vertical line with a horizontal line crossing it; a diamond shape with a diagonal line from the top-left to the bottom-right; a square shape with a horizontal line crossing it; a vertical line with a horizontal line crossing it; a vertical line with a horizontal line crossing it; a vertical line with a horizontal line crossing it; and a square shape with a horizontal line crossing it.</p>
Rephaims	<p>The SignWriting for 'Rephaims' consists of seven vertical signs. From top to bottom: a vertical line with a horizontal line crossing it; a diamond shape with a diagonal line from the top-left to the bottom-right; a square shape with a horizontal line crossing it; a vertical line with a horizontal line crossing it; a vertical line with a horizontal line crossing it; a vertical line with a horizontal line crossing it; and a vertical line with a horizontal line crossing it.</p>
Rephan	<p>The SignWriting for 'Rephan' consists of six vertical signs. From top to bottom: a vertical line with a horizontal line crossing it; a diamond shape with a diagonal line from the top-left to the bottom-right; a square shape with a horizontal line crossing it; a vertical line with a horizontal line crossing it; a vertical line with a horizontal line crossing it; and a vertical line with a horizontal line crossing it.</p>
replace	<p>The SignWriting for 'replace' consists of four vertical signs. From top to bottom: a vertical line with a horizontal line crossing it; a vertical line with a horizontal line crossing it; a vertical line with a horizontal line crossing it; and a vertical line with a horizontal line crossing it.</p>



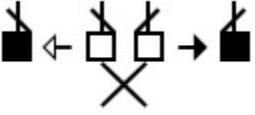

ASL Bible Dictionary

Spoken Word	SignWriting
report	
report	
report	
report	
reports	
represent	
represent	
represent	



ASL Bible Dictionary

Spoken Word	SignWriting
requests	
require	
requirements	
rescue	
researcher	
researchers	





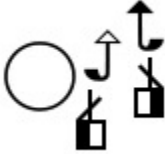
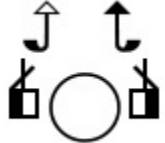
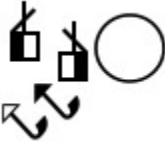
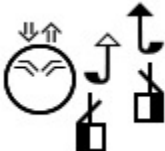
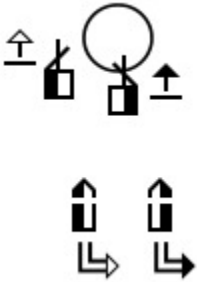

ASL Bible Dictionary

Spoken Word	SignWriting
Resen	
Residence	
resist	
resist	
resolutely	

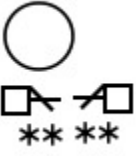
ASL Bible Dictionary

Spoken Word	SignWriting
resources	
respect	
respect	
respect	
respect	
responders	
responsibilities	

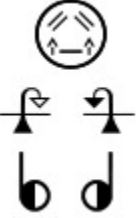
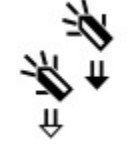
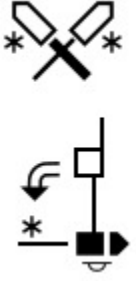



ASL Bible Dictionary

Spoken Word	SignWriting
responsibility	
responsible	
responsible	
rest	
rest	
rest	
rest-day	
restless	

ASL Bible Dictionary

Spoken Word	SignWriting
restore	<p>The signwriting for 'restore' consists of three vertical elements: a square, a cluster of three squares, and a hand with an arrow pointing up and to the right.</p>
restrain	<p>The signwriting for 'restrain' consists of three vertical elements: a circle with a downward arrow, a hand with a downward arrow, and a square.</p>
restrain	<p>The signwriting for 'restrain' consists of three vertical elements: a circle with a horizontal line through it, an upward arrow, and a hand with fingers spread.</p>
restrict	<p>The signwriting for 'restrict' consists of two vertical elements: a hand with an upward arrow, and a hand with an upward arrow and a square.</p>
restroom	<p>The signwriting for 'restroom' consists of two vertical elements: a hand with a downward arrow, and a hand with a downward arrow and a square.</p>
result	<p>The signwriting for 'result' consists of a top circle with two horizontal lines, and a bottom row of four elements: a hand with an upward arrow, a hand with a downward arrow, a hand with a downward arrow and a square, and a hand with an upward arrow.</p>
result	<p>The signwriting for 'result' consists of a top circle with two horizontal lines, and a bottom row of four elements: a hand with a downward arrow, a hand with a downward arrow and a square, a hand with a downward arrow and a square, and a hand with a downward arrow.</p>





ASL Bible Dictionary

Spoken Word	SignWriting
resurrect	
resurrection	
retinal	
retinopathy	
retreat	

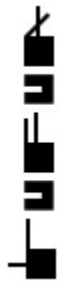
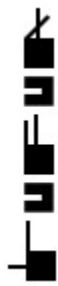

ASL Bible Dictionary

Spoken Word	SignWriting
retro	<p>The SignWriting for 'retro' consists of a vertical sequence of symbols: a downward-pointing arrow, a square, a horizontal line, another square, a second downward-pointing arrow, and a solid black circle at the bottom.</p>
return	<p>The SignWriting for 'return' features a circle containing two right-pointing arrows, followed by a square with an upward-pointing arrow, and a final square with a downward-pointing arrow.</p>
return	<p>The SignWriting for 'return' includes a circle with two left-pointing arrows, a square with a left-pointing arrow, and a final square with a downward-pointing arrow.</p>
returned	<p>The SignWriting for 'returned' is identical to the 'return' entry, showing a circle with two right-pointing arrows, a square with an upward-pointing arrow, and a square with a downward-pointing arrow.</p>
returned	<p>The SignWriting for 'returned' consists of a circle, a square with a downward-pointing arrow, and a final square with a downward-pointing arrow.</p>
Reu	<p>The SignWriting for 'Reu' is a vertical sequence of symbols: a downward-pointing arrow, a square, a horizontal line, another square, and a final downward-pointing arrow.</p>
Reuben	<p>The SignWriting for 'Reuben' is a vertical sequence of symbols: a downward-pointing arrow, a square, a horizontal line, another square, a downward-pointing arrow, a square, a horizontal line, another square, a downward-pointing arrow, a square, a horizontal line, another square, a downward-pointing arrow, and a final square.</p>





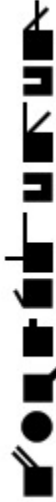

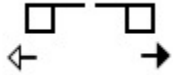
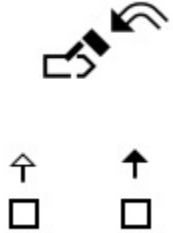
ASL Bible Dictionary

Spoken Word	SignWriting
Reuel	
Reuel	
Reumah	
reveal	
reveal	

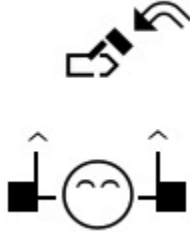



ASL Bible Dictionary

Spoken Word	SignWriting
Revelation	
Revelation 22:19	
revenge	
Reverend	
reverse	
revival	

ASL Bible Dictionary

Spoken Word	SignWriting
revive	
revive	
revolt	
reward	
rewarded	
Rezin	

ASL Bible Dictionary

Spoken Word	SignWriting
Rhegium	
Rhesa	
Rhoda	
Rhodes	
Riane	









ASL Bible Dictionary

Spoken Word	SignWriting
Richard	<p>The SignWriting for 'Richard' consists of a vertical sequence of symbols: a solid black circle at the bottom, followed by a horizontal line, a solid black square, a solid black triangle pointing right, a solid black square, a solid black circle, a solid black square, a solid black triangle pointing left, a solid black square, and a solid black triangle pointing right at the top.</p>
riches	<p>The SignWriting for 'riches' consists of a vertical sequence of symbols: a solid black square, a solid black triangle pointing right, a solid black square, a solid black triangle pointing left, a solid black square, and a solid black circle at the top.</p>
riddle	<p>The top part of the SignWriting for 'riddle' consists of a solid black circle, a solid black triangle pointing right, and a solid black square with a plus sign inside.</p> <p>The bottom part of the SignWriting for 'riddle' consists of a solid black square and a question mark.</p>
riddle	<p>The SignWriting for 'riddle' consists of a vertical sequence of symbols: a solid black square, a solid black triangle pointing right, a solid black square, a solid black circle, a solid black square, and a solid black triangle pointing left at the top.</p>
riddle	<p>The SignWriting for 'riddle' consists of a vertical sequence of symbols: a solid black square, a solid black triangle pointing right, a solid black square, a solid black circle, a solid black square, and a solid black triangle pointing left at the top.</p>

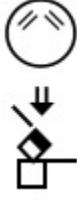

ASL Bible Dictionary

Spoken Word	SignWriting
riddles	<p>The signwriting for 'riddles' consists of a vertical sequence of symbols: a hand with fingers spread, a hand with fingers curled, a hand with fingers spread, a hand with fingers curled, a hand with fingers spread, a hand with fingers curled, a hand with fingers spread, a hand with fingers curled, a hand with fingers spread, and a hand with fingers curled.</p>
ride	<p>The signwriting for 'ride' shows a hand with fingers curled, followed by a hand with fingers spread.</p>
ride	<p>The signwriting for 'ride' shows a hand with fingers spread, followed by a hand with fingers curled.</p>
ride	<p>The signwriting for 'ride' shows a hand with fingers curled, followed by a hand with fingers spread, and a hand with fingers curled.</p>
ride	<p>The signwriting for 'ride' shows a hand with fingers spread, followed by a hand with fingers curled, and a hand with fingers spread.</p>
ride	<p>The signwriting for 'ride' shows a hand with fingers spread, followed by a hand with fingers curled, and a hand with fingers spread.</p>
ride	<p>The signwriting for 'ride' shows a hand with fingers spread, followed by a hand with fingers curled, and a hand with fingers spread.</p>





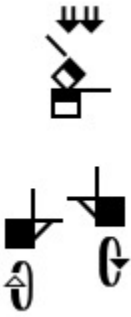

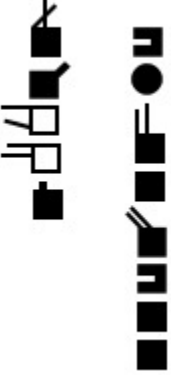
ASL Bible Dictionary

Spoken Word	SignWriting
ride	
ride	
rider	
right	
right	
right	
right	
right	
righteous	

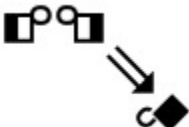

ASL Bible Dictionary

Spoken Word	SignWriting
righteous	
righteous	
righteous	
righteousness	



ASL Bible Dictionary

Spoken Word	SignWriting
ringstraked	
riot	
riot	
rip	
ripe	
Riphath	
rise	

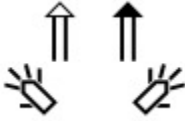
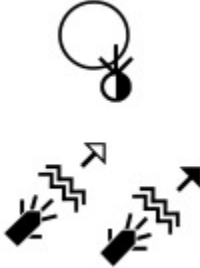
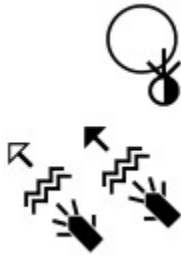
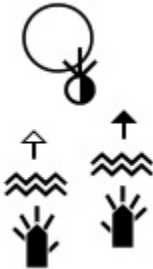
ASL Bible Dictionary

Spoken Word	SignWriting
rise	
rise	
rise	
river	
river	
river	

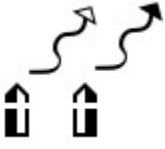
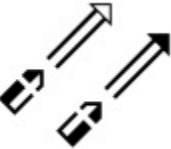
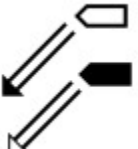
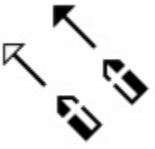

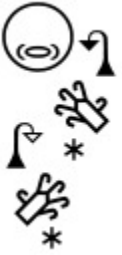
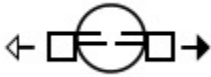

ASL Bible Dictionary

Spoken Word	SignWriting
RN	
road	
road	
road	
road	
road	
roar	
robber	



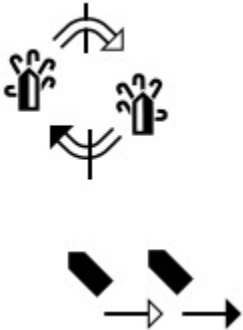

ASL Bible Dictionary

Spoken Word	SignWriting
robe	<p>The signwriting for 'robe' consists of a vertical sequence of symbols: a hand with fingers spread, a solid black circle, a solid black square, and a solid black rectangle.</p>
robe-on	<p>The signwriting for 'robe-on' features a horizontal line with two diamond shapes below it. Curved arrows on either side indicate movement or direction.</p>
rock	<p>The signwriting for 'rock' includes a hash symbol (#) above a hand symbol with fingers spread.</p>
rock	<p>The signwriting for 'rock' shows three circular symbols, each with a curved arrow above it, indicating a specific hand movement.</p>
rock	<p>The signwriting for 'rock' is a vertical sequence: a hand with fingers spread, a solid black circle, a solid black square, and a hand with fingers spread.</p>
rocky	<p>The signwriting for 'rocky' features two hash symbols (##) above a hand symbol with fingers spread.</p>
Roehl	<p>The signwriting for 'Roehl' is a vertical sequence: a hand with fingers spread, a solid black circle, a solid black square, a hand with fingers spread, and a hand with fingers spread.</p>
role	<p>The signwriting for 'role' consists of a hand with fingers spread, a solid black circle, and a hand with fingers spread.</p>



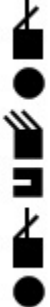



ASL Bible Dictionary

Spoken Word	SignWriting
roll-stone	
roll-stone	
roll-stone	
roll-stone	
roll-up	
Roman	

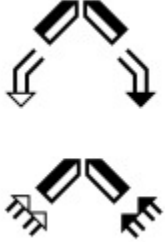

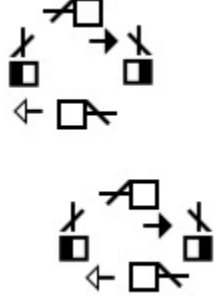



ASL Bible Dictionary

Spoken Word	SignWriting
Romans	
Romero	
Ron	
Ron	
Ronald	
roof	

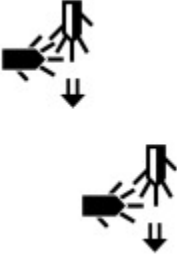

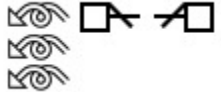

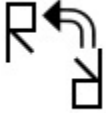

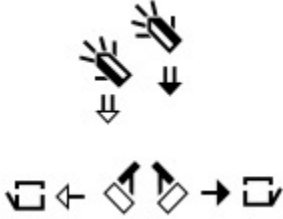

ASL Bible Dictionary

Spoken Word	SignWriting
roof	
room	
rooms	
rooster	
root	
roots	





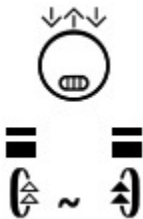

ASL Bible Dictionary

Spoken Word	SignWriting
roots	
roots	
rope	
ropes	
rose	
rose	
Rosh	

ASL Bible Dictionary

Spoken Word	SignWriting
rot	
rot	
rot	
rough	
rough	
rough	
round	
row	
rowing	

ASL Bible Dictionary

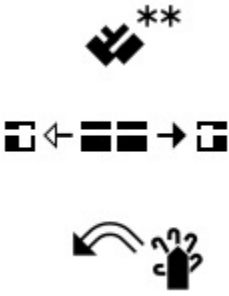
Spoken Word	SignWriting
royal	
royal	
royal	
rub	
rub-eyes	
rub-eyes	
rubble	
rubble	

ASL Bible Dictionary

Spoken Word	SignWriting
ruby	<p>The sign for 'ruby' is written vertically. It starts with a handshape resembling a 'Y' (index and middle fingers extended, thumb tucked). This is followed by a series of horizontal lines and a small 'u' shape, representing the 'BY' part of the word. The final part is a solid black square.</p>
rudder	<p>The sign for 'rudder' is written in three parts. The first part shows a handshape with index and middle fingers extended, moving up and down. The second part shows a handshape with index and middle fingers extended, moving left and right. The third part shows two vertical bars with arrows pointing outwards, representing the rudder's function.</p>
rudders	<p>The sign for 'rudders' is written vertically. It starts with a handshape resembling a 'Y' (index and middle fingers extended, thumb tucked). This is followed by a series of horizontal lines and a small 'u' shape, representing the 'BY' part of the word. The final part is a solid black square.</p>
rude	<p>The sign for 'rude' is written in two parts. The first part shows a handshape with index and middle fingers extended, moving up and down. The second part shows a handshape with index and middle fingers extended, moving left and right.</p>
rude	<p>The sign for 'rude' is written in two parts. The first part shows a handshape with index and middle fingers extended, moving up and down. The second part shows a handshape with index and middle fingers extended, moving left and right.</p>

ASL Bible Dictionary

Spoken Word	SignWriting
ruffles	<p>The signwriting for 'ruffles' consists of a vertical sequence of seven symbols: a hand with fingers spread, a hand with fingers spread, a hand with fingers spread, a hand with fingers spread, a hand with fingers spread, a hand with fingers spread, and a hand with fingers spread.</p>
Rufus	<p>The signwriting for 'Rufus' consists of a vertical sequence of five symbols: a hand with fingers spread, a hand with fingers spread, a hand with fingers spread, a hand with fingers spread, and a hand with fingers spread.</p>
ruhamah	<p>The signwriting for 'ruhamah' consists of a vertical sequence of seven symbols: a hand with fingers spread, a hand with fingers spread, a hand with fingers spread, a hand with fingers spread, a hand with fingers spread, a hand with fingers spread, and a hand with fingers spread.</p>
ruin	<p>The signwriting for 'ruin' consists of a vertical sequence of four symbols: a hand with fingers spread, a hand with fingers spread, a hand with fingers spread, and a hand with fingers spread.</p>
rule	<p>The signwriting for 'rule' consists of a vertical sequence of three symbols: a hand with fingers spread, a hand with fingers spread, and a hand with fingers spread.</p>







ASL Bible Dictionary

Spoken Word	SignWriting
rule	<p>The signwriting for 'rule' consists of two main components. The first is a square with a small square inside, with a downward arrow on the left and an upward arrow on the right. The second is another square with a small square inside, with a downward arrow on the left and an upward arrow on the right, positioned below the first component.</p>
ruler	<p>The signwriting for 'ruler' consists of two main components. The first is a square with a small square inside, with a downward arrow on the left and an upward arrow on the right. The second is another square with a small square inside, with a downward arrow on the left and an upward arrow on the right, positioned below the first component.</p>
ruler	<p>The signwriting for 'ruler' consists of two main components. The first is a square with a small square inside, with a downward arrow on the left and an upward arrow on the right. The second is another square with a small square inside, with a downward arrow on the left and an upward arrow on the right, positioned below the first component.</p>
ruler	<p>The signwriting for 'ruler' consists of two main components. The first is a square with a small square inside, with a downward arrow on the left and an upward arrow on the right. The second is another square with a small square inside, with a downward arrow on the left and an upward arrow on the right, positioned below the first component.</p>
ruler	<p>The signwriting for 'ruler' consists of two main components. The first is a square with a small square inside, with a downward arrow on the left and an upward arrow on the right. The second is another square with a small square inside, with a downward arrow on the left and an upward arrow on the right, positioned below the first component.</p>

ASL Bible Dictionary

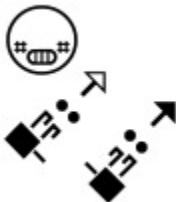
Spoken Word	SignWriting
ruler	<p>The SignWriting for 'ruler' consists of two parts. The first part shows two 'R' symbols, each with a small square on its top-left corner, positioned diagonally. Below them are two 'U' symbols, each with a small square on its top-left corner, positioned vertically. The second part shows two 'R' symbols, each with a small square on its top-left corner, positioned diagonally. Below them are two 'U' symbols, each with a small square on its top-left corner, positioned vertically. The 'U' symbols have arrows pointing up and down, indicating movement.</p>
rulers	<p>The SignWriting for 'rulers' consists of two parts. The first part shows two 'R' symbols, each with a small square on its top-left corner, positioned diagonally. Below them are two 'U' symbols, each with a small square on its top-left corner, positioned vertically. The 'U' symbols have arrows pointing up and down, indicating movement. The second part shows two 'R' symbols, each with a small square on its top-left corner, positioned diagonally. Below them are two 'U' symbols, each with a small square on its top-left corner, positioned vertically. The 'U' symbols have arrows pointing up and down, indicating movement.</p>







ASL Bible Dictionary

Spoken Word	SignWriting
rumor	
run	
run	
run	
run	
run	
run	





ASL Bible Dictionary

Spoken Word	SignWriting
runner	<p>The signwriting for 'runner' consists of three parts: a top part with a diagonal line and an arrow pointing up and to the left, and two bottom parts, each consisting of a vertical line with an arrow pointing up and another pointing down.</p>
running-out	<p>The signwriting for 'running-out' consists of a top part with a diagonal line and an arrow pointing down and to the right, followed by a middle part with a vertical line and an arrow pointing down, and a bottom part with a diagonal line and an arrow pointing up and to the right.</p>
Russell	<p>The signwriting for 'Russell' is a vertical sequence of seven distinct handshapes, starting with a handshape that has the index finger pointing up and the thumb pointing left, followed by several other handshapes.</p>
Russia	<p>The signwriting for 'Russia' shows two handshapes on the left and right, each with an arrow pointing towards the center. In the center, there are two horizontal lines, one above and one below, representing a rectangular shape.</p>
Russia	<p>The signwriting for 'Russia' consists of a circle on the left, a square in the middle, and an arrow pointing to the right.</p>
rust	<p>The signwriting for 'rust' is a vertical sequence of seven distinct handshapes, starting with a handshape that has the index finger pointing up and the thumb pointing left, followed by several other handshapes.</p>



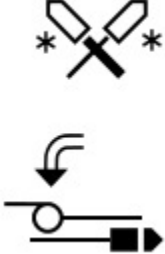



ASL Bible Dictionary

Spoken Word	SignWriting
Ruth	
Ruth	
rx	
S	
S	
S	
sabachthani	

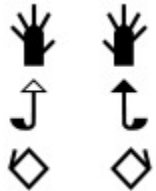
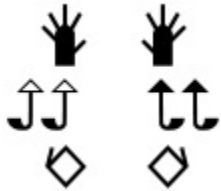

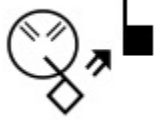



ASL Bible Dictionary

Spoken Word	SignWriting
Sabbath	
Sabbath	
Sabtah	
Sabtecha	
sack	







ASL Bible Dictionary

Spoken Word	SignWriting
sacred	
sacrifice	
sacrifices	
sacrilege	
sacrilege	
sad	
sad	
sad	

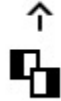



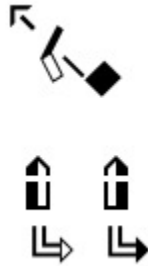

ASL Bible Dictionary

Spoken Word	SignWriting
Sadducee	
Sadducee	
Sadducees	
Sadducees	
sadness	
safari	



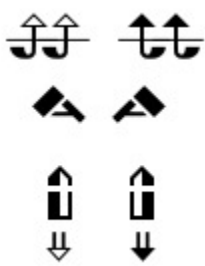

ASL Bible Dictionary

Spoken Word	SignWriting
safe	
sail	
sail	
sailors	
sailors	
sake	
Salah	





ASL Bible Dictionary

Spoken Word	SignWriting
Salamis	
Salem	
salesperson	
Salim	
Salk	
Salk	



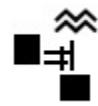

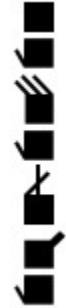
ASL Bible Dictionary

Spoken Word	SignWriting
Sallai	
Sallu	
Salmon	
Salmone	



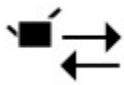
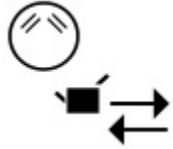
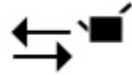
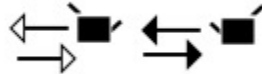

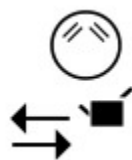
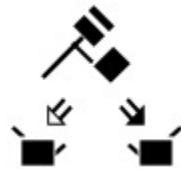
ASL Bible Dictionary

Spoken Word	SignWriting
Salome	
salt	
salute	
Samaria	
Samaritan	
samba	







ASL Bible Dictionary

Spoken Word	SignWriting
same	
same	
same	
same	
same	
same	
same	
same time	
Samlah	

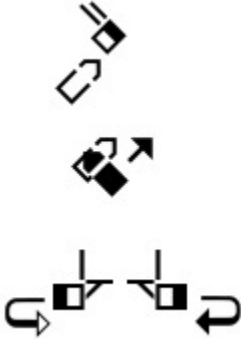

ASL Bible Dictionary

Spoken Word	SignWriting
Samlah	
Samlah	
Samos	
Samothrace	



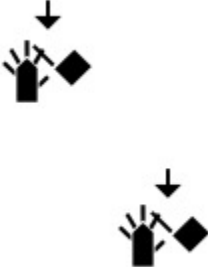
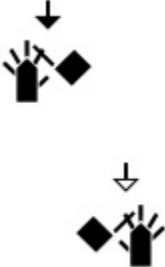

ASL Bible Dictionary

Spoken Word	SignWriting
sanctuary	
sand	
sand	
sand	
sandal	
sandal-remove	
sandal-remove	





ASL Bible Dictionary

Spoken Word	SignWriting
sandals	
sandals	
sandbar	
Sanhedrin	



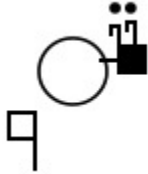

ASL Bible Dictionary

Spoken Word	SignWriting
Sapphira	
Sapphira	
sapphire	
Sarah	

ASL Bible Dictionary

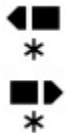
Spoken Word	SignWriting
Sarai	
Sardis	
Satan	
Satan	

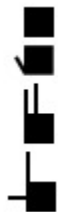

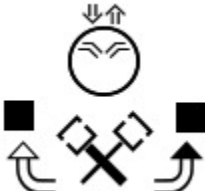

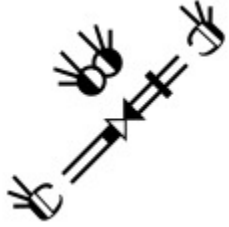
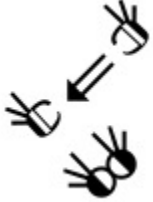
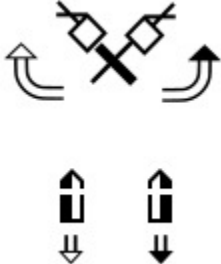
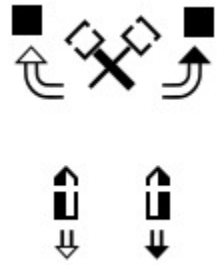
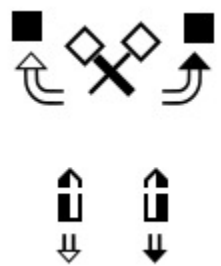
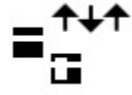

ASL Bible Dictionary

Spoken Word	SignWriting
satisfied	
satisfy	
Saturday	
Saudi Arabia	
Saul	
save	
save	
save	





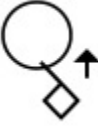

ASL Bible Dictionary

Spoken Word	SignWriting
saved	
saved	
Savior	
Savior	
Savior	
saw	

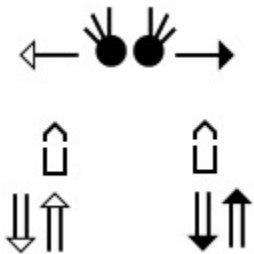

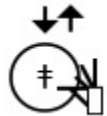

ASL Bible Dictionary

Spoken Word	SignWriting
saw	
saw	
saw	
saw	
say	
say	
say	
say	



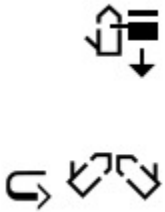

ASL Bible Dictionary

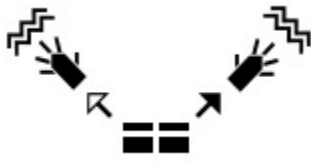
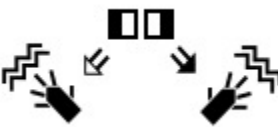
Spoken Word	SignWriting
scales	
scales	
scant	
scar	
scar	
scarce	

ASL Bible Dictionary

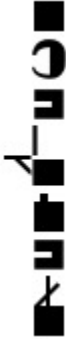
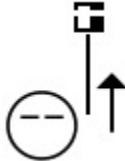
Spoken Word	SignWriting
scarlet	
scarlet	
scars	
scars-show	
scatter	
scatter	
scatter	



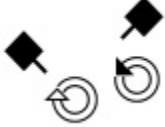
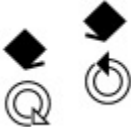



ASL Bible Dictionary

Spoken Word	SignWriting
scatter	
scepter	
sceptre	
scholar	
school	
school	
science	
science	





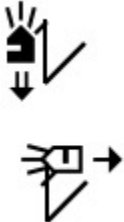

ASL Bible Dictionary

Spoken Word	SignWriting
<p>scientists</p>	<p>The signwriting for 'scientists' consists of two rows of two signs each. The top row signs are diamond shapes with a circular arrow inside, one solid black and one hollow. The bottom row signs are vertical rectangles with a right-pointing arrow at the bottom, one solid black and one hollow.</p>
<p>scoffers</p>	<p>The signwriting for 'scoffers' consists of two rows of two signs each. The top row signs are a sad face with a downward arrow and a square with an upward arrow, one solid black and one hollow. The bottom row signs are vertical rectangles with a right-pointing arrow at the bottom, one solid black and one hollow.</p>
<p>scold</p>	<p>The signwriting for 'scold' consists of a single large sign. It features a hand with a lightning bolt above it, a jagged zigzag line, and a square with a right-pointing arrow.</p>
<p>scoop</p>	<p>The signwriting for 'scoop' consists of two rows of two signs each. The top row signs are a hand with a curved arrow and a hand with a curved arrow, one solid black and one hollow. The bottom row signs are a hand with a curved arrow and a hand with a curved arrow, one solid black and one hollow.</p>
<p>scorch</p>	<p>The signwriting for 'scorch' consists of two rows of two signs each. The top row signs are a hand with a wavy line above it and a hand with a wavy line above it, one solid black and one hollow. The bottom row signs are a hand with a lightning bolt above it and a hand with a lightning bolt above it, one solid black and one hollow.</p>



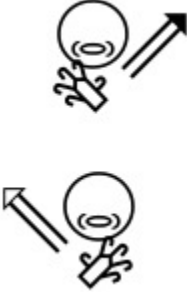

ASL Bible Dictionary

Spoken Word	SignWriting
scorch	
scorn	
scorpion	
scorpions	
Scotland	
Scott	

ASL Bible Dictionary

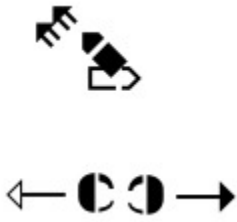
Spoken Word	SignWriting
scowl	
scowl	
scratchy	
scream	
screaming	
screaming	
screaming	

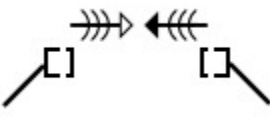

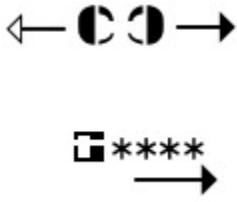



ASL Bible Dictionary

Spoken Word	SignWriting
Scripture	
scroll	
scroll	
scroll	
scroll	
scroll	

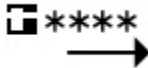





ASL Bible Dictionary

Spoken Word	SignWriting
scroll	<p>The signwriting for 'scroll' consists of a vertical sequence of symbols: a square, a circle with a horizontal line through its center, a square with a diagonal line from the top-left to the bottom-right, a solid black circle, a horizontal line, a square with a horizontal line extending to the left, and another square with a horizontal line extending to the left.</p>
scroll	<p>The signwriting for 'scroll' consists of a horizontal sequence of symbols: a left-pointing arrow, a circle with a horizontal line through its center, another circle with a horizontal line through its center, and a right-pointing arrow.</p>
scrutinize	<p>The signwriting for 'scrutinize' consists of two parts. The top part is a magnifying glass icon. The bottom part is a horizontal sequence of symbols: a left-pointing arrow, a square with a horizontal line extending to the left, a square with a horizontal line extending to the right, another square with a horizontal line extending to the right, and a right-pointing arrow.</p>
SDSU	<p>The signwriting for 'SDSU' consists of a vertical sequence of symbols: a square, a horizontal line, a solid black circle, a square, another square, and a square with a horizontal line extending to the left.</p>
sea	<p>The signwriting for 'sea' consists of two parts. The top part is a magnifying glass icon. The bottom part is a horizontal sequence of symbols: a diamond, a U-shaped symbol with a triangle pointing right inside, another U-shaped symbol with a triangle pointing right inside, and another diamond.</p>
sea	<p>The signwriting for 'sea' consists of a vertical sequence of symbols: a square, a square with a horizontal line extending to the left, and another square with a horizontal line extending to the left.</p>
seal	<p>The signwriting for 'seal' consists of a horizontal sequence of symbols: a left-pointing arrow, a square with a horizontal line extending to the left, and a square with a horizontal line extending to the left.</p>

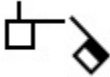
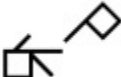
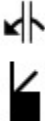

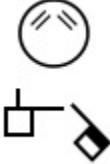
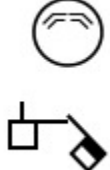

ASL Bible Dictionary

Spoken Word	SignWriting
seals	
seam	
search	
season	
seats	
seaweed	
Seba	







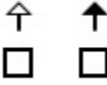



ASL Bible Dictionary

Spoken Word	SignWriting
second	
second	
second	
second	
second	
second	
second	
second	
secondly	
secret	

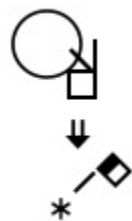







ASL Bible Dictionary

Spoken Word	SignWriting
secret	
secretary	
sect	
secular	
Secundus	
secure	





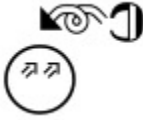

ASL Bible Dictionary

Spoken Word	SignWriting
see	
see	
see	
see	
see	
see	
see	
see	
see	
see	

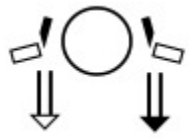



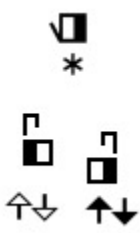

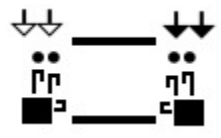
ASL Bible Dictionary

Spoken Word	SignWriting
see-down	
seed	
seed	
seed-fall	
seeds	
seeds	
seek	
seem	

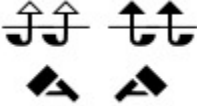

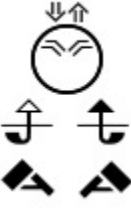





ASL Bible Dictionary

Spoken Word	SignWriting
self	
Self	
self	
self	
self	
self-control	
self-right	
selfish	

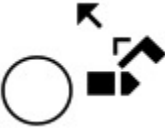



ASL Bible Dictionary

Spoken Word	SignWriting
sell	
sell	
sell	
Semein	
semicolon	
seminary	

ASL Bible Dictionary

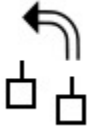
Spoken Word	SignWriting
Senaah	
Senate	
send	
send	
send	
send	
send	
sends	
sends	

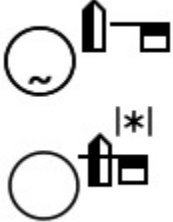

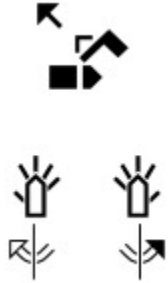

ASL Bible Dictionary

Spoken Word	SignWriting
senior	
senior	
sense	
senses	
sensitive	
sensitive	
sent	



ASL Bible Dictionary

Spoken Word	SignWriting
sent	<p>The signwriting for 'sent' consists of three parts: a top part with a square, a diamond, and an arrow pointing up and right; a middle part with two hand icons, each with a vertical line and a horizontal line; and a bottom part with two hand icons, each with a vertical line and a horizontal line.</p>
sentence	<p>The signwriting for 'sentence' consists of two hand icons, each with a vertical line and a horizontal line, followed by a horizontal line with three arrows pointing to the right.</p>
sentence	<p>The signwriting for 'sentence' consists of a horizontal line with three arrows pointing to the left, followed by two hand icons, each with a vertical line and a horizontal line, followed by a horizontal line with three arrows pointing to the right.</p>
separate	<p>The signwriting for 'separate' consists of a horizontal line with an arrow pointing to the left, followed by two hand icons, each with a vertical line and a horizontal line, followed by a horizontal line with an arrow pointing to the right.</p>
Sephar	<p>The signwriting for 'Sephar' consists of a vertical sequence of symbols: a square, a horizontal line, a diamond, a hand icon with a vertical line and a horizontal line, a hand icon with a vertical line and a horizontal line, and a hand icon with a vertical line and a horizontal line.</p>
September	<p>The signwriting for 'September' consists of a vertical sequence of symbols: a square, a horizontal line, a diamond, a hand icon with a vertical line and a horizontal line, and a hand icon with a vertical line and a horizontal line.</p>
Serah	<p>The signwriting for 'Serah' consists of a vertical sequence of symbols: a square, a horizontal line, a hand icon with a vertical line and a horizontal line, a hand icon with a vertical line and a horizontal line, and a hand icon with a vertical line and a horizontal line.</p>







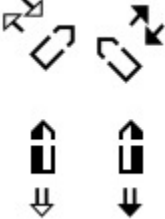
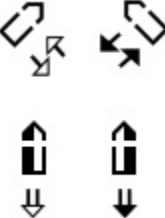
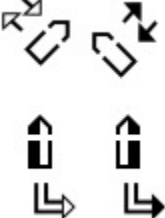
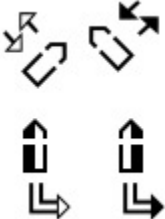

ASL Bible Dictionary

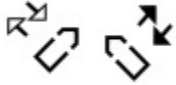
Spoken Word	SignWriting
Seraiah	
Sered	
Sergius	
series	
serious	

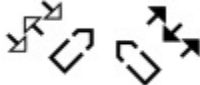



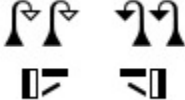

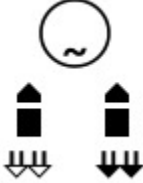
ASL Bible Dictionary

Spoken Word	SignWriting
serious	
Serug	
servant	
servant	
servants	
servants	



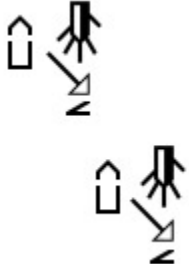
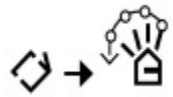
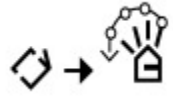

ASL Bible Dictionary

Spoken Word	SignWriting
serve	
serve	
serve	
serve	
sesame	
set-aside	
set-down	
Seth	
settle	

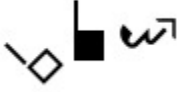
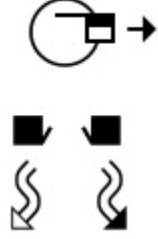

ASL Bible Dictionary

Spoken Word	SignWriting
Seven	
seventh	
sever-roots	
several	
several	
sew to right	
sewer	
sex	





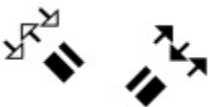
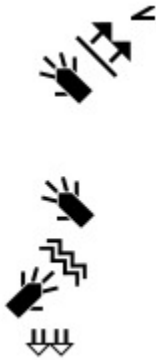
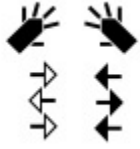
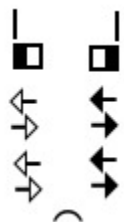
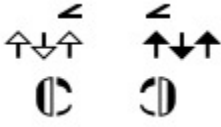

ASL Bible Dictionary

Spoken Word	SignWriting
shadow	
shadow	
shadow	
shadow	
Shadrach	
Shadrach	



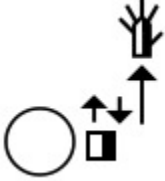



ASL Bible Dictionary

Spoken Word	SignWriting
shaft	
shake	
shake	
shake	
shake	
shake	
shake	

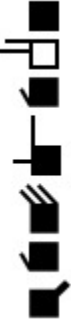

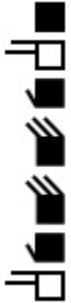



ASL Bible Dictionary

Spoken Word	SignWriting
shake-fists	
shake-off	
Shake-spear	
Shalem	
shall	
shallow	
Shallum	





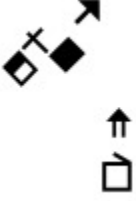
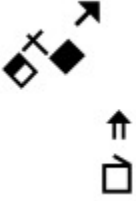

ASL Bible Dictionary

Spoken Word	SignWriting
Shalmi	
shame	
Shammah	
Shammua	
shape	
shapes	
share	



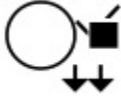

ASL Bible Dictionary

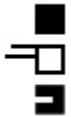
Spoken Word	SignWriting
share	
share	
Sharon	
sharp	
sharper	
sharper	
sharpest	





ASL Bible Dictionary

Spoken Word	SignWriting
Shaul	
shave	
shaved	
Shaveh	
Shaveh	
she	
she	
she	

ASL Bible Dictionary

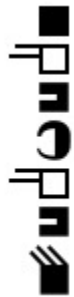
Spoken Word	SignWriting
sheave	
sheaves	
Sheba	
Shebah	
Shebaniah	



ASL Bible Dictionary

Spoken Word	SignWriting
Shecaniah	
Shechem	
Sheep	
sheep	
sheet	

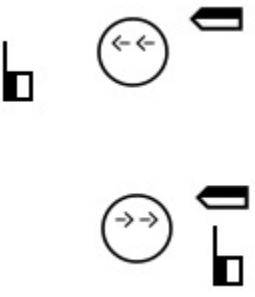

ASL Bible Dictionary

Spoken Word	SignWriting
sheet	
sheets	
shekels	
Shelah	
Shelemiah	



ASL Bible Dictionary

Spoken Word	SignWriting
Sheleph	
shelter	
shelters	
Shem	



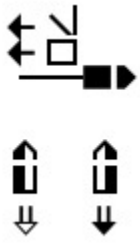

ASL Bible Dictionary

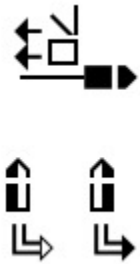
Spoken Word	SignWriting
Shemaiah	
Shemeber	
Shephatiah	



ASL Bible Dictionary

Spoken Word	SignWriting
shepherd	 <p>The SignWriting for 'shepherd' consists of four distinct signs arranged vertically. The top sign is a complex shape with a square, a triangle, and a horizontal line, with arrows indicating movement. The second sign is a similar shape with a diagonal line. The third sign is a simple curved shape. The fourth sign consists of two separate vertical shapes, each with a downward-pointing arrow.</p>
shepherd	 <p>The SignWriting for 'shepherd' consists of three signs. The top sign is the same complex shape as in the first row. The bottom two signs are the same two separate vertical shapes with downward arrows as in the first row.</p>
shepherds	 <p>The SignWriting for 'shepherds' consists of four signs. The top sign is the complex shape. The second sign is the diagonal shape. The third sign is the curved shape. The bottom sign consists of two separate vertical shapes, each with a downward-pointing arrow and a small horizontal line at the bottom.</p>
shepherds	 <p>The SignWriting for 'shepherds' consists of three signs. The top sign is the complex shape. The bottom two signs are the two separate vertical shapes with downward arrows and horizontal lines at the bottom.</p>



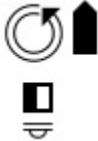

ASL Bible Dictionary

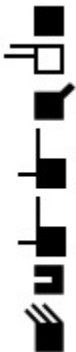
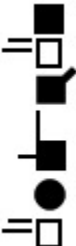
Spoken Word	SignWriting
Shepho	
Sherebiah	
Shethar	
Shew	
shh	





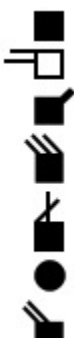

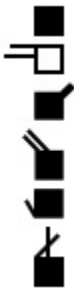
ASL Bible Dictionary

Spoken Word	SignWriting
shhh	
shield	
shield	
shields	
Shillem	
Shiloh	



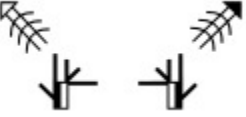



ASL Bible Dictionary

Spoken Word	SignWriting
Shimea	
Shimei	
Shimron	
Shinab	
Shinar	



ASL Bible Dictionary

Spoken Word	SignWriting
Shinar	
shine	
shines	
shining	
ship	
ship	
Shiphrah	

ASL Bible Dictionary

Spoken Word	SignWriting
ships	
shirt	
shirts	
shoal	
shoal	
Shobai	
Shobal	









ASL Bible Dictionary

Spoken Word	SignWriting
Shobek	 The SignWriting for 'Shobek' consists of a vertical sequence of five symbols: a solid black square, a square with a horizontal line extending to the left, a solid black circle, a square with a horizontal line extending to the right, and a square with a horizontal line extending to the right and a vertical line extending downwards from the center.
shocked	 The SignWriting for 'shocked' consists of a vertical sequence of three symbols: a circle containing two smaller circles, a square with a horizontal line extending to the left, and a square with a horizontal line extending to the right and a vertical line extending downwards from the center.







ASL Bible Dictionary

Spoken Word	SignWriting
shocked	<p>The sign for 'shocked' is composed of three parts: a circle with a horizontal line through it, a diamond shape to its right, a downward arrow, and two hands with fingers spread.</p>
shoes	<p>The sign for 'shoes' consists of two arrows pointing outwards from a central point, followed by two thick horizontal bars, and two arrows pointing inwards towards the bars.</p>
shoes-put-on	<p>The sign for 'shoes-put-on' is shown in two stages. The first stage shows a shoe icon, a downward arrow, and a small circle with an '@' symbol. The second stage shows a shoe icon, a downward arrow, and a small circle with an '@' symbol, indicating the action of putting on the shoe.</p>
shore	<p>The sign for 'shore' involves a hand holding a rectangular object, with arrows indicating movement and a hand with fingers spread.</p>
shore	<p>The sign for 'shore' is similar to the previous one, showing a hand with a rectangular object and arrows, but with a different hand gesture.</p>
short	<p>The sign for 'short' consists of two diamond shapes and an arrow pointing upwards and to the right.</p>
shorter	<p>The sign for 'shorter' consists of two diamond shapes and an arrow pointing upwards and to the right, followed by a separate sign consisting of an upward arrow and a diamond shape.</p>



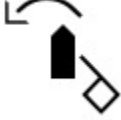



ASL Bible Dictionary

Spoken Word	SignWriting
shorthand	
should	
shoulder	
shoulders	
shout	
shout	
shout	
shout	

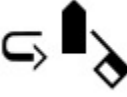
ASL Bible Dictionary

Spoken Word	SignWriting
shouting	
shouting	
shouting	
show	
show	
show	
show	
show	

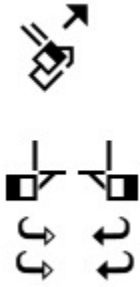
ASL Bible Dictionary

Spoken Word	SignWriting
show	
show	
show-up	
shower	
shrine	
shrines	
shrink	





ASL Bible Dictionary

Spoken Word	SignWriting
shrink	<p>The signwriting for 'shrink' consists of three vertical elements: a small black square at the top, a zigzag line in the middle, and a hand icon with the index finger pointing up at the bottom.</p>
shrug	<p>The signwriting for 'shrug' features a horizontal bracket at the top, two hand icons in the middle with fingers spread, and two downward-pointing arrows at the bottom.</p>
shrug	<p>The signwriting for 'shrug' features a horizontal bracket at the top and two hand icons in the middle with fingers spread.</p>
Shuah	<p>The signwriting for 'Shuah' is a vertical sequence of five elements: a hand icon with the index finger pointing up, a horizontal line, a hand icon with the index finger pointing down, a horizontal line, and a hand icon with the index finger pointing up.</p>
shual	<p>The signwriting for 'shual' is a vertical sequence of five elements: a hand icon with the index finger pointing up, a horizontal line, a hand icon with the index finger pointing down, a horizontal line, and a hand icon with the index finger pointing up.</p>
Shuni	<p>The signwriting for 'Shuni' is a vertical sequence of four elements: a hand icon with the index finger pointing up, a horizontal line, a hand icon with the index finger pointing down, and a hand icon with the index finger pointing up.</p>



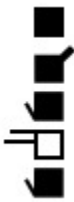

ASL Bible Dictionary

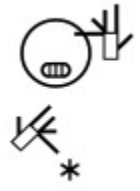
Spoken Word	SignWriting
Shur	
Shushan	
shut up	
shut-mouth	
shut-up	
shuttle	





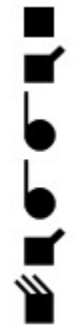
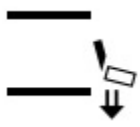
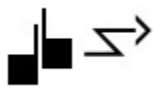

ASL Bible Dictionary

Spoken Word	SignWriting
Siaha	
Siberia	
Sichem	
sick	
sick	
sick	

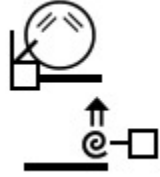



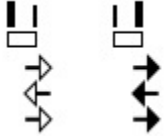

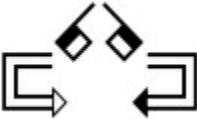
ASL Bible Dictionary

Spoken Word	SignWriting
sickle	
sickle	
Siddim	
side-body	
side-by-side	
side-look	

ASL Bible Dictionary

Spoken Word	SignWriting
side-scar	
sidehand	
sidetracked	
Sidon	
sift	
sift	
sight	
sign	

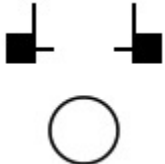
ASL Bible Dictionary

Spoken Word	SignWriting
sign	
sign	
sign	
sign	
sign	
sign	
Sign Writing	
signed	





ASL Bible Dictionary

Spoken Word	SignWriting
signer	<p>The SignWriting for 'signer' consists of two rows of handshapes. The top row shows two hands in a 'V' shape, with the left hand palm facing left and the right hand palm facing right. Below this, there are two circular arrows, one on each side, pointing clockwise. The bottom row shows two hands in a 'U' shape, with the left hand palm facing left and the right hand palm facing right. Below this, there are two downward-pointing arrows, one on each side.</p>
signers	<p>The SignWriting for 'signers' consists of two rows of handshapes. The top row shows two hands in a 'V' shape, with the left hand palm facing left and the right hand palm facing right. Below this, there are two circular arrows, one on each side, pointing clockwise. The bottom row shows two hands in a 'U' shape, with the left hand palm facing left and the right hand palm facing right. Below this, there are two downward-pointing arrows, one on each side, with a small L-shaped arrow pointing to the right at the bottom of each.</p>
signs	<p>The SignWriting for 'signs' consists of a single handshape. The hand is in a 'V' shape, with the left hand palm facing left and the right hand palm facing right. A curved arrow above the hand indicates a clockwise rotation.</p>
SignWriter	<p>The SignWriting for 'SignWriter' consists of three rows of handshapes. The top row shows two hands in a 'V' shape, with the left hand palm facing left and the right hand palm facing right. Below this, there are two circular arrows, one on each side, pointing clockwise. The middle row shows a hand in a 'U' shape, with the palm facing left. Below this, there is a curved arrow pointing to the right, followed by a downward-pointing arrow. The bottom row shows two hands in a 'U' shape, with the left hand palm facing left and the right hand palm facing right. Below this, there are two downward-pointing arrows, one on each side.</p>



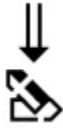

ASL Bible Dictionary

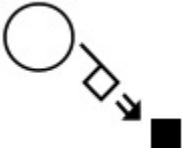
Spoken Word	SignWriting
SignWriting	<p>The SignWriting for 'SignWriting' consists of two parts. The first part shows the sign for 'SIGN' (two hands, palms facing each other, fingers pointing up) followed by the sign for 'WRITING' (two hands, palms facing each other, fingers pointing down). The second part shows the sign for 'SIGN' followed by the sign for 'WRITING' with a downward-pointing arrow indicating the direction of the movement.</p>
signwriting	<p>The SignWriting for 'signwriting' consists of the sign for 'SIGN' (two hands, palms facing each other, fingers pointing up) followed by the sign for 'WRITING' (two hands, palms facing each other, fingers pointing down).</p>
signwriting	<p>The SignWriting for 'signwriting' consists of the sign for 'SIGN' (two hands, palms facing each other, fingers pointing up) followed by the sign for 'WRITING' (two hands, palms facing each other, fingers pointing down) with a downward-pointing arrow indicating the direction of the movement.</p>
Sihon	<p>The SignWriting for 'Sihon' consists of the sign for 'SIGN' (two hands, palms facing each other, fingers pointing up) followed by the sign for 'WRITING' (two hands, palms facing each other, fingers pointing down) with a downward-pointing arrow indicating the direction of the movement.</p>
Silas	<p>The SignWriting for 'Silas' consists of the sign for 'SIGN' (two hands, palms facing each other, fingers pointing up) followed by the sign for 'WRITING' (two hands, palms facing each other, fingers pointing down).</p>



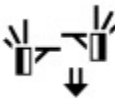

ASL Bible Dictionary

Spoken Word	SignWriting
silence	
silence	
silent	
silk	
silly	
Siloam	
silver	

ASL Bible Dictionary

Spoken Word	SignWriting
Simeon	
simmer	
Simon	
Simon	
simple-mind	
simply	

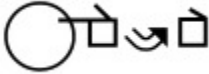
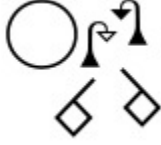



ASL Bible Dictionary

Spoken Word	SignWriting
sin	
sin	
Sinai	
since	
since	
sinew	
sing	



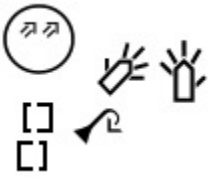

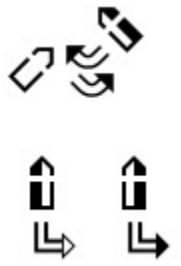
ASL Bible Dictionary

Spoken Word	SignWriting
sing	



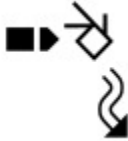
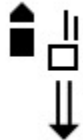



ASL Bible Dictionary

Spoken Word	SignWriting
sing	
sing	
sing	
singers	
single	
Sinite	





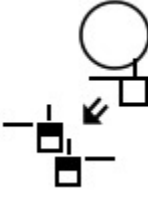
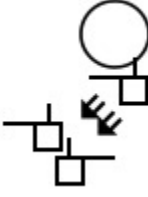

ASL Bible Dictionary

Spoken Word	SignWriting
Sinite	
sink	
sink	
sinking	
sinner	
sinners	

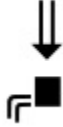



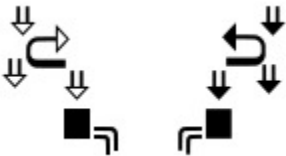

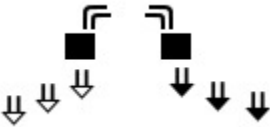

ASL Bible Dictionary

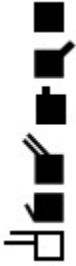
Spoken Word	SignWriting
sinning	
sins	
sins	
Sisera	
sister	
sisters	
sit	

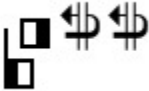

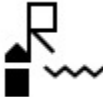



ASL Bible Dictionary

Spoken Word	SignWriting
sit	
sit	
sit	
sit	
sit-down	
sit-in-circle	
sit-in-doorway	
sit-slope	



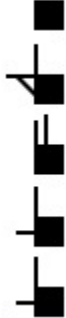





ASL Bible Dictionary

Spoken Word	SignWriting
sit-weary	
Sitnah	
situation	
situations	
Six	
skateboard	
skill	
skills	
skin	



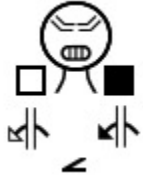

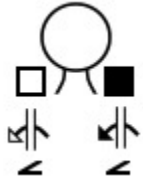

ASL Bible Dictionary

Spoken Word	SignWriting
skull	 
skull	
sky	
sky	
slander	
slap-face	





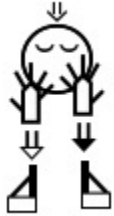

ASL Bible Dictionary

Spoken Word	SignWriting
slap-face	
slap-face	
slap-face	
slash	
slaughter	
slaughter	
slaughter	
slave	
slave	

ASL Bible Dictionary

Spoken Word	SignWriting
slave	
slave	
slaves	
sledges	
sleep	
sleep	
sleep	







ASL Bible Dictionary

Spoken Word	SignWriting
sleep	
sleep	
sleep	
sleep-around	
sling	
sling	
sling	

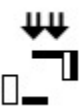



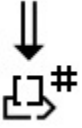

ASL Bible Dictionary

Spoken Word	SignWriting
slip	<p>The signwriting for 'slip' consists of two parts. The first part shows a hand with fingers spread, moving from a high position down to a lower position, with a downward arrow indicating the direction. The second part shows a hand with fingers spread, moving from a high position down to a lower position, with a downward arrow and a '#' symbol indicating the final position.</p>
slope	<p>The signwriting for 'slope' shows two small black squares side-by-side, with an arrow pointing upwards and to the right from the right square, indicating an upward slope.</p>
Slovakian	<p>The signwriting for 'Slovakian' shows a circle with a dot inside, a hand with fingers spread, and a wavy line with an arrow pointing upwards and to the right.</p>
Slovakian	<p>The signwriting for 'Slovakian' shows a circle with a dot inside, a hand with fingers spread, and a wavy line with an arrow pointing upwards and to the right.</p>
slow	<p>The signwriting for 'slow' shows a hand with fingers spread, moving from a high position down to a lower position, with a downward arrow and a '#' symbol indicating the final position.</p>
slow	<p>The signwriting for 'slow' shows a hand with fingers spread, moving from a high position down to a lower position, with a downward arrow and a '#' symbol indicating the final position.</p>







ASL Bible Dictionary

Spoken Word	SignWriting
smackfly	
small	
small	
smallest	
smart	
smash	
smile	
smile	

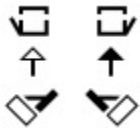

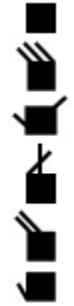

ASL Bible Dictionary

Spoken Word	SignWriting
smile	
smile	
smith	
smoke	
smoke	
smoke	
smooth	

ASL Bible Dictionary

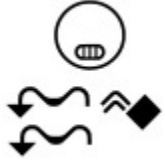
Spoken Word	SignWriting
smooth	
smooze	
Smyrna	
snake	
snake	
snake-jump	
snakes	



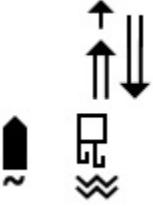
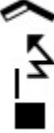

ASL Bible Dictionary

Spoken Word	SignWriting
snakes	
snare	
snarl	
snatch	
sneak	
sneak-over-wall	
sneaky	

ASL Bible Dictionary

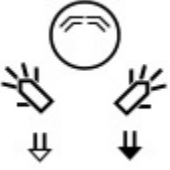
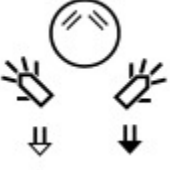
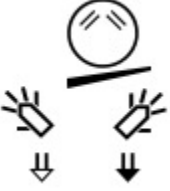
Spoken Word	SignWriting
sniff	<p>The signwriting for 'sniff' consists of a circle containing a cross symbol (†) at the top. Below it are three asterisks (***) and a square with an arrow pointing to the right.</p>
snooty	<p>The signwriting for 'snooty' features a circle with a vertical line through its center. Below the circle is a square with a vertical line extending downwards from its top edge. To the right of this square are two upward-pointing arrows (↑↑).</p>
snow	<p>The signwriting for 'snow' is a vertical sequence of symbols: a square with a diagonal line from the top-left to the bottom-right, an upward-pointing arrow (↑), a hand with fingers spread and a small asterisk (*) below it, two wavy lines representing snow, and two hands with fingers spread and downward-pointing arrows (⇩) below them.</p>
snuffed	<p>The signwriting for 'snuffed' consists of two parts. The top part shows a hand with fingers spread, a wavy line above it, and a square below it. The bottom part shows a hand with fingers spread, a circle with a vertical line through its center, and a hand with fingers spread below it.</p>
snuffed-out	<p>The signwriting for 'snuffed-out' shows two hands with fingers spread and downward-pointing arrows (⇩) below them. Below these are two squares with diagonal lines from the top-left to the bottom-right.</p>
so	<p>The signwriting for 'so' consists of two hands with fingers spread and downward-pointing arrows (⇩) below them.</p>

ASL Bible Dictionary

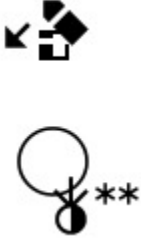
Spoken Word	SignWriting
SO	
SO	
SO	
SO	
SO-SO	
so-that	
soak	







ASL Bible Dictionary

Spoken Word	SignWriting
soak-sponge	<p>The signwriting consists of a circle with a vertical line through it, followed by two vertical arrows (one pointing down, one pointing up), and a hand icon with a sponge-like shape on the palm.</p>
soak-sponge	<p>The signwriting consists of a circle with a vertical line through it, followed by a single vertical arrow pointing down, and a hand icon with a sponge-like shape on the palm.</p>
soaks	<p>The signwriting consists of a hand icon with fingers spread, a square, a vertical arrow pointing down, and a triangle.</p>
soap	<p>The signwriting consists of a sequence of shapes: a square with a diagonal line, a square, a vertical arrow pointing down, and a horizontal line.</p>
soap	<p>The signwriting consists of a square, a circle, a square, and a diamond.</p>
soda	<p>The signwriting consists of a vertical arrow pointing up, a hand icon with fingers spread, a vertical arrow pointing down, and a diamond.</p>
soda	<p>The signwriting consists of a square, a circle, a horizontal line, and a square.</p>

ASL Bible Dictionary

Spoken Word	SignWriting
soda	<p>The SignWriting for 'soda' consists of a vertical sequence of symbols: a square, a circle, a horizontal line, a circle, and a square with a diagonal line.</p>
Sodom	<p>The SignWriting for 'Sodom' consists of a vertical sequence of symbols: a square, a circle, a horizontal line, a circle, a circle, and a hand with fingers spread.</p>
soft	<p>The SignWriting for 'soft' consists of two hand symbols. Each hand has a diamond shape with a downward arrow above it, and a horizontal line with three downward arrows below it.</p>
soft	<p>The SignWriting for 'soft' consists of two hand symbols. Each hand has a diamond shape with a downward arrow above it, and a horizontal line with three downward arrows below it.</p>
soil	<p>The SignWriting for 'soil' consists of two hand symbols. Each hand has a circle with a counter-clockwise arrow above it, and a horizontal line with a vertical line extending downwards from its center.</p>
solar	<p>The SignWriting for 'solar' consists of a vertical sequence of symbols: a square, a circle, a horizontal line, a square, a square with a diagonal line, and a square with a diagonal line.</p>







ASL Bible Dictionary

Spoken Word	SignWriting
solar-wind	
soldiers	
Solomon	
Solomon	
some	
someone	
someone	

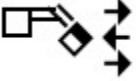

ASL Bible Dictionary

Spoken Word	SignWriting
something	
sometimes	
sometimes	
son	
son	
son	
songs	
sons	

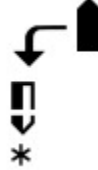
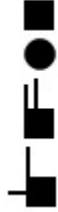
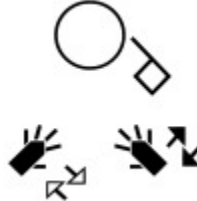
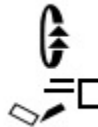

ASL Bible Dictionary

Spoken Word	SignWriting
soon	
soon	
soon	
Sopater	
Sophia	
Sophia	



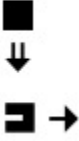
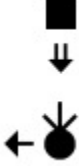

ASL Bible Dictionary

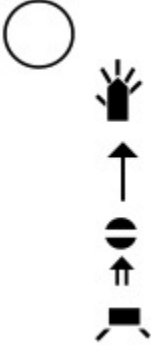
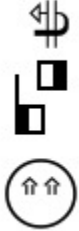
Spoken Word	SignWriting
soul	
soul	
soul	
sound	
soup	
sour	
south	

ASL Bible Dictionary

Spoken Word	SignWriting
southeast	
southwest	
soviet	
SOW	
space	

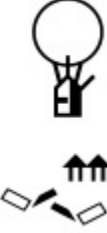
ASL Bible Dictionary

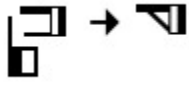
Spoken Word	SignWriting
speak	
speak	
speak	
speakeasy	
speaker	
spear	
spearhead	

ASL Bible Dictionary

Spoken Word	SignWriting
special	<p>The signwriting for 'special' consists of a vertical line with a small square at the bottom, a horizontal line extending to the right from the top of the vertical line, and an upward-pointing arrow above the horizontal line.</p>
specific	<p>The signwriting for 'specific' consists of a vertical line with a small square at the bottom, a horizontal line extending to the right from the top of the vertical line, and an arrow pointing to the left above the horizontal line.</p>
speckled	<p>The signwriting for 'speckled' consists of a circle above a horizontal line, with two hands below the line, each with small circles (speckles) around it.</p>
spectral	<p>The signwriting for 'spectral' consists of a vertical sequence of symbols: a diamond, a circle, a square, a horizontal line, a square, a horizontal line, a square, a horizontal line, a square, a horizontal line, and a square.</p>
spectrum	<p>The signwriting for 'spectrum' consists of a hand holding a sphere with wavy lines inside, positioned above a horizontal line with a zigzag pattern. Below this are several symbols: a square with a horizontal line, a diamond, a square, a horizontal line, a square, a horizontal line, a square, a horizontal line, a square, a horizontal line, and a square.</p>

ASL Bible Dictionary

Spoken Word	SignWriting
spectrum	<p>The signwriting for 'spectrum' consists of a vertical sequence of symbols: a diamond with a diagonal slash, the letter 'S', a circle, a square, a diamond with a diagonal slash, a square, a horizontal line, and a hand with fingers spread.</p>
spend	<p>The signwriting for 'spend' consists of a vertical sequence of symbols: a diamond with a diagonal slash, an upward-pointing arrow, and a diamond with a diagonal slash.</p>
spicery	<p>The signwriting for 'spicery' consists of a vertical sequence of symbols: a diamond with a diagonal slash, a square, a circle, a square, a diamond with a diagonal slash, a square, and a hand with fingers spread.</p>
spices	<p>The signwriting for 'spices' consists of a vertical sequence of symbols: a diamond with a diagonal slash, a square, a circle, a square, and a square.</p>
spider	<p>The signwriting for 'spider' consists of two upward-pointing arrows above a hand with fingers spread, with a star symbol below the hand.</p>







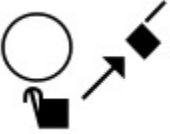
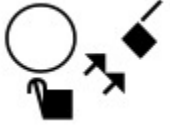

ASL Bible Dictionary

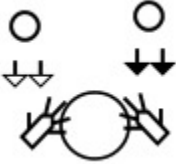
Spoken Word	SignWriting
spies	<p>The SignWriting for 'spies' consists of a hand sign for 'spy' (a hand with fingers spread, palm facing left) and a hand sign for 'spy' (a hand with fingers spread, palm facing right). A circle with two arrows pointing left and right is positioned above the second hand sign.</p>
spilled	<p>The SignWriting for 'spilled' consists of a hand sign for 'spill' (a hand with fingers spread, palm facing left) and a hand sign for 'spill' (a hand with fingers spread, palm facing right). A circle with a vertical line through it is positioned above the second hand sign.</p>
spirit	<p>The SignWriting for 'spirit' consists of a hand sign for 'spirit' (a hand with fingers spread, palm facing left) and a hand sign for 'spirit' (a hand with fingers spread, palm facing right). A circle with a vertical line through it is positioned above the second hand sign.</p>
spirit	<p>The SignWriting for 'spirit' consists of a hand sign for 'spirit' (a hand with fingers spread, palm facing left) and a hand sign for 'spirit' (a hand with fingers spread, palm facing right). A circle with a vertical line through it is positioned above the second hand sign.</p>
spirits	<p>The SignWriting for 'spirits' consists of a hand sign for 'spirit' (a hand with fingers spread, palm facing left) and a hand sign for 'spirit' (a hand with fingers spread, palm facing right). A circle with a vertical line through it is positioned above the second hand sign.</p>
spit	<p>The SignWriting for 'spit' consists of a hand sign for 'spit' (a hand with fingers spread, palm facing left) and a hand sign for 'spit' (a hand with fingers spread, palm facing right). A circle with a vertical line through it is positioned above the second hand sign.</p>
spit	<p>The SignWriting for 'spit' consists of a hand sign for 'spit' (a hand with fingers spread, palm facing left) and a hand sign for 'spit' (a hand with fingers spread, palm facing right). A circle with a vertical line through it is positioned above the second hand sign.</p>





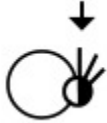

ASL Bible Dictionary

Spoken Word	SignWriting
spit	
spit	

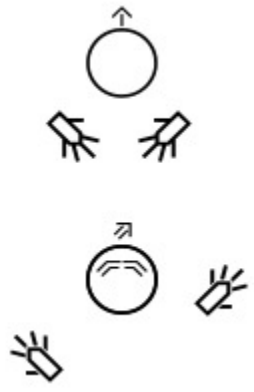

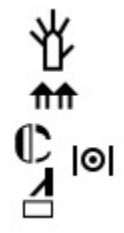

ASL Bible Dictionary

Spoken Word	SignWriting
splatter-face	
spoiled	
sponge	
sponge	
sponge-to-lips	
sponsor	
spot	
spotted	



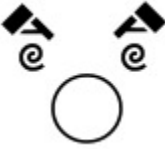

ASL Bible Dictionary

Spoken Word	SignWriting
sprawl	
spread	
spread	
spread	
spring	
Spring	



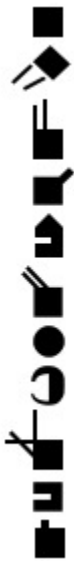



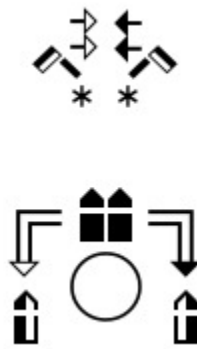

ASL Bible Dictionary

Spoken Word	SignWriting
sprinkle	
sprinkled	
Sprint	
spy	
square	



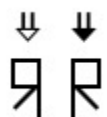
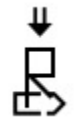

ASL Bible Dictionary

Spoken Word	SignWriting
Squibnocket	
squiggly	
St. Clair Shores Church	
stab	
stable	



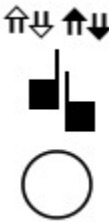
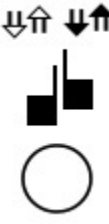
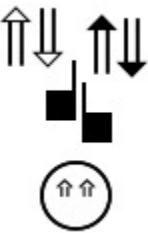

ASL Bible Dictionary

Spoken Word	SignWriting
stairway	
stamp	
stand	
stand	
stand	
stand	
stand	
stand up	
stand-at-door	



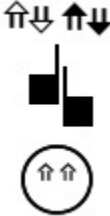

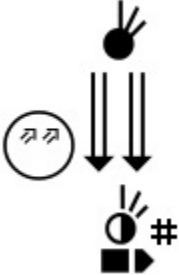
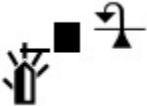

ASL Bible Dictionary

Spoken Word	SignWriting
stand-up	
standing	
Star	
star	
star	
star	
star-rise	



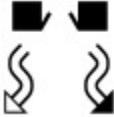

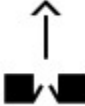

ASL Bible Dictionary

Spoken Word	SignWriting
stare	
stars	
stars	
stars	
stars-fall	
start	
starting-now	







ASL Bible Dictionary

Spoken Word	SignWriting
stat	
state	
states	
statue	
status	
stay	
stay	
stay	



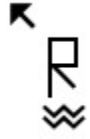

ASL Bible Dictionary

Spoken Word	SignWriting
stay	
stay	
stay	
steal	
steal	
steals	
stele	



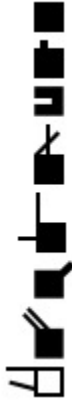

ASL Bible Dictionary

Spoken Word	SignWriting
stem	
stench	
step	
step	
step	
step	
Stephanas	

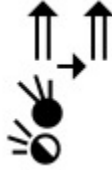

ASL Bible Dictionary

Spoken Word	SignWriting
Stephen	
steps	
sterling	
steroid	
stick	

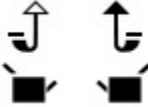
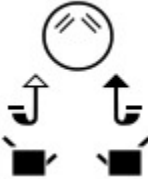

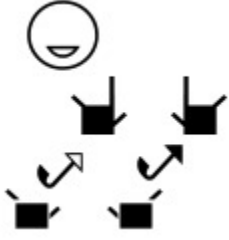
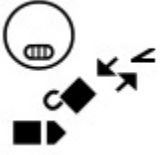
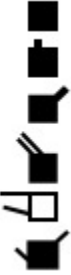

ASL Bible Dictionary

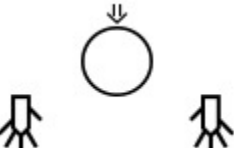
Spoken Word	SignWriting
stick	
sticks	
sticks	
sticks	
sticky	
still	
still	



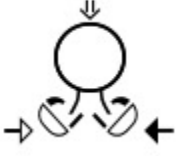

ASL Bible Dictionary

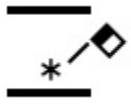
Spoken Word	SignWriting
still-love	
sting	
stingy	
stock	
stocks	
stocks	



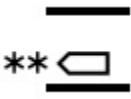

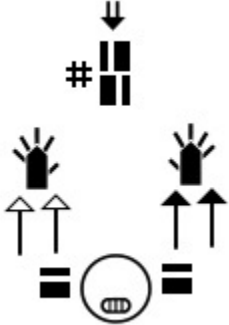
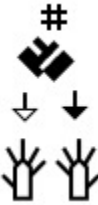

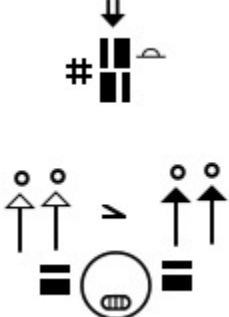
ASL Bible Dictionary

Spoken Word	SignWriting
stocks	
Stoic	
Stokoe	
Stokoe	
stomach	





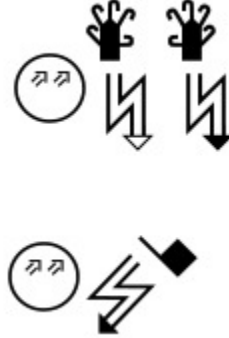

ASL Bible Dictionary

Spoken Word	SignWriting
stomach	
stone	
stone	
stone	
stone-fall	
stones	
stoning	

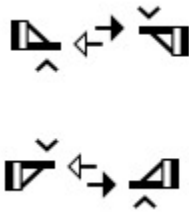
ASL Bible Dictionary

Spoken Word	SignWriting
stool	
stoop	
stoop	
stop	
stop	
stop	
storm	





ASL Bible Dictionary

Spoken Word	SignWriting
story	
story	
straight	
straight	
Straight	
strain	
Strait	



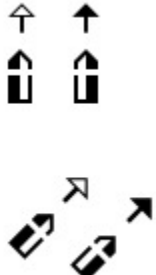

ASL Bible Dictionary

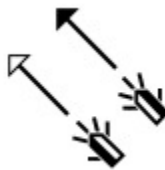
Spoken Word	SignWriting
strange	
stranger	
strangers	
straw	
strawberry	
stream	



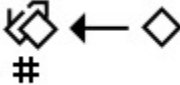
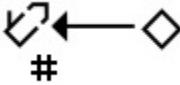
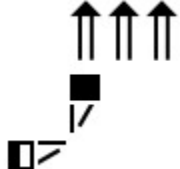

ASL Bible Dictionary

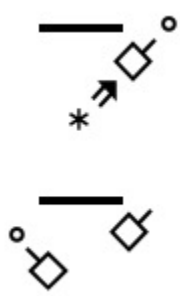
Spoken Word	SignWriting
street	
streets	
strength	
stress	
stretch	
stretch	
stretch-hands	

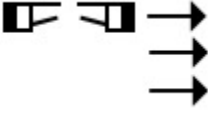

ASL Bible Dictionary

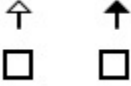
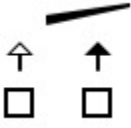
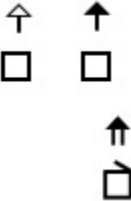
Spoken Word	SignWriting
stretched	
strict	
strike	
strike	
strike-palm	
strings	
strip	
strip	

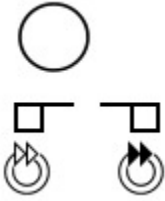
ASL Bible Dictionary

Spoken Word	SignWriting
strips	
stroke	
strong	
strong	
stronger	
structure	
struggle	

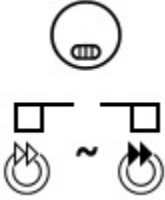
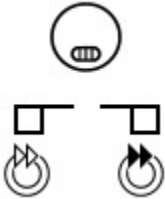
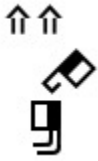
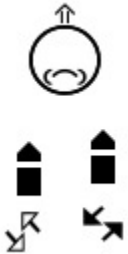
ASL Bible Dictionary

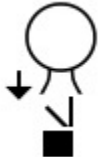
Spoken Word	SignWriting
struggle	
struggles	
strung-up	
strut	
stubble	
stuck	





ASL Bible Dictionary

Spoken Word	SignWriting
stuck	<p>The SignWriting for 'stuck' consists of a circle above a vertical line with an asterisk, and a square below the line.</p>
student	<p>The SignWriting for 'student' consists of a circle above a vertical line with an asterisk, a hand holding a book, and two vertical arrows pointing up and down.</p>
students	<p>The SignWriting for 'students' consists of a circle above a vertical line with an asterisk, a hand holding a book, and two vertical arrows pointing up and down, with a small arrow pointing right at the bottom of each.</p>
studies	<p>The SignWriting for 'studies' consists of a vertical line with several horizontal bars of varying lengths, and a circle at the bottom.</p>
study	<p>The SignWriting for 'study' consists of a hand holding a book, and a hand with a wavy line above it.</p>

ASL Bible Dictionary

Spoken Word	SignWriting
stumble	<p>The sign for 'stumble' is composed of two parts. The first part shows a hand with the index finger pointing up and to the right, with a small square above it. The second part shows a hand with the index finger pointing up and to the right, with a '#' symbol to its left.</p>
stumble	<p>The sign for 'stumble' is composed of two parts. The first part shows a hand with the index finger pointing up and to the right, with a small square above it. The second part shows a hand with the index finger pointing up and to the right, with a small square above it.</p>
stump	<p>The sign for 'stump' is composed of four parts. The first part shows a hand with the index finger pointing up and to the right, with a small square above it. The second part shows a hand with the index finger pointing up and to the right, with a small square above it. The third part shows a hand with the index finger pointing up and to the right, with a small square above it. The fourth part shows a hand with the index finger pointing up and to the right, with a small square above it.</p>
stupid	<p>The sign for 'stupid' is composed of two parts. The first part shows a hand with the index finger pointing up and to the right, with a small square above it. The second part shows a hand with the index finger pointing up and to the right, with a small square above it.</p>
style	<p>The sign for 'style' is composed of four parts. The first part shows a hand with the index finger pointing up and to the right, with a small square above it. The second part shows a hand with the index finger pointing up and to the right, with a small square above it. The third part shows a hand with the index finger pointing up and to the right, with a small square above it. The fourth part shows a hand with the index finger pointing up and to the right, with a small square above it.</p>
subject	<p>The sign for 'subject' is composed of two parts. The first part shows a hand with the index finger pointing up and to the right, with a small square above it. The second part shows a hand with the index finger pointing up and to the right, with a small square above it.</p>
subjects	<p>The sign for 'subjects' is composed of two parts. The first part shows a hand with the index finger pointing up and to the right, with a small square above it. The second part shows a hand with the index finger pointing up and to the right, with a small square above it.</p>



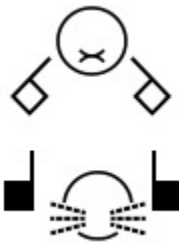

ASL Bible Dictionary

Spoken Word	SignWriting
suburb	
suburbs	
succeed	
success	
success	
success	

ASL Bible Dictionary

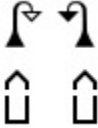
Spoken Word	SignWriting
success	<p>The SignWriting for 'success' consists of a central circle. To its left, two upward-pointing arrows are positioned above a diamond shape. To its right, two upward-pointing arrows are positioned above another diamond shape.</p>
Succoth	<p>The SignWriting for 'Succoth' is a vertical sequence of symbols: a solid black square at the top, followed by a square with a horizontal line through its center, then a solid black circle, another square with a horizontal line through its center, and finally a square with a horizontal line through its center and a small vertical line extending downwards from its bottom edge.</p>
such	<p>The SignWriting for 'such' consists of a solid black square at the top, with two upward-pointing arrows positioned directly below it.</p>
suck	<p>The SignWriting for 'suck' features a central diamond shape. To its left, a diagonal line points downwards and to the left. To its right, a diagonal line points downwards and to the right. Below the diamond, there are two upward-pointing arrows.</p>
sudden	<p>The SignWriting for 'sudden' consists of a circle at the top with three horizontal lines inside it. Below the circle are two solid black squares, one on the left and one on the right. Underneath each square is an upward-pointing arrow.</p>
suffer	<p>The SignWriting for 'suffer' consists of a circle at the top with a diamond shape inside it. Below this is a vertical line with several horizontal tick marks extending to the right, resembling a comb or a set of teeth.</p>
suffer	<p>The SignWriting for 'suffer' consists of a circle at the top with a diamond shape inside it. Below this is a vertical line with several horizontal tick marks extending to the left, resembling a comb or a set of teeth.</p>

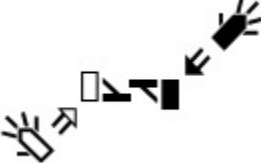
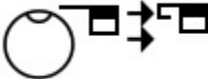
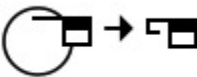

ASL Bible Dictionary

Spoken Word	SignWriting
suggest	
suggest	
sulfur	
sulk	
sum	
summer	
summer	





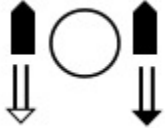
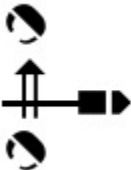
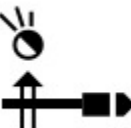

ASL Bible Dictionary

Spoken Word	SignWriting
summon	<p>The signwriting for 'summon' consists of a circle containing two small squares, followed by a vertical sequence of three hand shapes: a hand with fingers spread, a hand with fingers spread and a horizontal line, and a hand with fingers spread.</p>
summon	<p>The signwriting for 'summon' consists of a vertical sequence of three hand shapes: a hand with fingers spread, a hand with fingers spread and a horizontal line, and a hand with fingers spread.</p>
summon	<p>The signwriting for 'summon' consists of a vertical sequence of three hand shapes: a hand with fingers spread, a hand with fingers spread and a horizontal line, and a hand with fingers spread.</p>
summon me	<p>The signwriting for 'summon me' consists of a hand with fingers spread, followed by a hand with fingers spread and a horizontal line, and finally an upward-pointing arrow.</p>
summons	<p>The signwriting for 'summons' consists of a vertical sequence of three hand shapes: a hand with fingers spread, a hand with fingers spread and a horizontal line, and a hand with fingers spread.</p>
sun	<p>The signwriting for 'sun' consists of a circle containing a horizontal line, followed by a hand with fingers spread and a horizontal line, and finally a hand with fingers spread.</p>
Sun	<p>The signwriting for 'Sun' consists of a vertical sequence of three hand shapes: a hand with fingers spread, a hand with fingers spread and a horizontal line, and a hand with fingers spread.</p>
Sunday	<p>The signwriting for 'Sunday' consists of two circles, each containing a horizontal line, positioned above two hand shapes with fingers spread.</p>

ASL Bible Dictionary

Spoken Word	SignWriting
Sunday	
sunrise	
sunrise	
sunset	
super	



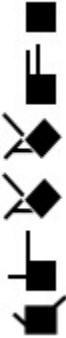

ASL Bible Dictionary

Spoken Word	SignWriting
Superbowl	
superior	
superior	
supervise	
supplication	
supply	
supply	

ASL Bible Dictionary

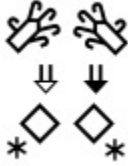
Spoken Word	SignWriting
supporter	<p>The signwriting for 'supporter' consists of three main components: a vertical stack of two squares at the top, a curved arrow pointing from the bottom square to the right, and two vertical bars below. Each vertical bar has a downward-pointing arrow at its base.</p>
supporters	<p>The signwriting for 'supporters' consists of three main components: a vertical stack of two squares at the top, a curved arrow pointing from the bottom square to the right, and two vertical bars below. Each vertical bar has a downward-pointing arrow at its base and a rightward-pointing arrow at its bottom end.</p>
supports	<p>The signwriting for 'supports' consists of a vertical stack of three squares, with two upward-pointing arrows at the bottom.</p>
supports	<p>The signwriting for 'supports' consists of a vertical stack of two squares, with a curved arrow pointing from the bottom square to the right.</p>
suppose	<p>The signwriting for 'suppose' consists of a central circle containing two upward-pointing arrows. To the left and right of the circle are two squares. Above the circle are two curved arrows pointing downwards.</p>
suppose	<p>The signwriting for 'suppose' consists of a circle with two diagonal lines inside, and a square to its right.</p>
suppress	<p>The signwriting for 'suppress' consists of a square with a downward-pointing arrow at its base, and a downward-pointing arrow below it.</p>

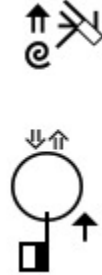
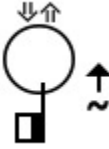





ASL Bible Dictionary

Spoken Word	SignWriting
suppress	
supreme	
sure	
surely	
surely	
surely	

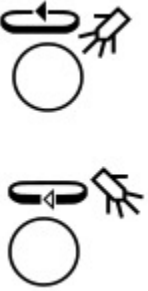



ASL Bible Dictionary

Spoken Word	SignWriting
surety	<p>The signwriting for 'surety' is a vertical sequence of seven symbols: a solid black square, a square with a horizontal line extending to the right, a square with a diagonal line from top-left to bottom-right, a square with a horizontal line extending to the right, a square with a horizontal line extending to the right, a square with a horizontal line extending to the right, and a square with a diagonal line from top-left to bottom-right.</p>
surface	<p>The signwriting for 'surface' consists of two symbols: a square with a diagonal line from top-left to bottom-right, and a square with a counter-clockwise circular arrow.</p>
surgeon	<p>The signwriting for 'surgeon' consists of three symbols: a square with a diagonal line from top-left to bottom-right and a downward-pointing arrow, a square with a vertical line and a downward-pointing arrow, and another square with a vertical line and a downward-pointing arrow.</p>
surgery	<p>The signwriting for 'surgery' consists of two symbols: a square with a diagonal line from top-left to bottom-right and a downward-pointing arrow, and a square with a vertical line and a downward-pointing arrow.</p>
surprise	<p>The signwriting for 'surprise' consists of three symbols: a square with a diagonal line from top-left to bottom-right and a small circle, a circle with three horizontal lines inside, and another square with a diagonal line from top-left to bottom-right and a small circle.</p>
surprise	<p>The signwriting for 'surprise' consists of three symbols: a square with a diagonal line from top-left to bottom-right and a small circle, a circle with three horizontal lines inside, and another square with a diagonal line from top-left to bottom-right and a small circle.</p>
surround	<p>The signwriting for 'surround' consists of three symbols: a square with a horizontal line and two arrows pointing right, a square with a diagonal line from top-left to bottom-right and a hand-like shape, and a square with a diagonal line from top-left to bottom-right.</p>
surround	<p>The signwriting for 'surround' consists of three symbols: a square with a horizontal line and two arrows pointing right, a square with a diagonal line from top-left to bottom-right and a hand-like shape, and a square with a diagonal line from top-left to bottom-right.</p>



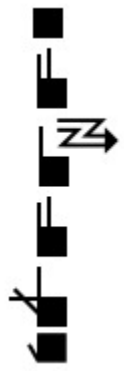



ASL Bible Dictionary

Spoken Word	SignWriting
surround	
surround	
Susa	
Susanna	
suspect	
suspend	

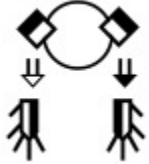

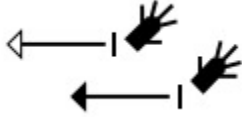



ASL Bible Dictionary

Spoken Word	SignWriting
Sutton	
Suzuka	
swallow	
swallow	
swallow-by-fish	

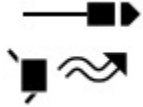





ASL Bible Dictionary

Spoken Word	SignWriting
swear	
sweat	
sweep	
sweep	
sweep	
sweet	
sweet-deer	
sweetheart	
swell-up	



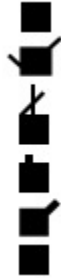

ASL Bible Dictionary

Spoken Word	SignWriting
swim	
swims	
sword	
sword	
swords	
sycamore	
Sychar	



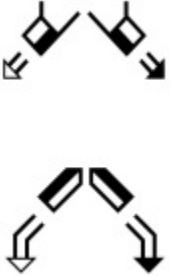



ASL Bible Dictionary

Spoken Word	SignWriting
Syria	
Syrian	
Syrtis	
system	
T	
Tabbaoth	



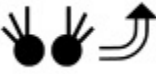



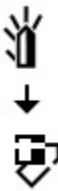

ASL Bible Dictionary

Spoken Word	SignWriting
tabernacle	
tabernacle	
Tabitha	
table	
tablets	

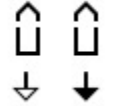
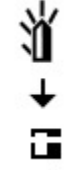

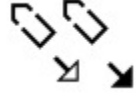
ASL Bible Dictionary

Spoken Word	SignWriting
tabret	
tail	
tail	
take	
take	
take	
take	

ASL Bible Dictionary

Spoken Word	SignWriting
take	
take	
take	
take	
take	
Take	
take	
take-advantage-of	
take-away	

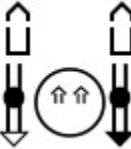

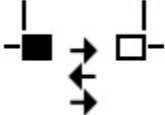
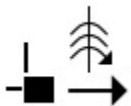
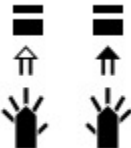

ASL Bible Dictionary

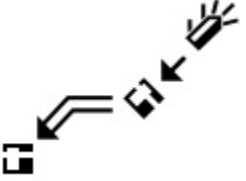
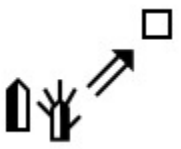
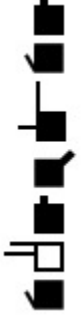
Spoken Word	SignWriting
take-away	
take-down	
take-off	
take-to-heart	
take-turns	
take-turns	
take-up	

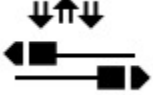
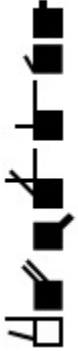
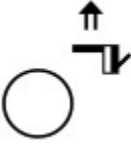

ASL Bible Dictionary

Spoken Word	SignWriting
take-up	
taken	
taken	
talitha	





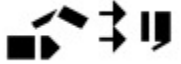

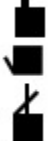
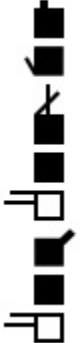
ASL Bible Dictionary

Spoken Word	SignWriting
talk	
talk	
talk	
talk-talk	
talking	
tall	
Talmon	







ASL Bible Dictionary

Spoken Word	SignWriting
Tamar	
tame	
tan	
tanner	
tar	
Tarshish	

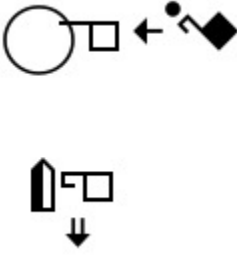

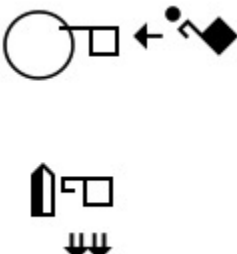

ASL Bible Dictionary

Spoken Word	SignWriting
Tarshish	
Tarsus	
tassels	
tassels	
taste	
taste	

ASL Bible Dictionary

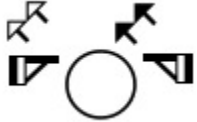
Spoken Word	SignWriting
taverns	
tax	
tax	
tax	
taxes	
taxes	
teach	

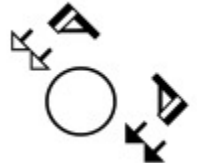

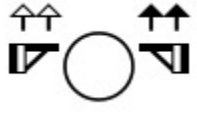
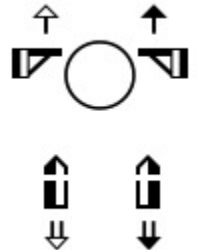
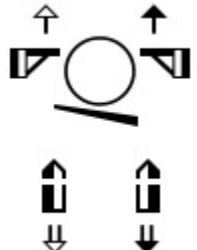

ASL Bible Dictionary

Spoken Word	SignWriting
teach	
teach	
teach	
teach	
teach	
teach	
teacher	
teacher	



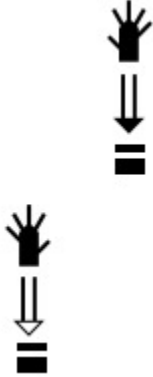
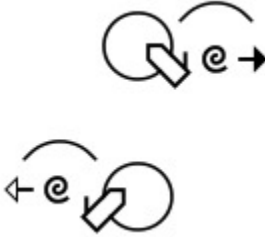

ASL Bible Dictionary

Spoken Word	SignWriting
teachers	<p>The signwriting for 'teachers' consists of two parts. The first part shows a circle with two upward-pointing arrows above it, and two trapezoidal shapes on either side of the circle, each with an upward-pointing arrow above it. The second part shows two vertical rectangular shapes, each with an upward-pointing arrow above it and a rightward-pointing arrow below it.</p>
team	<p>The signwriting for 'team' shows two trapezoidal shapes with upward-pointing arrows above them, positioned above two solid black squares.</p>
teams	<p>The signwriting for 'teams' shows two trapezoidal shapes with upward-pointing arrows above them, positioned above two solid black squares. To the right of the squares is a rightward-pointing arrow, followed by two more trapezoidal shapes with upward-pointing arrows above them.</p>
tear	<p>The signwriting for 'tear' shows a leftward-pointing arrow with a tilde (~) above it, followed by two diamond shapes, and then a rightward-pointing arrow with a tilde (~) above it.</p>
tear	<p>The signwriting for 'tear' shows a diamond shape with a hook on its left side, a circle with two upward-pointing arrows inside it, and another diamond shape with a hook on its right side. Arrows point from the diamond shapes towards the central circle.</p>
tear	<p>The signwriting for 'tear' shows a circle with wavy lines inside, representing a tear, and a diamond shape to its right. Below these is a downward-pointing arrow with a tilde (~) above it.</p>
tear-apart	<p>The signwriting for 'tear-apart' shows a circle with wavy lines inside, a diamond shape to its right, and two solid black squares below. Arrows point from the diamond and squares towards the circle.</p>
tears	<p>The signwriting for 'tears' shows a circle with wavy lines inside, a diamond shape to its right, and a downward-pointing arrow with a tilde (~) above it.</p>

ASL Bible Dictionary

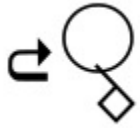
Spoken Word	SignWriting
tears down	
tears-dry	
Tebah	
Tebeth	
technical	
teeth	

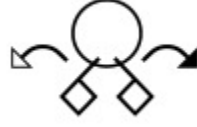
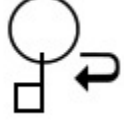
ASL Bible Dictionary

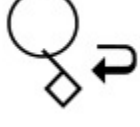
Spoken Word	SignWriting
telescope	
tell	
tell	
tell	
tell	
tell	
tell	
tell	
tell	





ASL Bible Dictionary

Spoken Word	SignWriting
tell	<p>The signwriting for 'tell' consists of a circle with a line extending from its bottom center to a diamond. An arrow points from the circle to the diamond, and another arrow points from the diamond back to the circle.</p>
tell-all	<p>The signwriting for 'tell-all' consists of a circle with a line extending from its bottom center to two diamonds. Arrows point from the circle to each diamond, and from each diamond back to the circle.</p>
tell-all	<p>The signwriting for 'tell-all' consists of a circle with a diagonal slash through it, a line extending from its bottom center to two diamonds, and arrows pointing from the circle to each diamond and back.</p>
tell-all	<p>The signwriting for 'tell-all' consists of a circle with a diagonal slash through it, a line extending from its bottom center to two diamonds, and arrows pointing from the circle to each diamond and back.</p>
tell-all	<p>The signwriting for 'tell-all' consists of a circle with a diagonal slash through it, a line extending from its bottom center to two diamonds, arrows pointing from the circle to each diamond and back, and a downward-pointing arrow above the circle.</p>
tell-me	<p>The signwriting for 'tell-me' consists of a circle with a diagonal slash through it, a line extending from its bottom center to a square, a downward-pointing arrow below the square, another square below that, and two asterisks (**).</p>
tell-me	<p>The signwriting for 'tell-me' consists of a circle with a diagonal slash through it, a line extending from its bottom center to a square, a downward-pointing arrow below the square, a diamond below that, and an asterisk (*) below the diamond.</p>

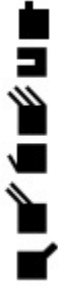
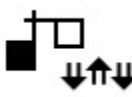

ASL Bible Dictionary

Spoken Word	SignWriting
tell-me	<p>The signwriting for 'tell-me' consists of a circle with two upward-pointing arrows above it, a vertical line extending downwards from the circle, a square, a horizontal line with an arrow pointing right, and a diamond with an arrow pointing down and to the left, followed by an asterisk.</p>
tell-self	<p>The signwriting for 'tell-self' consists of a circle, a vertical line extending downwards from the circle, a square, a horizontal line with an arrow pointing right, a diamond with an arrow pointing down and to the left, and two asterisks.</p>
tell-them	<p>The signwriting for 'tell-them' consists of a circle with a curved arrow pointing left, a vertical line extending downwards from the circle, and a diamond with an arrow pointing down and to the left.</p>
tell-us	<p>The signwriting for 'tell-us' consists of a circle with a vertical line extending downwards from the circle, a square, a horizontal line with an arrow pointing right, a diamond with an arrow pointing down and to the left, and two asterisks.</p>
telling	<p>The signwriting for 'telling' consists of a circle with a vertical line extending downwards from the circle, a square, a horizontal line with an arrow pointing right, and two diamonds with arrows pointing down and to the left.</p>
telling	<p>The signwriting for 'telling' consists of a circle with a vertical line extending downwards from the circle, a square, a horizontal line with an arrow pointing right, and two diamonds with arrows pointing down and to the left.</p>
telling	<p>The signwriting for 'telling' consists of a circle with a vertical line extending downwards from the circle, a square, a horizontal line with an arrow pointing right, and two diamonds with arrows pointing down and to the left.</p>





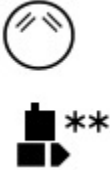
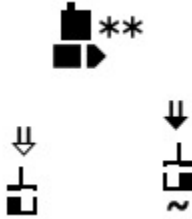
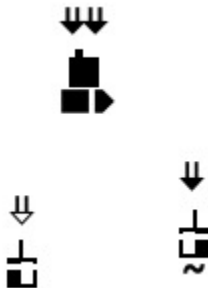
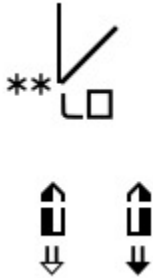

ASL Bible Dictionary

Spoken Word	SignWriting
Tema	
Temah	
Teman	
Temani	
temp	
temper	
Temple	



ASL Bible Dictionary

Spoken Word	SignWriting
Temple	
temples	
temples	
tempter	
Ten	
tendu	

ASL Bible Dictionary

Spoken Word	SignWriting
tent	
tenth	
tents	
Terah	
terebinth	
Teresh	



ASL Bible Dictionary

Spoken Word	SignWriting
terrified	
terrified	
terrified	





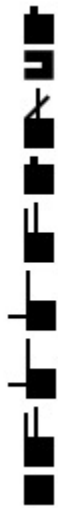
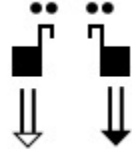
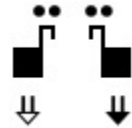

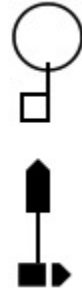
ASL Bible Dictionary

Spoken Word	SignWriting
territory	<p>The SignWriting for 'territory' consists of a vertical sequence of signs: a square with a horizontal line, a square with a diagonal line, a square with a diagonal line, a square with a diagonal line, a square with a diagonal line, a circle, a square with a diagonal line, and a square with a diagonal line.</p>
terror	<p>The SignWriting for 'terror' consists of a vertical sequence of signs: a square with a horizontal line, a square with a diagonal line, a square with a diagonal line, a square with a diagonal line, a circle, and a square with a diagonal line.</p>
Tertius	<p>The SignWriting for 'Tertius' consists of a vertical sequence of signs: a square with a horizontal line, a square with a diagonal line, a square with a diagonal line, a square with a diagonal line, a square with a diagonal line, a square with a horizontal line, and a square with a horizontal line.</p>

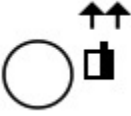







ASL Bible Dictionary

Spoken Word	SignWriting
Tertullus	
test	
test	
test	
test1	
testament	
testify	

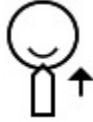



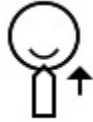

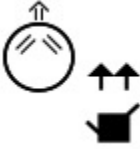
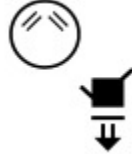

ASL Bible Dictionary

Spoken Word	SignWriting
testimony	
testimony	
text	
Thaddaeus	
Thahash	
than	
thank	





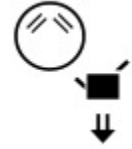



ASL Bible Dictionary

Spoken Word	SignWriting
thank	
thank	
thank	
Thank You	
Thank You God	
thank You God	
thanks	
thanks	
thanks	
that	

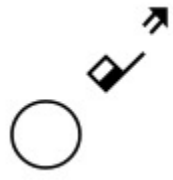





ASL Bible Dictionary

Spoken Word	SignWriting
that	
that	
that	
that	
that	
that	
that	
that	
that	



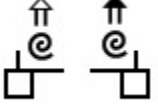
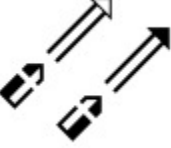



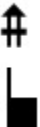

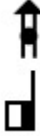

ASL Bible Dictionary

Spoken Word	SignWriting
that	
the	
the	
the	
the	
the	
the	
the	







ASL Bible Dictionary

Spoken Word	SignWriting
the	
the	
The	
The-Life	
The-Way	
theatre	
Thebes	
thee	
thee	

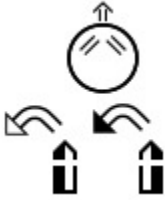



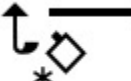

ASL Bible Dictionary

Spoken Word	SignWriting
thee	
thee	
thee	
their	
their	
their	
their	
them	
them	
them	
them	

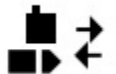
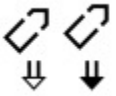



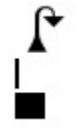









ASL Bible Dictionary

Spoken Word	SignWriting
then	
then	
then	
then	
then	
then	
then	
theology	

ASL Bible Dictionary

Spoken Word	SignWriting
Theophilus	
therapy	
there	
there	
there	
there	
there	
there	
there	



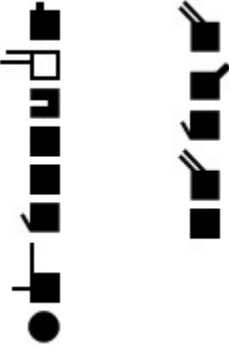

ASL Bible Dictionary

Spoken Word	SignWriting
there	
there	
there	
there	
there	
therefore	
thereof	  
these	 
these	  



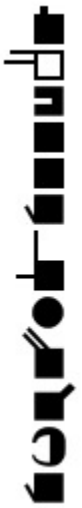
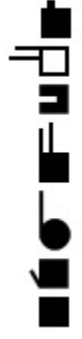

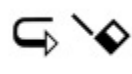

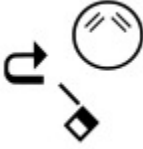

ASL Bible Dictionary

Spoken Word	SignWriting
Thessalonians	 The SignWriting for 'Thessalonians' consists of two vertical columns of symbols. The left column contains ten symbols: a square with a horizontal line extending to the left, a square with a horizontal line extending to the right, a square with a horizontal line extending to the right, a square with a horizontal line extending to the right, a square with a horizontal line extending to the right, a square with a horizontal line extending to the right, a square with a horizontal line extending to the right, a square with a horizontal line extending to the right, a square with a horizontal line extending to the right, and a solid black circle at the bottom. The right column contains five symbols: a square with a diagonal line extending from the top-left to the bottom-right, a square with a diagonal line extending from the top-left to the bottom-right, a square with a diagonal line extending from the top-left to the bottom-right, a square with a diagonal line extending from the top-left to the bottom-right, and a square with a diagonal line extending from the top-left to the bottom-right.





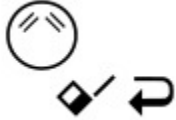



ASL Bible Dictionary

Spoken Word	SignWriting
Thessalonica	
Theudas	
they	
they	
they	
they	



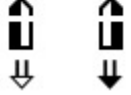

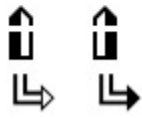



ASL Bible Dictionary

Spoken Word	SignWriting
they	
they	
they	
they	
they	
they	
they	
they	
they	

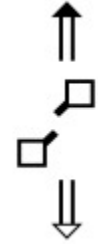





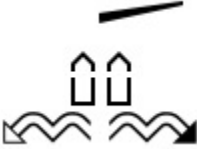

ASL Bible Dictionary

Spoken Word	SignWriting
they	
they	
thick	
thick	
thief	 
thieves	 
thigh	 





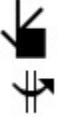
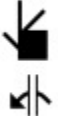

ASL Bible Dictionary

Spoken Word	SignWriting
thigh	
thighs	
thin	
thine	
thine	
thine	
thing	
thing	
things	

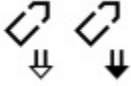
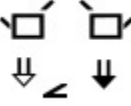



ASL Bible Dictionary

Spoken Word	SignWriting
things	
things	
think	
think	
think	
think	
think-same	
third	
third	
third	



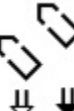

ASL Bible Dictionary

Spoken Word	SignWriting
thirsty	
this	
this	
this	
this	
this	
this	
this	



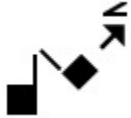
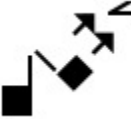
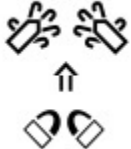

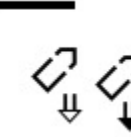

ASL Bible Dictionary

Spoken Word	SignWriting
this	 <p>The signwriting consists of a circle with two curved lines inside, representing the mouth. Below it is a square with a horizontal line extending to the right, and two arrows pointing downwards from the bottom of the square.</p>
this	 <p>The signwriting consists of a circle with two curved lines inside, representing the mouth. A diagonal line with a slash through it points from the top-left towards the bottom-right. Below it is a square with a horizontal line extending to the right, and two arrows pointing downwards from the bottom of the square.</p>
this	 <p>The signwriting consists of a circle with two curved lines inside, representing the mouth. A diagonal line with a slash through it points from the top-left towards the bottom-right. Below it is a square with a horizontal line extending to the right, and two arrows pointing downwards from the bottom of the square.</p>
this	 <p>The signwriting consists of two squares, one above the other, with a horizontal line extending to the right from the top square. Below each square are two arrows pointing downwards.</p>
this-Book	 <p>The signwriting consists of a circle with two curved lines inside, representing the mouth. To its right is a square with a horizontal line extending to the right, and two arrows pointing downwards from the bottom of the square. A diagonal arrow points from the top-right towards the bottom-left.</p>
thistles	 <p>The signwriting consists of a square with a horizontal line extending to the right, and two arrows pointing downwards from the bottom of the square. Below this is a vertical line of seven small squares, with a horizontal line extending to the right from the bottom square.</p>

ASL Bible Dictionary

Spoken Word	SignWriting
Thomas	
thorn	
thorns	
thorns	
thorns	
thorns	
those	
those-two	

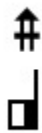

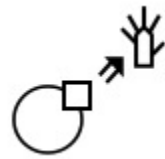
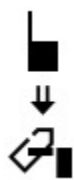

ASL Bible Dictionary

Spoken Word	SignWriting
those-two	
Thou	
thou	
thou	
thou	
Thou	
though	
thought	
thought	
thousand	





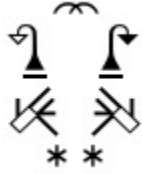
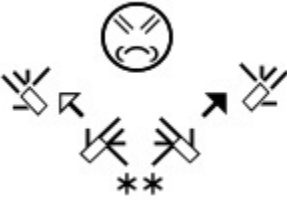
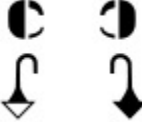



ASL Bible Dictionary

Spoken Word	SignWriting
thousand	<p>The sign for 'thousand' is represented by a downward arrow pointing to a hand icon, which is then followed by a solid black square.</p>
thread	<p>The sign for 'thread' is represented by a circle containing the number '10' with two upward arrows above it. Below this are two upward arrows, followed by a hand icon with a diamond shape, and finally a hand icon with a square shape.</p>
threat	<p>The sign for 'threat' is represented by a hand icon with a square shape, followed by a hand icon with a square shape and a rightward arrow.</p>
Three	<p>The sign for 'Three' is represented by a hand icon with a square shape and a downward arrow.</p>
three	<p>The sign for 'three' is represented by a hand icon with a square shape and a downward arrow.</p>
Three-In-One	<p>The sign for 'Three-In-One' is represented by a hand icon with a square shape and a downward arrow, followed by a hand icon with a square shape and a downward arrow, and finally a hand icon with a square shape and a downward arrow.</p>
thresh	<p>The sign for 'thresh' is represented by a hand icon with a square shape and a downward arrow, followed by a hand icon with a square shape and a downward arrow, and finally a hand icon with a square shape and a downward arrow.</p>



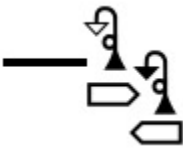

ASL Bible Dictionary

Spoken Word	SignWriting
thresh	
thrice	
thrill	
thrill	
thrill	
throne	
throne	





ASL Bible Dictionary

Spoken Word	SignWriting
through	
through	
through	
through	
through	
through	
throughout	
throughout	
throw	



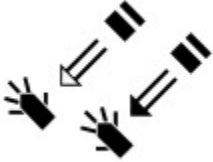

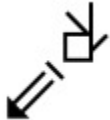

ASL Bible Dictionary

Spoken Word	SignWriting
throw	
throw	
throw	
throw	

ASL Bible Dictionary

Spoken Word	SignWriting
throw	
throw	
throw	
throw	
throw-ashes	
throw-away	

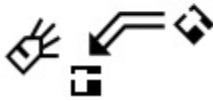

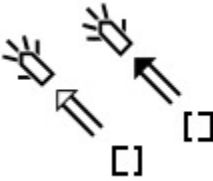
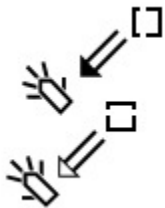



ASL Bible Dictionary

Spoken Word	SignWriting
throw-away	
throw-dust	 
throw-in-jail	 
throw-into	
throw-out	
throw-out	

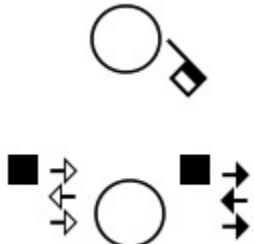
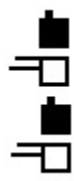





ASL Bible Dictionary

Spoken Word	SignWriting
throw-rocks	<p>The SignWriting for 'throw-rocks' consists of a central circle containing a horizontal line with a small vertical tick on the left side. Above this circle are two sets of two upward-pointing arrows. To the left and right of the central circle are two hand icons, each with two upward-pointing arrows. Above each hand icon is a symbol consisting of three diagonal lines and a hash symbol (#).</p>
throw-stones	<p>The SignWriting for 'throw-stones' features a central circle. Above it is a symbol of three diagonal lines and a hash symbol (#). To the left and right of the circle are two hand icons, each with two arrows pointing away from the hand, indicating a throwing motion.</p>
thread	<p>The SignWriting for 'thread' is a vertical sequence of symbols. From top to bottom: a square with a horizontal line extending to the left; a hand icon with a vertical line extending upwards; a square with a horizontal line extending to the right; a square with a horizontal line extending to the left; and a solid black circle at the bottom.</p>
thru	<p>The SignWriting for 'thru' shows a hand icon with an arrow pointing to the left. Above the hand is a circle containing two horizontal lines.</p>
thru	<p>The SignWriting for 'thru' depicts a hand icon with an arrow pointing upwards and to the right.</p>



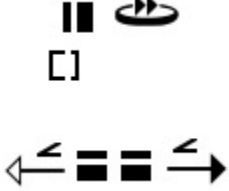

ASL Bible Dictionary

Spoken Word	SignWriting
Thummim	
thunder	
Thursday	
Thy	
thy	
thy	
thy	
Thy	

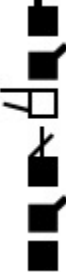
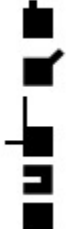

ASL Bible Dictionary

Spoken Word	SignWriting
Tiberius	
ticket	
Tidal	
tie	
tie	
tie	
tie-neck	





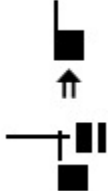
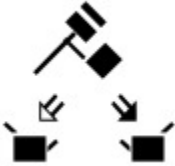
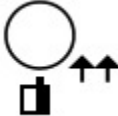
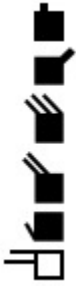
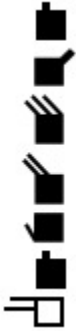

ASL Bible Dictionary

Spoken Word	SignWriting
tie-up	
tiger	
Tigris	
tiles	
tim	
Timaeus	







ASL Bible Dictionary

Spoken Word	SignWriting
time	
time	
time one	
time same	
Timnah	
Timnah	
Timnath	

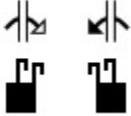

ASL Bible Dictionary

Spoken Word	SignWriting
Timon	
timothy	
tiny	
tip	
tip	
tips	
Tiras	





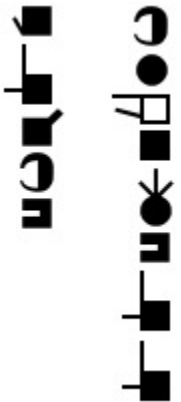
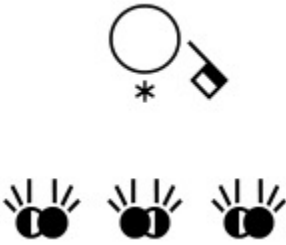

ASL Bible Dictionary

Spoken Word	SignWriting
tired	
tired	
tithe	
tithes	
Titius	
title	
title	

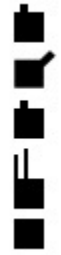



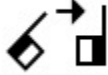

ASL Bible Dictionary

Spoken Word	SignWriting
TITLEAliceCogswell	 <p>The SignWriting for 'AliceCogswell' consists of two vertical columns of symbols. The left column contains the letters 'A', 'L', 'I', 'C', 'E' from top to bottom. The right column contains the letters 'C', 'O', 'G', 'S', 'W', 'E', 'L', 'L' from top to bottom.</p>
TITLEDeaflympics	 <p>The SignWriting for 'Deaflympics' features a central symbol of a circle with a star below it, and a small square to its right. Below this are three identical symbols of a hand with fingers spread, representing the sign for 'Deaf'.</p>
TITLEDiabetes	 <p>The SignWriting for 'Diabetes' consists of a circle with a vertical line through its center, and a hand with fingers spread below it.</p>
TitleJohn	 <p>The SignWriting for 'John' consists of a hand with fingers spread, a circle, and a hand with fingers spread below it.</p>



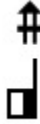



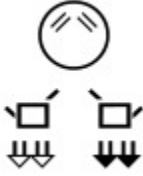

ASL Bible Dictionary

Spoken Word	SignWriting
TITLE Linda Bove	
Titus	
TJ	
to	
to	
to	
to	

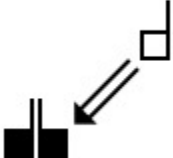





ASL Bible Dictionary

Spoken Word	SignWriting
to	
to	
to	
to	
tobacco	
Tobiah	
today	
today	



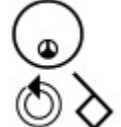

ASL Bible Dictionary

Spoken Word	SignWriting
Togarmah	
together	
together	
together	
together	
together	
together	
together	
together	





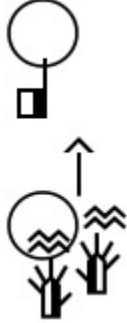

ASL Bible Dictionary

Spoken Word	SignWriting
together	
Tola	
Tom	
tomb	
tomorrow	
tomorrow	
tongue	

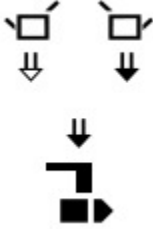
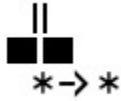
ASL Bible Dictionary

Spoken Word	SignWriting
tongue	
tongue-fire	
tongues	
tongues	
tongues	



ASL Bible Dictionary

Spoken Word	SignWriting
tonight	
too	
took	
took	
tools	
tooth	
top	

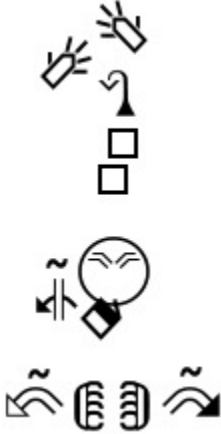

ASL Bible Dictionary

Spoken Word	SignWriting
topaz	<p>The SignWriting for 'topaz' consists of a vertical sequence of symbols: a square, a circle, a diamond with a diagonal slash, a square, and a square with a zigzag arrow pointing to the right.</p>
topic	<p>The SignWriting for 'topic' is a circle with two short horizontal lines inside, resembling a pair of eyes.</p>
torch	<p>The SignWriting for 'torch' consists of a vertical sequence of symbols: an upward-pointing arrow, a square, another square, a wavy line, a hand holding a flame, and a square.</p>
torch	<p>The SignWriting for 'torch' consists of a vertical sequence of symbols: a square, a circle, a diamond with a diagonal slash, a square, a circle, and a square.</p>
torches	<p>The SignWriting for 'torches' consists of a vertical sequence of symbols: a square, a circle, a diamond with a diagonal slash, a square, a circle, a square, and a square.</p>

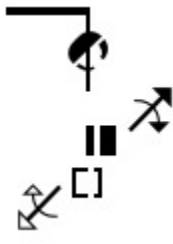



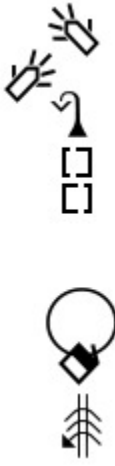

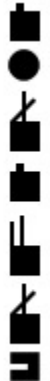

ASL Bible Dictionary

Spoken Word	SignWriting
torment	 <p>A vertical sequence of seven black icons: a square, a circle, a hand with fingers spread, a hand with fingers spread, a hand with fingers spread, a hand with fingers spread, and a square.</p>
torment	 <p>A vertical sequence of seven icons: a hand with fingers spread, a hand with fingers spread, a hand with fingers spread, a square, a square, a face with a sad expression, and a hand with fingers spread.</p>
torn	 <p>A vertical sequence of five icons: a hand with fingers spread, a hand with fingers spread, a square, a square, and a hand with fingers spread.</p>
torn	 <p>A vertical sequence of five icons: a hand with fingers spread, a hand with fingers spread, a square, a square, and a hand with fingers spread.</p>

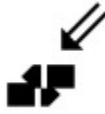
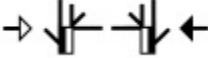
ASL Bible Dictionary

Spoken Word	SignWriting
Toronto	
torture	
torture	
torture	



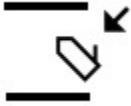





ASL Bible Dictionary

Spoken Word	SignWriting
toss	
touch	
touch	
touch	
touch	
touch	
touch	
touch-scar	
touch-scars	
touch-wound	





ASL Bible Dictionary

Spoken Word	SignWriting
tourist	<p>The signwriting for 'tourist' consists of a wavy line starting from the top left, curving down and then up to the right, ending in a small square. Below this are two vertical arrows pointing up and down, one on the left and one on the right.</p>
tow	<p>The signwriting for 'tow' features a wavy line starting from the top left, curving down and then up to the right, ending in a small square. To the right of the square is a vertical line with an asterisk at the top. Below the square is a downward-pointing arrow.</p>
towel	<p>The signwriting for 'towel' includes a circle with a vertical line through its center. Below the circle are two small squares. To the left of the squares are two arrows pointing up and down. To the right of the squares are two arrows pointing left and right.</p>
tower	<p>The signwriting for 'tower' is composed of two diamond shapes at the top, each with a vertical line through its center. Below these are three upward-pointing arrows. At the bottom are two vertical arrows pointing up and down, one on the left and one on the right.</p>
Tower	<p>The signwriting for 'Tower' is a vertical sequence of symbols: a small square at the top, followed by a solid circle, then a circle with a vertical line through its center, then a solid square, and finally a solid square with a vertical line through its center at the bottom.</p>





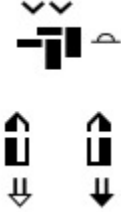

ASL Bible Dictionary

Spoken Word	SignWriting
town	
town	
town	
town	
towns	
towns	
Towns	
track	





ASL Bible Dictionary

Spoken Word	SignWriting
Traconitis	
trade	
traders	
training	
training	
traitor	



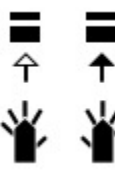

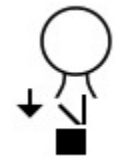
ASL Bible Dictionary

Spoken Word	SignWriting
trample	
trample	
trance	
transfer	
translate	
translate	



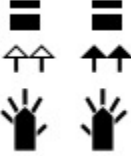

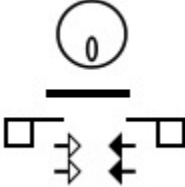
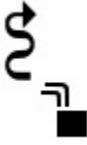
ASL Bible Dictionary

Spoken Word	SignWriting
translator	
trap	
trap	
trap	
trap	
trapper	





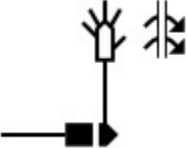

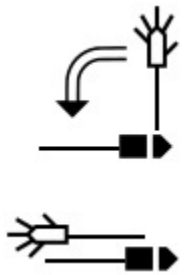
ASL Bible Dictionary

Spoken Word	SignWriting
traps	
traps	
travail	
travel	
tray	
treacherous	

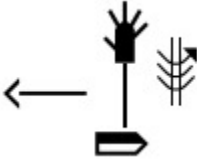
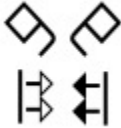

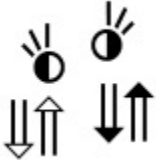



ASL Bible Dictionary

Spoken Word	SignWriting
Treasury	
treat	
tree	
tree	
tree	
tree-chop	

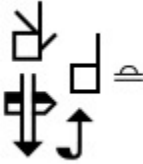



ASL Bible Dictionary

Spoken Word	SignWriting
trees	
tremble	
trembled	
trial	
tribes	
tribute	
trick	





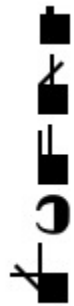

ASL Bible Dictionary

Spoken Word	SignWriting
Trinity	
Trinity	
trip	
Troas	
Trophimus	
trophy	

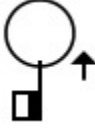



ASL Bible Dictionary

Spoken Word	SignWriting
trouble	
trouble	
trouble	
trough	
truck	



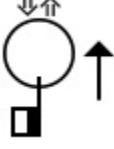

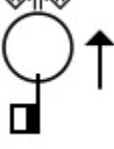
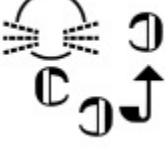

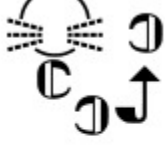
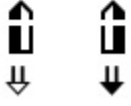
ASL Bible Dictionary

Spoken Word	SignWriting
true	
true	
true	
true	
true	
true	
True	

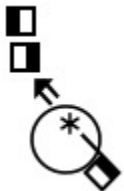





ASL Bible Dictionary

Spoken Word	SignWriting
truly	
truly	
truly	
truly	
trumpet	
trumpet	
trumpeter	 

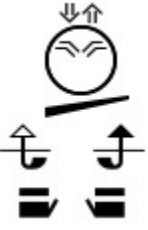

ASL Bible Dictionary

Spoken Word	SignWriting
trust	
trust	
trust	
trust	
trust	
truth	
truth	

ASL Bible Dictionary

Spoken Word	SignWriting
truth	
truth	
try	
try	
try	
trying	

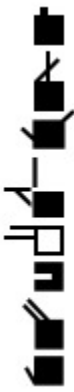

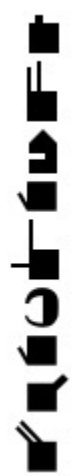

ASL Bible Dictionary

Spoken Word	SignWriting
Tryphena	
Tryphosa	
Tubal	
Tubalcain	



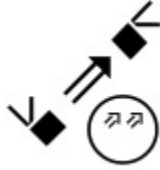

ASL Bible Dictionary

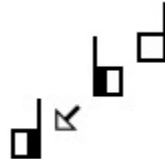
Spoken Word	SignWriting
tuna	<p>The signwriting for 'tuna' consists of a vertical sequence of five symbols: a square with a horizontal line, a square with a horizontal line, a square with a diagonal line, a square with a diagonal line, and a square with a diagonal line.</p>
tunic	<p>The signwriting for 'tunic' consists of a vertical sequence of six symbols: a square with a horizontal line, a square with a horizontal line, a square with a diagonal line, a square with a diagonal line, a square with a diagonal line, and a square with a diagonal line.</p>
turban	<p>The signwriting for 'turban' consists of a central circle with two hands positioned above it, one on the left and one on the right, with fingers spread.</p>
turkey	<p>The signwriting for 'turkey' consists of a circle with a hand positioned above it, with fingers spread, and two asterisks below it.</p>
turn	<p>The signwriting for 'turn' consists of two circular symbols. The top symbol has a hand with fingers spread above it, and the bottom symbol has a hand with fingers spread to the right of it.</p>
turn	<p>The signwriting for 'turn' consists of a square with a horizontal line, a square with a horizontal line, and a square with a horizontal line.</p>
turn	<p>The signwriting for 'turn' consists of a circle with a hand positioned above it, with fingers spread, and a horizontal line below it.</p>



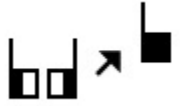
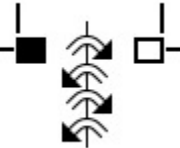
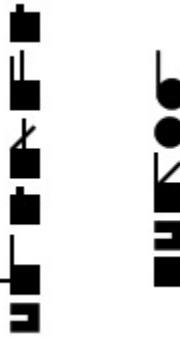



ASL Bible Dictionary

Spoken Word	SignWriting
turn	
turn	
turn	
turn	
turn back	
turn-away	

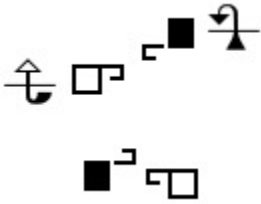
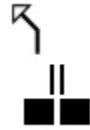

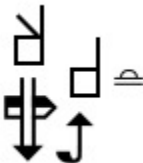

ASL Bible Dictionary

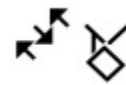
Spoken Word	SignWriting
turn-away	
turn-away	
turns	
turtledoves	
TV	
twelve	
twins	
twins	





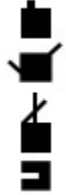

ASL Bible Dictionary

Spoken Word	SignWriting
twist	
twisted	
twisted	
two	
two-become-one	
two-of-them	
two-of-them	
two-of-them	
two-of-them	

ASL Bible Dictionary

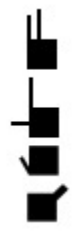
Spoken Word	SignWriting
Tyndale	
typhoon	
Tyrannus	
Tyre	
U	







ASL Bible Dictionary

Spoken Word	SignWriting
UCSD	
UK	
Ulai	
UN	
unanimous	
unaware	



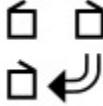
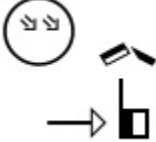
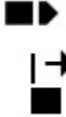





ASL Bible Dictionary

Spoken Word	SignWriting
unbelief	<p>The sign for 'unbelief' is composed of three parts: a circle with a small square below it and an arrow pointing up and to the right; a circle with a small square to its right and an arrow pointing down and to the right; and a square with a small circle to its left and an arrow pointing down and to the right.</p>
unbeliever	<p>The sign for 'unbeliever' is composed of four parts: a circle with a small square below it and an arrow pointing up and to the right; a circle with a small square to its right and an arrow pointing down and to the right; a square with a small circle to its left and an arrow pointing down and to the right; and two separate signs, each consisting of a small square with an arrow pointing up and down.</p>
unbelievers	<p>The sign for 'unbelievers' is composed of four parts: a circle with a small square below it and an arrow pointing up and to the right; a circle with a small square to its right and an arrow pointing down and to the right; a square with a small circle to its left and an arrow pointing down and to the right; and two separate signs, each consisting of a small square with an arrow pointing up and down, and a small square with an arrow pointing right.</p>
uncle	<p>The sign for 'uncle' is composed of two parts: a circle with a small square to its right and an arrow pointing up and to the right; and a square with a small circle to its left and an arrow pointing up and to the right.</p>

ASL Bible Dictionary

Spoken Word	SignWriting
unclean	
under	
under	
under-wing	
underscore	
understand	
understand	
understand	



ASL Bible Dictionary

Spoken Word	SignWriting
understand	
understand	
understand	
understand	
understanding	
unfailing	
unfair	
unicorn	



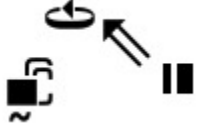
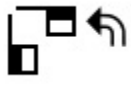
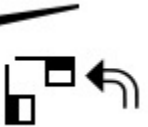
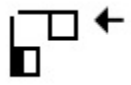

ASL Bible Dictionary

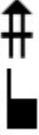
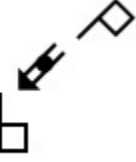
Spoken Word	SignWriting
unjust	<p>The signwriting for 'unjust' consists of three parts: a circle with a hand icon and an arrow pointing clockwise, a small square with a vertical line, and two L-shaped brackets.</p>
unrighteous	<p>The signwriting for 'unrighteous' consists of two parts: a circle with a hand icon and an arrow pointing clockwise, and a more complex structure of squares and lines with a hand icon and a circular arrow.</p>
unrighteous	<p>The signwriting for 'unrighteous' consists of a circle with a hand icon and a small square.</p>
unrighteousness	<p>The signwriting for 'unrighteousness' consists of a circle with a hand icon and a small square.</p>
unstable	<p>The signwriting for 'unstable' consists of two parts: a hand icon with an arrow pointing up, and a hand icon with an arrow pointing down.</p>
untie	<p>The signwriting for 'untie' consists of two hand icons with arrows pointing away from each other, and two vertical double-headed arrows.</p>
untie	<p>The signwriting for 'untie' consists of a hand icon with an arrow pointing right, and a hand icon with an arrow pointing down.</p>



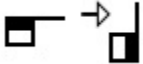
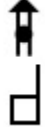
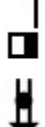

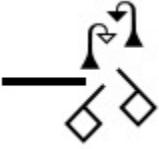
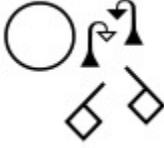

ASL Bible Dictionary

Spoken Word	SignWriting
untie	
untie	
until	
until	
unto	
unto	
unto	
unto	
unto	



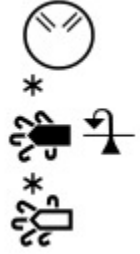
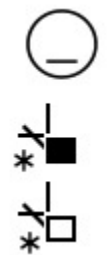

ASL Bible Dictionary

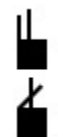
Spoken Word	SignWriting
unto	
unto	
unto	
unwrap	
up	
up	
up-to	
up-to-now	
up-to-now	





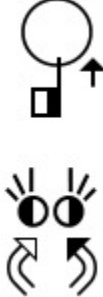

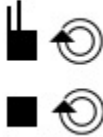

ASL Bible Dictionary

Spoken Word	SignWriting
up-to-you	
upright	
upset	
upset	
upset	
upstairs	
upstairs	
Ur	





ASL Bible Dictionary

Spoken Word	SignWriting
Urbanus	
urgent	
urgent	
Uriah	
Urim	





ASL Bible Dictionary

Spoken Word	SignWriting
US	
us	
use	
use	
USS	
Utah	
Utah	
Uz	
Uz	

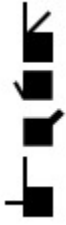

ASL Bible Dictionary

Spoken Word	SignWriting
Uzai	
Uzal	
Uzza	
Uzzah	
Uzziah	

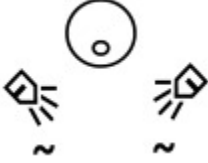
ASL Bible Dictionary

Spoken Word	SignWriting
Uzziel	
v	
VA	
VAIL	
vail	
vail	
vain	

ASL Bible Dictionary

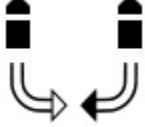
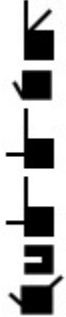
Spoken Word	SignWriting
Vaizatha	
Valerie	
Valerie	
valley	
Valley	





ASL Bible Dictionary

Spoken Word	SignWriting
van	
van-der	
vanilla	
various	
Vashti	
Vashti	
vats	



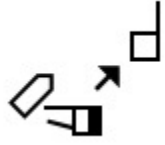
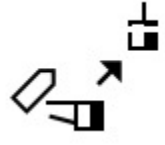
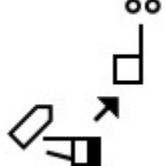
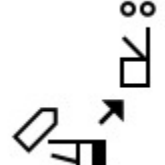
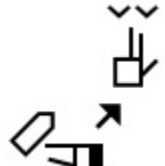

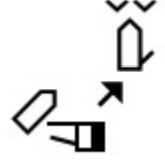
ASL Bible Dictionary

Spoken Word	SignWriting
veg	
vegetable	
vegetables	
vehicle	
veil	
Vera Thomas	
veres60	
verse	



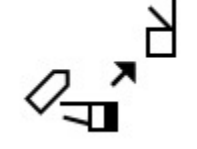

ASL Bible Dictionary

Spoken Word	SignWriting
verse1	
verse10	
verse11	
verse12	
verse13	
verse14	
verse15	
verse16	



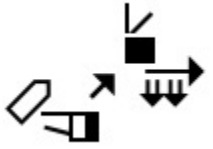
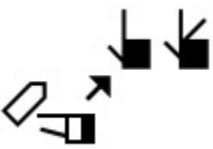
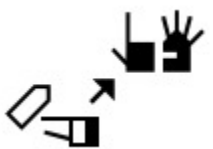



ASL Bible Dictionary

Spoken Word	SignWriting
verse17	
verse18	
verse19	
verse2	
verse20	

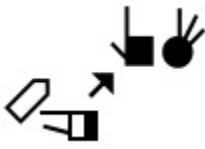
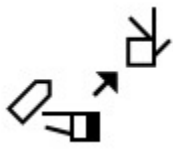



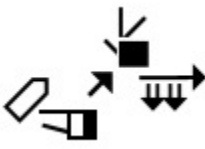

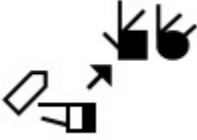

ASL Bible Dictionary

Spoken Word	SignWriting
verse21	
verse22	
verse23	
verse24	
verse25	
verse26	
verse27	
verse28	









ASL Bible Dictionary

Spoken Word	SignWriting
verse29	
verse3	
verse30	
verse31	
verse32	
verse33	
verse34	
verse35	









ASL Bible Dictionary

Spoken Word	SignWriting
verse36	
verse37	
verse38	
verse39	
verse4	
verse40	
verse41	
verse42	
verse43	









ASL Bible Dictionary

Spoken Word	SignWriting
verse44	
verse45	
verse46	
verse47	
verse48	
verse49	
verse5	
verse50	
verse51	







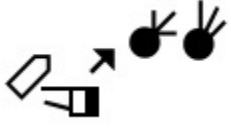

ASL Bible Dictionary

Spoken Word	SignWriting
verse52	
verse53	
verse54	
verse55	
verse56	
verse57	
verse58	
verse59	
verse6	

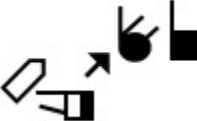
ASL Bible Dictionary

Spoken Word	SignWriting
verse60	
verse61	
verse62	
verse63	
verse64	
verse65	
verse66	
verse67	
verse68	

ASL Bible Dictionary

Spoken Word	SignWriting
verse69	
verse7	
verse70	
verse71	
verse72	
verse73	
verse8	
verse9	
verses	







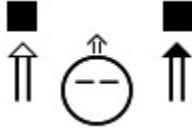

ASL Bible Dictionary

Spoken Word	SignWriting
very	<p>The SignWriting symbol for 'very' consists of a circle with a vertical line extending downwards from its center to a small square. To the right of the circle is an upward-pointing arrow.</p>
very	<p>The SignWriting symbol for 'very' consists of a circle with a horizontal line across its center. Below the circle is a bracket-like shape. Above the circle is an upward-pointing arrow.</p>
vet	<p>The SignWriting symbol for 'vet' is a vertical sequence of four distinct handshapes: a hand with fingers spread, a hand with fingers curled, a hand with fingers spread, and a hand with fingers curled.</p>
veterinarian	<p>The SignWriting symbol for 'veterinarian' is a vertical sequence of ten distinct handshapes, representing the sign for the word.</p>







ASL Bible Dictionary

Spoken Word	SignWriting
veterinary	<p>The sign for 'veterinary' is a vertical sequence of 11 signs. From top to bottom: a hand with index finger pointing up and thumb pointing right; a hand with index finger pointing up and thumb pointing left; a hand with index finger pointing up and thumb pointing right; a hand with index finger pointing up and thumb pointing left; a hand with index finger pointing up and thumb pointing right; a hand with index finger pointing up and thumb pointing left; a hand with index finger pointing up and thumb pointing right; a hand with index finger pointing up and thumb pointing left; a hand with index finger pointing up and thumb pointing right; a hand with index finger pointing up and thumb pointing left; a hand with index finger pointing up and thumb pointing right.</p>
vicious	<p>The sign for 'vicious' consists of two hand signs. The first sign is a hand with index finger pointing up and thumb pointing right. The second sign is a hand with index finger pointing up and thumb pointing left, with a downward-pointing arrow below it.</p>
victim	<p>The sign for 'victim' is a vertical sequence of 6 signs. From top to bottom: a hand with index finger pointing up and thumb pointing right; a hand with index finger pointing up and thumb pointing left; a hand with index finger pointing up and thumb pointing right; a hand with index finger pointing up and thumb pointing left; a hand with index finger pointing up and thumb pointing right; a hand with index finger pointing up and thumb pointing left.</p>
victorious	<p>The sign for 'victorious' consists of two pairs of hand signs. The first pair shows a hand with index finger pointing up and thumb pointing right, and a hand with index finger pointing up and thumb pointing left. The second pair shows a hand with index finger pointing up and thumb pointing right, and a hand with index finger pointing up and thumb pointing left.</p>
victory	<p>The sign for 'victory' consists of three hand signs. On the left, a hand with index finger pointing up and thumb pointing right. In the center, a circle. On the right, a hand with index finger pointing up and thumb pointing left.</p>
victory	<p>The sign for 'victory' consists of two pairs of hand signs. The first pair shows a hand with index finger pointing up and thumb pointing right, and a hand with index finger pointing up and thumb pointing left. The second pair shows a hand with index finger pointing up and thumb pointing right, and a hand with index finger pointing up and thumb pointing left.</p>





ASL Bible Dictionary

Spoken Word	SignWriting
victory	
video	
view	
view	
village	
village	
vine	
vine	



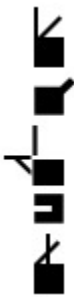

ASL Bible Dictionary

Spoken Word	SignWriting
vinegar	
vineyard	
Vineyard	
violence	
violent	 

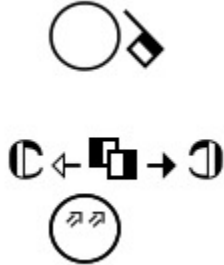
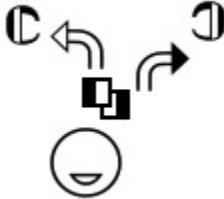
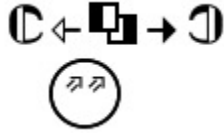

ASL Bible Dictionary

Spoken Word	SignWriting
viper	
virgin	
virgin	
Virginia	
Virginia	

ASL Bible Dictionary

Spoken Word	SignWriting
vision	 <p>The signwriting for 'vision' in this row consists of three elements: a circle with a hand icon pointing to the right, a central square with arrows pointing left and right, and a circle containing two small arrows pointing towards each other.</p>
vision	 <p>The signwriting for 'vision' in this row consists of three elements: a circle with a hand icon pointing left, a central square with arrows pointing left and right, and a circle with a hand icon pointing down.</p>
vision	 <p>The signwriting for 'vision' in this row consists of three elements: a circle with a hand icon pointing left, a central square with arrows pointing left and right, and a circle containing two small arrows pointing towards each other.</p>
visit	 <p>The signwriting for 'visit' in this row consists of two vertical elements: a square with a hand icon pointing down, and a hand icon with fingers spread.</p>
visitor	 <p>The signwriting for 'visitor' in this row consists of two vertical elements: a square with a hand icon pointing down, and a hand icon with fingers spread.</p>
visitors	 <p>The signwriting for 'visitors' in this row consists of two vertical elements: a square with a hand icon pointing down, and a hand icon with fingers spread. Below these are two more vertical elements: a square with a hand icon pointing down and a hand icon pointing right, and another square with a hand icon pointing down and a hand icon pointing right.</p>

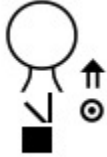
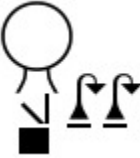



ASL Bible Dictionary

Spoken Word	SignWriting
voice	
voice	
voices	
voices	
void	



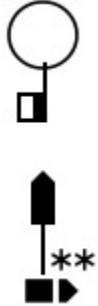
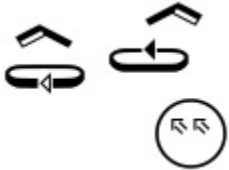



ASL Bible Dictionary

Spoken Word	SignWriting
volume	<p>The sign for 'volume' is written vertically. It starts with a hand sign for 'V' (index finger pointing up, thumb pointing left, other fingers curled). This is followed by a hand sign for 'L' (index finger pointing up, thumb pointing right, other fingers curled). The final part of the sign is a hand sign for 'E' (index finger pointing up, thumb pointing left, other fingers curled).</p>
volumes	<p>The sign for 'volumes' consists of two parts. The first part shows two vertical bars with small circles at the top, representing books. The second part shows three upward-pointing arrows, with a circle and a rightward-pointing arrow below them, indicating a sequence or list.</p>
volunteer	<p>The sign for 'volunteer' features a circle on the left. To its right are two upward-pointing arrows. Below the arrows is a hand sign for 'V' (index finger pointing up, thumb pointing left, other fingers curled), and a plus sign (+) is positioned at the bottom.</p>
vomit	<p>The sign for 'vomit' shows a hand sign for 'V' (index finger pointing up, thumb pointing left, other fingers curled) on the left. To its right is a hand sign for 'O' (index finger pointing up, thumb pointing right, other fingers curled) with a circle above it. Below these is a hand sign for 'M' (index finger pointing up, thumb pointing left, other fingers curled) with a hand sign for 'I' (index finger pointing up, thumb pointing right, other fingers curled) to its right.</p>
vomit	<p>The sign for 'vomit' features a hand sign for 'V' (index finger pointing up, thumb pointing left, other fingers curled) on the left. To its right is a hand sign for 'O' (index finger pointing up, thumb pointing right, other fingers curled) with a circle above it and an upward-pointing arrow to its right. Below these is a hand sign for 'M' (index finger pointing up, thumb pointing left, other fingers curled) with an upward-pointing arrow above it.</p>
vote	<p>The sign for 'vote' starts with a hand sign for 'V' (index finger pointing up, thumb pointing left, other fingers curled). This is followed by a hand sign for 'E' (index finger pointing up, thumb pointing left, other fingers curled). The final part of the sign is a hand sign for 'O' (index finger pointing up, thumb pointing right, other fingers curled) with a circle above it.</p>

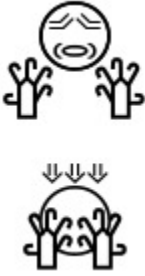
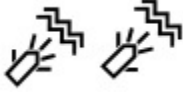







ASL Bible Dictionary

Spoken Word	SignWriting
VOWS	
vultures	
vultures	
W	
wagon	



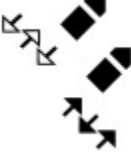

ASL Bible Dictionary

Spoken Word	SignWriting
wail	
wait	
wait	
wait	
wait	
wait	
wait	
waiting	



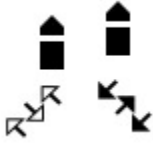
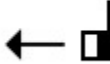

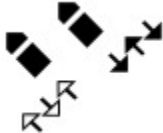
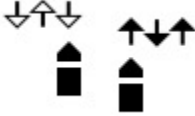
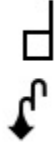

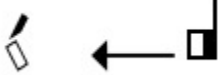
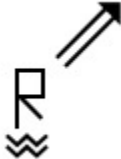

ASL Bible Dictionary

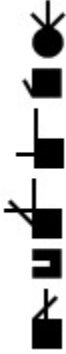
Spoken Word	SignWriting
wake-up	
wake-up	
wake-up	
walk	
walk	
walk	
walk	
walk	
walk	
walk	



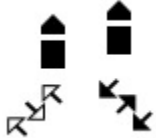



ASL Bible Dictionary

Spoken Word	SignWriting
walk	
walk	
walk	
walk	
walk	
walk	
walk	
walk-to-boat	
walk-up	

ASL Bible Dictionary

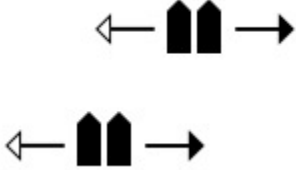
Spoken Word	SignWriting
Walker	
walking	
walking	
walking	
walking	
walking-to-boat	
Wall	
wall	

ASL Bible Dictionary

Spoken Word	SignWriting
Wallace	
wallet	
walls	
Walt	
wander	
wander	

ASL Bible Dictionary

Spoken Word	SignWriting
wander-off	<p>The signwriting consists of a black square on the left and a black square on the right. A line starts from the top of the right square, goes up, then left, then down, ending in an arrowhead pointing left.</p>
wander-off	<p>The signwriting consists of a black square on the left and a black square on the right. A line starts from the top of the right square, goes up, then left, then down, ending in an arrowhead pointing left. A curved arrow starts from the top of the right square, goes up, then left, then down, ending in an arrowhead pointing left.</p>
wanderer	<p>The signwriting consists of a black square on the left and a black square on the right. A line starts from the top of the right square, goes up, then left, then down, then up, then left, then down, ending in an arrowhead pointing left. Below the squares are two vertical lines, each with a double-headed arrow pointing up and down.</p>
wanderers	<p>The signwriting consists of a black square on the left and a black square on the right. A line starts from the top of the right square, goes up, then left, then down, then up, then left, then down, ending in an arrowhead pointing left. Below the squares are two vertical lines, each with a double-headed arrow pointing up and down. The right vertical line has a small arrow pointing right at the bottom.</p>
want	<p>The signwriting consists of two hands. The left hand is open, palm up, with fingers spread. The right hand is open, palm down, with fingers spread. A line starts from the top of the right hand, goes up, then left, then down, ending in an arrowhead pointing left.</p>
want	<p>The signwriting consists of two hands. The left hand is open, palm up, with fingers spread. The right hand is open, palm down, with fingers spread. A line starts from the top of the right hand, goes up, then left, then down, ending in an arrowhead pointing left.</p>
wanted	<p>The signwriting consists of two hands. The left hand is open, palm up, with fingers spread. The right hand is open, palm down, with fingers spread. A line starts from the top of the right hand, goes up, then left, then down, ending in an arrowhead pointing left.</p>
wants	<p>The signwriting consists of two hands. The left hand is open, palm up, with fingers spread. The right hand is open, palm down, with fingers spread. A line starts from the top of the right hand, goes up, then left, then down, ending in an arrowhead pointing left.</p>





ASL Bible Dictionary

Spoken Word	SignWriting
war	<p>The signwriting for 'war' consists of two main components. The first is a handshape with the index finger pointing up and the thumb pointing down, moving from the upper left towards the center. The second is a handshape with the index finger pointing up and the thumb pointing down, moving from the upper right towards the center, with a curved arrow indicating the path.</p>
warm	<p>The signwriting for 'warm' features a handshape with the index finger pointing up and the thumb pointing down, moving from the left towards the center. To its right is a handshape with the index finger pointing up and the thumb pointing down, moving from the right towards the center, with a curved arrow indicating the path. Above the right hand is a circular symbol with a handshape inside, and a chain of small circles connects the two handshapes.</p>
warming-self	<p>The signwriting for 'warming-self' is a multi-part sequence. It starts with two handshapes, each with the index finger pointing up and the thumb pointing down. Below these are two sets of arrows: the first set has a downward arrow on the left and an upward arrow on the right; the second set has an upward arrow on the left and a downward arrow on the right. In the center is a handshape with the index finger pointing up and the thumb pointing down, with a small circle above it. Below this is another set of two handshapes, each with the index finger pointing up and the thumb pointing down.</p>
warn	<p>The signwriting for 'warn' consists of a handshape with the index finger pointing up and the thumb pointing down, moving from the left towards the center. To its right is a handshape with the index finger pointing up and the thumb pointing down, moving from the right towards the center, with a curved arrow indicating the path.</p>
warn	<p>The signwriting for 'warn' consists of a handshape with the index finger pointing up and the thumb pointing down, moving from the left towards the center. To its right is a handshape with the index finger pointing up and the thumb pointing down, moving from the right towards the center, with a curved arrow indicating the path. Above the right hand is a handshape with the index finger pointing up and the thumb pointing down, moving from the right towards the center, with a curved arrow indicating the path.</p>
warn	<p>The signwriting for 'warn' consists of a handshape with the index finger pointing up and the thumb pointing down, moving from the left towards the center. To its right is a handshape with the index finger pointing up and the thumb pointing down, moving from the right towards the center, with a curved arrow indicating the path. Above the right hand is a handshape with the index finger pointing up and the thumb pointing down, moving from the right towards the center, with a curved arrow indicating the path.</p>
warriors	<p>The signwriting for 'warriors' consists of a handshape with the index finger pointing up and the thumb pointing down, moving from the left towards the center. To its right is a handshape with the index finger pointing up and the thumb pointing down, moving from the right towards the center, with a curved arrow indicating the path. Below these are two handshapes, each with the index finger pointing up and the thumb pointing down, moving from the left towards the center, with a curved arrow indicating the path.</p>



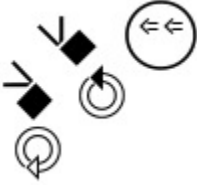
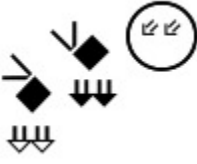

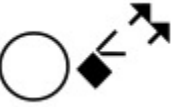
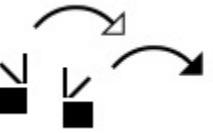
ASL Bible Dictionary

Spoken Word	SignWriting
Warriors	<p>The signwriting for 'Warriors' consists of a vertical sequence of seven symbols: a circle with a vertical line and a downward-pointing arrow, a square with a vertical line and a downward-pointing arrow, a square with a vertical line and a downward-pointing arrow, a square with a vertical line and a downward-pointing arrow, a square with a vertical line and a downward-pointing arrow, a circle with a vertical line and a downward-pointing arrow, and a square with a vertical line and a downward-pointing arrow.</p>
was	<p>The signwriting for 'was' consists of a circle on the left and a square on the right. The square has a vertical line and a downward-pointing arrow. Below the square is another square.</p>
was	<p>The signwriting for 'was' consists of a horizontal line on the left and a square on the right. The square has a vertical line and a downward-pointing arrow.</p>
wash	<p>The signwriting for 'wash' consists of a square with a vertical line and a downward-pointing arrow. To the left of the square is a circle with a vertical line and a downward-pointing arrow.</p>
wash	<p>The signwriting for 'wash' consists of a square with a vertical line and a downward-pointing arrow. To the right of the square is a circle with a vertical line and a downward-pointing arrow.</p>
wash-face	<p>The signwriting for 'wash-face' consists of a circle with a vertical line and a downward-pointing arrow. To the left and right of the circle are squares with vertical lines and downward-pointing arrows.</p>
wash-face	<p>The signwriting for 'wash-face' consists of a circle with a vertical line and a downward-pointing arrow. To the left and right of the circle are squares with vertical lines and downward-pointing arrows.</p>



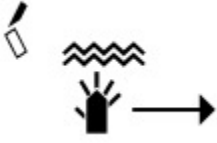
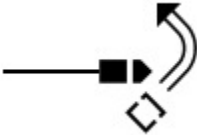

ASL Bible Dictionary

Spoken Word	SignWriting
watch	 <p>SignWriting for 'watch' (look at): A diamond with a downward arrow, a diamond with a downward arrow and a rightward arrow, a diamond with a downward arrow and a leftward arrow, a diamond with a downward arrow and a rightward arrow, a diamond with a downward arrow and a leftward arrow, and a circle with two leftward arrows.</p>
watch	 <p>SignWriting for 'watch' (guard): A diamond with a downward arrow, a diamond with a downward arrow and a rightward arrow, a diamond with a downward arrow and a leftward arrow, a diamond with a downward arrow and a rightward arrow, a diamond with a downward arrow and a leftward arrow, and a circle with two rightward arrows.</p>
watch	 <p>SignWriting for 'watch' (care): A circle with a smiling face, a diamond with a downward arrow and a rightward arrow, and a diamond with a downward arrow and a leftward arrow.</p>
watch	 <p>SignWriting for 'watch' (guard): A circle with a smiling face, a diamond with a downward arrow and a rightward arrow, and a diamond with a downward arrow and a leftward arrow.</p>
watch	 <p>SignWriting for 'watch' (guard): A circle, a diamond with a downward arrow and a rightward arrow, and a diamond with a downward arrow and a leftward arrow.</p>
watch-over	 <p>SignWriting for 'watch-over' (guard): A diamond with a downward arrow and a rightward arrow, a diamond with a downward arrow and a leftward arrow, and a diamond with a downward arrow and a rightward arrow.</p>
Water	 <p>SignWriting for 'Water': A diamond with a downward arrow and a rightward arrow, a diamond with a downward arrow and a leftward arrow, a diamond with a downward arrow and a rightward arrow, and a diamond with a downward arrow and a leftward arrow.</p>
water	 <p>SignWriting for 'water': A circle, a diamond with a downward arrow and a rightward arrow, and a diamond with a downward arrow and a leftward arrow.</p>





ASL Bible Dictionary

Spoken Word	SignWriting
water	
water	
water-bubbles	
water-fountain	
water-house	
water-near-boat	
water-out-of	





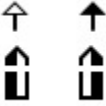
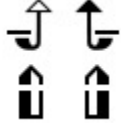
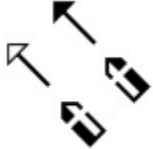
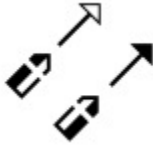

ASL Bible Dictionary

Spoken Word	SignWriting
wave	
wave	
wave	
wave	
wave	



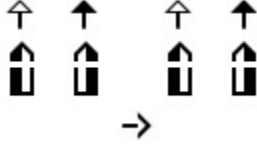



ASL Bible Dictionary

Spoken Word	SignWriting
wave	
wave	
wave-hi	
waver	
waves	
way	
way	
way	
way	



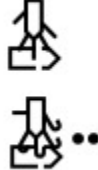
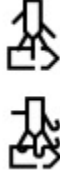

ASL Bible Dictionary

Spoken Word	SignWriting
Way	
Way	
ways	
ways	
waytogo	
wd	
we	
we	



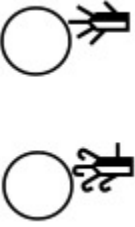
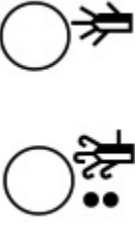

ASL Bible Dictionary

Spoken Word	SignWriting
we	
we	
we	
we	
we-two	
weak	
weak	
weak	

ASL Bible Dictionary

Spoken Word	SignWriting
weak-mind	
weak-mind	
weak-mind	
weak-minded	
weakest	
weapon	

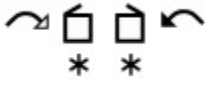
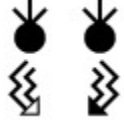
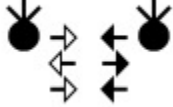

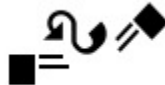





ASL Bible Dictionary

Spoken Word	SignWriting
weapons	
weapons	
wear	
weather	
weather	
weave	
weave	
weave	

ASL Bible Dictionary

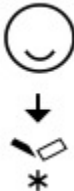
Spoken Word	SignWriting
weave-crown	<p>The signwriting for 'weave-crown' consists of two rows of symbols. The top row features a double-headed arrow on the left, a square with a vertical line through its center, another square with a vertical line through its center, and a double-headed arrow on the right. The bottom row features a curved arrow pointing up and to the right, a hand with fingers spread, a hand with fingers spread, and a curved arrow pointing up and to the left.</p>
weaver-beam	<p>The signwriting for 'weaver-beam' consists of two rows of symbols. The top row features a hand with fingers spread, a hand with fingers spread, and a double-headed arrow pointing down. The bottom row features a double-headed arrow pointing left, two solid black circles, a double-headed arrow pointing right, and a circle containing two upward-pointing arrows.</p>
web	<p>The signwriting for 'web' consists of a single vertical column of symbols: a hand with fingers spread, a solid black circle, a solid black square, and a solid black square.</p>
wedding	<p>The signwriting for 'wedding' consists of two rows of symbols. The top row features a hand with fingers spread, a hand with fingers spread, and a hand with fingers spread. The bottom row features a hand with fingers spread and a hand with fingers spread.</p>
Wednesday	<p>The signwriting for 'Wednesday' consists of a single vertical column of symbols: a hand with fingers spread, a hand with fingers spread, and a hand with fingers spread.</p>
weeds	<p>The signwriting for 'weeds' consists of a single vertical column of symbols: a hand with fingers spread, a solid black circle, a solid black square, a solid black square, a solid black square, a solid black square, and a solid black square.</p>







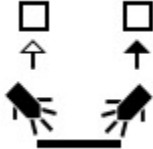
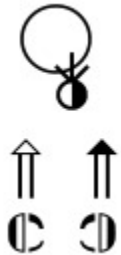
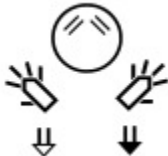
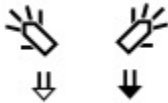
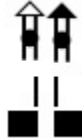
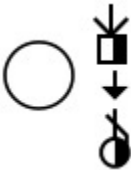
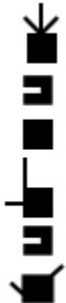

ASL Bible Dictionary

Spoken Word	SignWriting
week	
weekly	
weird	
welcome	
welcome	
welcome	
welcome	
welcome	
welcome	

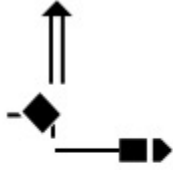





ASL Bible Dictionary

Spoken Word	SignWriting
well	
well	
well	
well	
went	
were	
Wesley	

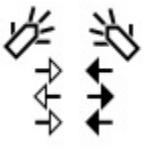





ASL Bible Dictionary

Spoken Word	SignWriting
west	
wet	
whale	
whale	 
whale	
what	
what	
what	

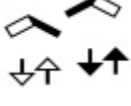

ASL Bible Dictionary

Spoken Word	SignWriting
what	
what	
what	
what	
what	
what	
what	

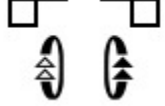

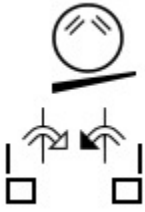
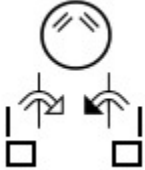
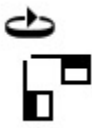

ASL Bible Dictionary

Spoken Word	SignWriting
what	
what's-up	
what??	
whatever	
whatever	
whatever	
wheat	
wheels	

ASL Bible Dictionary

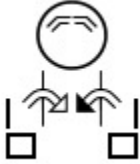
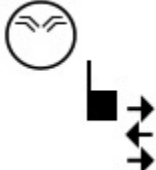
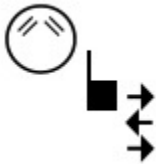
Spoken Word	SignWriting
Whelen	
when	
when	
when	
when	
when	

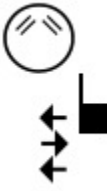
ASL Bible Dictionary

Spoken Word	SignWriting
when	
where	
where	
where	
where	
where	
where	







ASL Bible Dictionary

Spoken Word	SignWriting
where	<p>The SignWriting for 'where' consists of a circle with two horizontal lines inside, representing the mouth. To its right is a hand symbol (a square with a vertical line on the left) with three arrows pointing right, representing the hand movement.</p>
wherever	<p>The SignWriting for 'wherever' consists of two hand symbols (squares with vertical lines) with arrows indicating movement: the left hand moves up and down, and the right hand moves up and down. Below this is a hand symbol with three arrows pointing right, representing the hand movement.</p>
wherever	<p>The SignWriting for 'wherever' consists of a circle with an arrow pointing clockwise, representing a circular motion. Below this is a hand symbol with three arrows pointing right, representing the hand movement.</p>









ASL Bible Dictionary

Spoken Word	SignWriting
whether	<p>The sign for 'whether' is composed of two parts. The top part consists of two L-shaped hand configurations, one on the left and one on the right, each with a downward arrow on the left side and an upward arrow on the right side. The bottom part consists of two vertical lines, one on the left and one on the right, each with a downward arrow on the left side and an upward arrow on the right side.</p>
which	<p>The sign for 'which' is composed of three parts. The top part is a circle with two horizontal lines inside, representing a specific facial expression. Below this are two vertical lines, one on the left and one on the right, each with a downward arrow on the left side and an upward arrow on the right side.</p>
which	<p>The sign for 'which' is composed of two parts. The top part consists of two vertical lines, one on the left and one on the right, each with a downward arrow on the left side and an upward arrow on the right side. The bottom part consists of two vertical lines, one on the left and one on the right, each with a downward arrow on the left side and an upward arrow on the right side.</p>
which	<p>The sign for 'which' is composed of three parts. The top part is a circle with two horizontal lines inside, representing a specific facial expression. Below this is a diagonal line. At the bottom are two vertical lines, one on the left and one on the right, each with a downward arrow on the left side and an upward arrow on the right side.</p>
which	<p>The sign for 'which' is composed of three parts. The top part consists of two vertical lines, one on the left and one on the right, each with a downward arrow on the left side and an upward arrow on the right side. Below this are two vertical lines, one on the left and one on the right, each with a downward arrow on the left side and an upward arrow on the right side.</p>
which	<p>The sign for 'which' is composed of three parts. The top part is a circle with two horizontal lines inside, representing a specific facial expression. Below this is a diagonal line. At the bottom are two vertical lines, one on the left and one on the right, each with a downward arrow on the left side and an upward arrow on the right side.</p>
Whig	<p>The sign for 'Whig' is composed of three parts. The top part is a circle with a dot in the center, representing a specific facial expression. Below this are two vertical lines, one on the left and one on the right, each with a downward arrow on the left side and an upward arrow on the right side.</p>



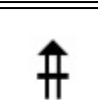

ASL Bible Dictionary

Spoken Word	SignWriting
whip	
whirled	
whirlwind	
whisper	
whisper	
white	
white	



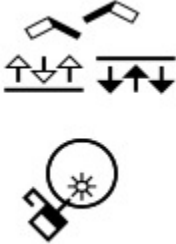

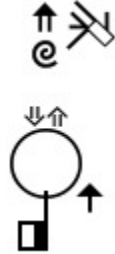



ASL Bible Dictionary

Spoken Word	SignWriting
who	
who	
who	
who	
who	
who	
who	
Who	



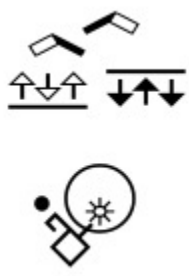





ASL Bible Dictionary

Spoken Word	SignWriting
whoever	
whoever	
whole	
wholehearted	
wholehearted	







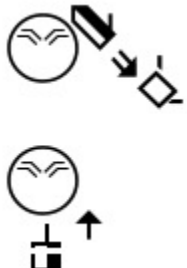

ASL Bible Dictionary

Spoken Word	SignWriting
wholesome	
whoops	
whore	
whore	
whosoever	
why	
why	
why	

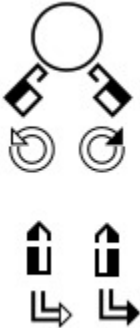
ASL Bible Dictionary

Spoken Word	SignWriting
why	
why	
why	
why	
why	
why	
why	
why	
why-not	

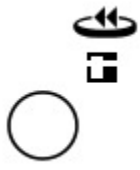



ASL Bible Dictionary

Spoken Word	SignWriting
wicked	
wicked	
wicked	
wide	
widow	
width	
wield	
wife	

ASL Bible Dictionary

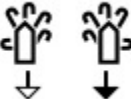
Spoken Word	SignWriting
wild	<p>The sign for 'wild' is represented by a vertical sequence of four symbols: a circle with a vertical line extending upwards from its center, a square, another square, and a circle with a vertical line extending downwards from its center.</p>
wilderness	<p>The sign for 'wilderness' is represented by two parts. The top part shows three arrows: the first points left, the second points right, and the third points right. Below this is a symbol consisting of a vertical line extending upwards from a square, with a spiral line extending from the bottom-left corner of the square.</p>
wilderness	<p>The sign for 'wilderness' is represented by three parts. The top part shows a hand with fingers spread, with a curved arrow above it pointing from the hand towards the left. The middle part shows a hand with fingers spread, with an arrow pointing from the hand towards the right. The bottom part shows a square, a hand with fingers spread, and a tree symbol.</p>
will	<p>The sign for 'will' is represented by a circle and a vertical rectangle with an upward-pointing arrow above it.</p>
will	<p>The sign for 'will' is represented by a circle and a vertical rectangle with a curved arrow above it pointing from the top of the rectangle towards the left.</p>
will	<p>The sign for 'will' is represented by a circle with three upward-pointing arrows above it, and a vertical rectangle with a curved arrow above it pointing from the top of the rectangle towards the left.</p>







ASL Bible Dictionary

Spoken Word	SignWriting
will	
will	
will	
William	
William	
willing	

ASL Bible Dictionary

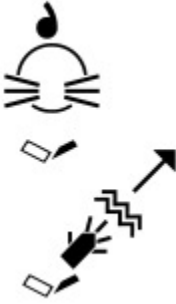
Spoken Word	SignWriting
willing	<p>The sign for 'willing' is composed of three parts: a face with eyes closed and a smile, with a downward arrow above the forehead and an upward arrow above the chin; a hand with the index finger pointing up and a curved arrow indicating a clockwise rotation; and a hand with the index finger pointing up, a horizontal line, and an asterisk below it.</p>
wilson	<p>The sign for 'wilson' is a vertical sequence of seven symbols: a hand with the index finger pointing up, a solid black circle, a hand with the index finger pointing up, a solid black square, a hand with the index finger pointing up, a solid black square, and a hand with the index finger pointing up.</p>
wilt	<p>The sign for 'wilt' consists of three parts: a hand with the index finger pointing up and a triangle to its right; a hand with the index finger pointing up and a horizontal line below it; and a hand with the index finger pointing up and a triangle to its right.</p>
wind	<p>The sign for 'wind' is composed of five hand symbols: a hand with the index finger pointing up, a hand with the index finger pointing up, two horizontal arrows pointing in opposite directions, a hand with the index finger pointing up, and a hand with the index finger pointing up.</p>
wind	<p>The sign for 'wind' is composed of six parts: a hand with the index finger pointing up, a hand with the index finger pointing up, a hand with the index finger pointing up and a semi-circle above it, two horizontal arrows pointing in opposite directions, a hand with the index finger pointing up, and a hand with the index finger pointing up.</p>
wind	<p>The sign for 'wind' is composed of four parts: a hand with the index finger pointing up, a hand with the index finger pointing up, two horizontal arrows pointing in opposite directions, and two horizontal arrows pointing in opposite directions.</p>

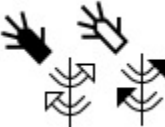





ASL Bible Dictionary

Spoken Word	SignWriting
wind	
wind blows	
wind blows	
window	
windy	
wine	



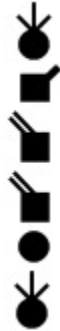

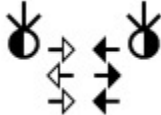
ASL Bible Dictionary

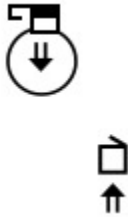
Spoken Word	SignWriting
wineskin	<p>The signwriting for 'wineskin' consists of three parts: a circle with a vertical line through its center and a small circle to its right; a square with a small square inside and a curved arrow pointing right; and a hand with fingers spread, palm facing right.</p>
wineskins	<p>The signwriting for 'wineskins' consists of three parts: a circle with a vertical line through its center and a small circle to its right; a hand with fingers spread, palm facing right; and a square with a small square inside and two curved arrows pointing right.</p>
wing	<p>The signwriting for 'wing' consists of two parts: a circle with a vertical line through its center and a hand with fingers spread, palm facing right; and a hand with fingers spread, palm facing right, with a wavy line above it.</p>
wings	<p>The signwriting for 'wings' consists of a hand with fingers spread, palm facing right, with a horizontal line below it, and another hand with fingers spread, palm facing right, with a horizontal line below it.</p>
wings	<p>The signwriting for 'wings' consists of three parts: a hand with fingers spread, palm facing right, with a horizontal line below it; a circle with a vertical line through its center and a small circle to its right; and a hand with fingers spread, palm facing right, with a horizontal line below it.</p>



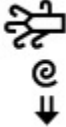
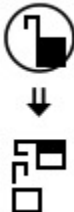





ASL Bible Dictionary

Spoken Word	SignWriting
wings	
wings	
wink	
winnow	
wins	
winter	
wise	
wiser	





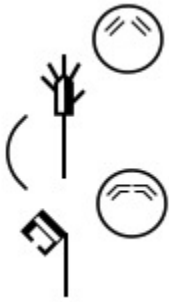

ASL Bible Dictionary

Spoken Word	SignWriting
wisest	
wish	
witch	
with	
with	
with	
with	

ASL Bible Dictionary

Spoken Word	SignWriting
with	
with	
with	
with	
with	
with	
with	
wither	
withers	

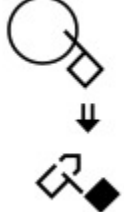
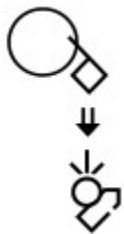
ASL Bible Dictionary

Spoken Word	SignWriting
within	
within	
without	
witness	
witness	
witness	
witnesses	

ASL Bible Dictionary

Spoken Word	SignWriting
wives	<p>The signwriting for 'wives' consists of a circle with a 'W' shape inside, followed by two downward-pointing arrows, and then two hand icons positioned below the arrows.</p>
wives	<p>The signwriting for 'wives' consists of a circle with a 'W' shape inside, followed by a downward-pointing arrow, and then a hand icon positioned below the arrow.</p>
wolf	<p>The signwriting for 'wolf' consists of a hand icon with the index finger pointing up, followed by an upward-pointing arrow, and then a circle containing a stylized 'W' shape.</p>
wolves	<p>The signwriting for 'wolves' consists of a hand icon with the index finger pointing up, followed by two upward-pointing arrows, and then a circle containing a stylized 'W' shape.</p>
woman	<p>The signwriting for 'woman' consists of a circle with a 'W' shape inside, followed by a downward-pointing arrow, and then a hand icon with the index finger pointing up and a small asterisk to its left.</p>
woman	<p>The signwriting for 'woman' consists of a circle with a 'W' shape inside and two diagonal lines on the left side, followed by a downward-pointing arrow, and then a hand icon with the index finger pointing up and a small asterisk to its left.</p>
womb	<p>The signwriting for 'womb' consists of a hand icon with the index finger pointing up, followed by a circle with a dot in the center, then another circle with a dot in the center, then a hand icon with the index finger pointing up, and finally a hand icon with the index finger pointing up.</p>

ASL Bible Dictionary

Spoken Word	SignWriting
women	<p>The signwriting for 'women' consists of a circle with a small square to its right. Below this is a downward-pointing arrow with a small downward-pointing arrow above it. At the bottom is a hand symbol with an asterisk to its left.</p>
wonder	<p>The signwriting for 'wonder' features a circle with a downward arrow above it and an upward arrow below it. To the right is a hand symbol with a small square to its right.</p>
wonderful	<p>The signwriting for 'wonderful' shows two upward-pointing arrows above two vertical bars. A circle is positioned between the two vertical bars.</p>
wonderful	<p>The signwriting for 'wonderful' shows two upward-pointing arrows above two vertical bars.</p>
wonderful	<p>The signwriting for 'wonderful' shows two upward-pointing arrows above two vertical bars. A circle with a downward-pointing arrow is positioned between the two vertical bars.</p>
wonderful	<p>The signwriting for 'wonderful' shows two upward-pointing arrows above two vertical bars. A circle with a downward-pointing arrow is positioned between the two vertical bars.</p>
wonders	<p>The signwriting for 'wonders' shows two upward-pointing arrows above two vertical bars. A circle is positioned between the two vertical bars. Below this is a hand symbol with two vertical bars to its right and wavy lines on either side.</p>

ASL Bible Dictionary

Spoken Word	SignWriting
wonders	<p>The sign for 'wonders' is composed of two parts. The first part shows two hands with fingers spread, positioned around a central circle. Below the circle are two arrows pointing towards each other. The second part shows two hands with fingers spread, positioned around a central circle. Below the circle are two arrows pointing away from each other.</p>
wont	<p>The sign for 'wont' consists of a circle with a hand icon on top, indicating a clockwise rotation. Below the circle is a square with a horizontal line through its center, and an arrow pointing upwards from the right side of the square.</p>
wont	<p>The sign for 'wont' consists of a circle with a hand icon on top, indicating a clockwise rotation. Below the circle is a square with a horizontal line through its center, and an arrow pointing upwards from the right side of the square.</p>
Woo	<p>The sign for 'Woo' consists of three solid black circles arranged vertically. The top circle has a downward-pointing arrow above it.</p>
wood	<p>The sign for 'wood' consists of a square with a hand icon on top, indicating a clockwise rotation. Below the square are three arrows pointing upwards and to the right.</p>
woodrow	<p>The sign for 'woodrow' consists of a vertical sequence of symbols: a circle with a downward-pointing arrow, a solid black circle, another solid black circle, a square with a horizontal line through its center, a circle with a hand icon on top, a solid black circle, a square with a hand icon on top, a solid black circle, and finally a circle with a downward-pointing arrow.</p>





ASL Bible Dictionary

Spoken Word	SignWriting
wool	<p>The SignWriting symbol for 'wool' consists of a vertical line of four circles. The top circle has a starburst shape above it. Below the circles is a horizontal line with a small square on the right side.</p>
Word	<p>The SignWriting symbol for 'Word' consists of three parts: a stylized 'W' shape, a circle containing two small 'w' characters, and a small square with an arrow pointing to the right.</p>
word	<p>The SignWriting symbol for 'word' consists of two small asterisks above a stylized 'W' shape.</p>
word	<p>The SignWriting symbol for 'word' consists of a vertical line of four circles. The top circle has a starburst shape above it. Below the circles is a horizontal line with a small square on the right side.</p>
words	<p>The SignWriting symbol for 'words' consists of a stylized 'W' shape.</p>
work	<p>The SignWriting symbol for 'work' consists of three horizontal lines with arrows pointing to the right, stacked vertically.</p>

ASL Bible Dictionary

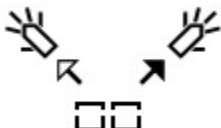
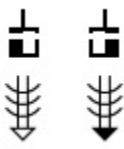
Spoken Word	SignWriting
worker	<p>The SignWriting for 'worker' consists of a central vertical stack of three horizontal bars. Above the top bar is a hand symbol with fingers pointing down. Below the bottom bar are two hand symbols, each with fingers pointing up and a small downward arrow below it.</p>
workers	<p>The SignWriting for 'workers' is similar to 'worker' but includes a small L-shaped arrow pointing down and then right, located below each of the two bottom hand symbols.</p>
working	<p>The SignWriting for 'working' is identical to the SignWriting for 'worker'.</p>
works	<p>The SignWriting for 'works' is identical to the SignWriting for 'worker' but includes a small circular arrow pointing clockwise to the right of the central vertical stack.</p>
workshop	<p>The SignWriting for 'workshop' features two small squares at the top, two solid black circles below them, and two hand symbols with fingers pointing down. Curved arrows on the left and right sides point towards the central elements.</p>
world	<p>The SignWriting for 'world' features a hand symbol with fingers pointing down on the left, a hand symbol with fingers pointing up on the right, and a central circular arrow pointing clockwise.</p>

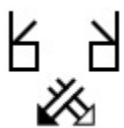



ASL Bible Dictionary

Spoken Word	SignWriting
wormwood	
worn-out	
worse	
worse	
worse	
worship	
worship	





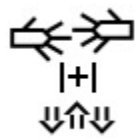
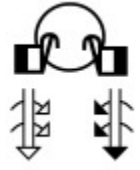
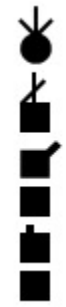
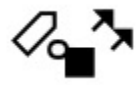

ASL Bible Dictionary

Spoken Word	SignWriting
worship	<p>The signwriting consists of a circle on the left, a square with a downward-pointing arrow on the right, and a downward-pointing arrow below the square.</p>
worship	<p>The signwriting consists of a circle with two arrows pointing towards the center, a square with a downward-pointing arrow on the right, and a diagonal line with an arrow pointing down and to the right below the square.</p>
worship	<p>The signwriting consists of a square with a downward-pointing arrow on the left, a circle on the right, and a downward-pointing arrow below the square.</p>
worshiper	<p>The signwriting consists of a circle with two arrows pointing towards the center, a square with a downward-pointing arrow on the right, a downward-pointing arrow below the square, and two vertical arrows pointing up and down on the left side.</p>
worshippers	<p>The signwriting consists of a circle with two arrows pointing towards the center, a square with a downward-pointing arrow on the right, a downward-pointing arrow below the square, and two vertical arrows pointing up and down on the left side, each with a rightward-pointing arrow at the bottom.</p>
worst	<p>The signwriting consists of a horizontal arrow pointing right, a square with a diagonal line from top-left to bottom-right, and a horizontal arrow pointing left.</p>
worthless	<p>The signwriting consists of two hands with fingers spread, one on the left and one on the right, with two black circles above them, each with three lines radiating upwards.</p>

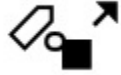



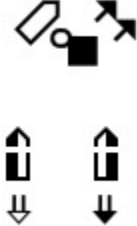

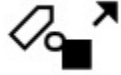
ASL Bible Dictionary

Spoken Word	SignWriting
WOW	
WOW	
WOW	
wreath	
wrestle	
wrinkle	
wrists	
write	

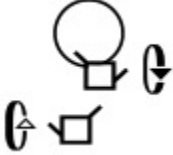
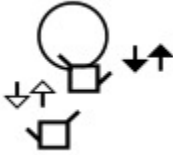

ASL Bible Dictionary

Spoken Word	SignWriting
write	
write	
write	
write	
write-down	
writer	
writes	
writing	
writing	

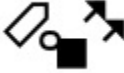



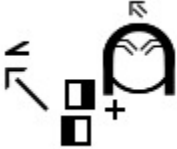
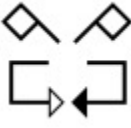



ASL Bible Dictionary

Spoken Word	SignWriting
wrong	
wrong	
wrong	
wrong	
wrong	
wrong	
wrong	
wrongs	 
wrote	

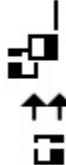

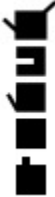



ASL Bible Dictionary

Spoken Word	SignWriting
Yale	
yank	
yard	
yards	

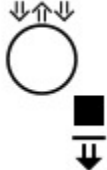
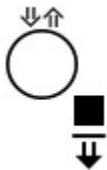





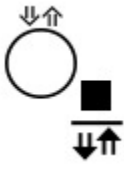

ASL Bible Dictionary

Spoken Word	SignWriting
yay	
Ye	
year	
yearly	
years	
yeast	
yellow	
yes	
yes	

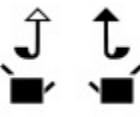
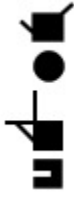







ASL Bible Dictionary

Spoken Word	SignWriting
yes	
yes	
yes	
yes	
yes	
yes	
yes	
yes	
yes	







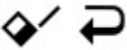

ASL Bible Dictionary

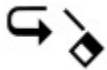
Spoken Word	SignWriting
yes	
yesterday	
yet	
yoke	
yoke	
yoke-put-on	
you	
you	
you	
you	





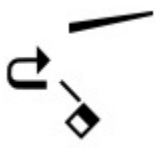

ASL Bible Dictionary

Spoken Word	SignWriting
you	
you	
you	
You	
you	
you	
you	
you	
you	
you	

ASL Bible Dictionary

Spoken Word	SignWriting
you	
You	
you all	
you all	
you-all	
you-all	
you-all	
you-all	
you-all	
you-all	



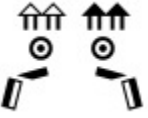
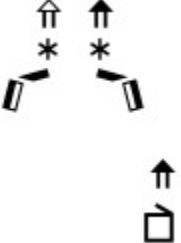



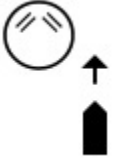

ASL Bible Dictionary

Spoken Word	SignWriting
you-all	
you-all	
you-all-tl	
you-neg	
you-plural	
you-r	
young	
younger	





ASL Bible Dictionary

Spoken Word	SignWriting
youngest	<p>The signwriting for 'youngest' consists of two identical hand configurations side-by-side. Each configuration has the index finger pointing up, the middle finger pointing up, and the ring and pinky fingers pointing down. Below these two configurations is a separate sign: a square with an upward-pointing arrow above it.</p>
your	<p>The signwriting for 'your' is a hand with the index finger pointing up, followed by a curved arrow pointing to the right.</p>
your	<p>The signwriting for 'your' is a hand with the index finger pointing up.</p>
your	<p>The signwriting for 'your' is a hand with the index finger pointing up, followed by a curved arrow pointing to the left.</p>
Your	<p>The signwriting for 'Your' is a hand with the index finger pointing up, followed by an arrow pointing up and to the right.</p>
your	<p>The signwriting for 'your' is a hand with the index finger pointing up, followed by an arrow pointing up and to the right.</p>
your	<p>The signwriting for 'your' is a hand with the index finger pointing up, followed by an arrow pointing up and to the left.</p>
your	<p>The signwriting for 'your' is a hand with the index finger pointing up, followed by a curved arrow pointing to the left.</p>
your	<p>The signwriting for 'your' is a hand with the index finger pointing up, followed by a curved arrow pointing to the left and a diagonal slash mark.</p>
your	<p>The signwriting for 'your' is a hand with the index finger pointing up, followed by a curved arrow pointing to the left and a diagonal slash mark.</p>
your	<p>The signwriting for 'your' is a hand with the index finger pointing up, followed by a curved arrow pointing to the left and a diagonal slash mark.</p>
your	<p>The signwriting for 'your' is a hand with the index finger pointing up, followed by a diagonal slash mark and an arrow pointing up and to the right.</p>

ASL Bible Dictionary

Spoken Word	SignWriting
your	
your	
your	
your	
your	
yourself	
Yvonne	
Z	

ASL Bible Dictionary

Spoken Word	SignWriting
Zaavan	
Zabbai	
Zabdiel	
Zaccai	

ASL Bible Dictionary

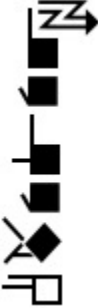
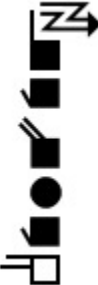
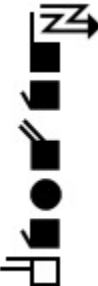
Spoken Word	SignWriting
Zalaph	 <p>The SignWriting for 'Zalaph' consists of a vertical sequence of symbols: a 'Z' with a rightward arrow, a square, a square with a horizontal line, a square, a diamond with a diagonal line, and a square with a horizontal line.</p>
Zanoah	 <p>The SignWriting for 'Zanoah' consists of a vertical sequence of symbols: a 'Z' with a rightward arrow, a square, a square with a horizontal line, a square with a diagonal line, a circle, a square, and a square with a horizontal line.</p>
Zanoah	 <p>The SignWriting for 'Zanoah' consists of a vertical sequence of symbols: a 'Z' with a rightward arrow, a square, a square with a horizontal line, a square with a diagonal line, a circle, a square, and a square with a horizontal line.</p>

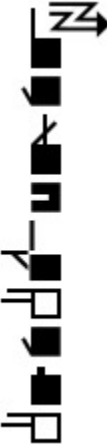
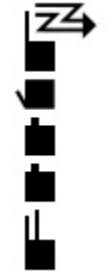

ASL Bible Dictionary

Spoken Word	SignWriting
<p>Zaphnathpaaneah</p>	 <p>The SignWriting for 'Zaphnathpaaneah' is a vertical sequence of 15 symbols. From top to bottom: 1. A 'Z' with a right-pointing arrow. 2. A square. 3. A square with a diagonal line from top-left to bottom-right. 4. A square with a diagonal line from top-right to bottom-left. 5. A square. 6. A square. 7. A square. 8. A square. 9. A square. 10. A square. 11. A square. 12. A square. 13. A square. 14. A square. 15. A square.</p>
<p>Zarephath</p>	 <p>The SignWriting for 'Zarephath' is a vertical sequence of 10 symbols. From top to bottom: 1. A 'Z' with a right-pointing arrow. 2. A square. 3. A square with a diagonal line from top-left to bottom-right. 4. A square with a diagonal line from top-right to bottom-left. 5. A square. 6. A square. 7. A square. 8. A square. 9. A square. 10. A square.</p>
<p>Zattu</p>	 <p>The SignWriting for 'Zattu' is a vertical sequence of 6 symbols. From top to bottom: 1. A 'Z' with a right-pointing arrow. 2. A square. 3. A square. 4. A square. 5. A square. 6. A square.</p>





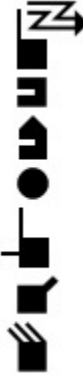

ASL Bible Dictionary

Spoken Word	SignWriting
zeal	<p>The signwriting for 'zeal' consists of four distinct handshapes arranged vertically. The top two are simple upward-pointing arrows. The third is a handshape with the index finger pointing up and the thumb pointing down. The bottom one is a handshape with the index finger pointing up and the thumb pointing down, with a small hook-like shape on the side.</p>
zealot	<p>The signwriting for 'zealot' consists of two main parts. The top part is a handshape with the index finger pointing up and the thumb pointing down, with a small hook-like shape on the side. The bottom part is a handshape with the index finger pointing up and the thumb pointing down, with a small hook-like shape on the side.</p>
Zealot	<p>The signwriting for 'Zealot' is a vertical sequence of handshapes. It starts with a handshape with the index finger pointing up and the thumb pointing down, with a small hook-like shape on the side. This is followed by a handshape with the index finger pointing up and the thumb pointing down, with a small hook-like shape on the side. The sequence ends with a handshape with the index finger pointing up and the thumb pointing down, with a small hook-like shape on the side.</p>
Zebedee	<p>The signwriting for 'Zebedee' is a vertical sequence of handshapes. It starts with a handshape with the index finger pointing up and the thumb pointing down, with a small hook-like shape on the side. This is followed by a handshape with the index finger pointing up and the thumb pointing down, with a small hook-like shape on the side. The sequence ends with a handshape with the index finger pointing up and the thumb pointing down, with a small hook-like shape on the side.</p>

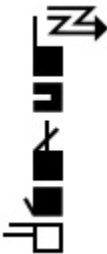
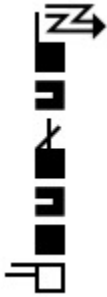

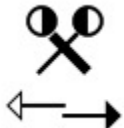

ASL Bible Dictionary

Spoken Word	SignWriting
Zeboim	
Zeboim	
Zeboim	
Zebolim	

ASL Bible Dictionary

Spoken Word	SignWriting
Zerah	
Zeresh	
zero	
zero	
zero	
zero	
zero	



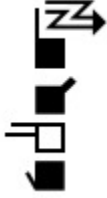
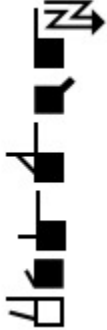
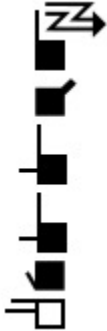
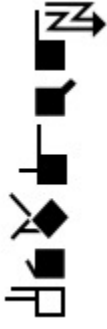

ASL Bible Dictionary

Spoken Word	SignWriting
Zeus	
Zibeon	
Zibeon	
Zicri	
Zidon	



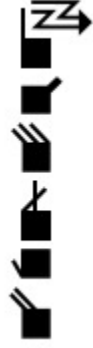

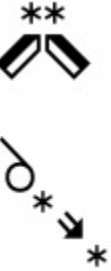
ASL Bible Dictionary

Spoken Word	SignWriting
Ziha	
Ziklag	
Zillah	
Zilpah	

ASL Bible Dictionary

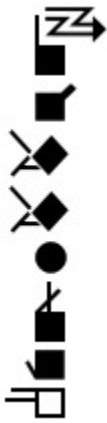
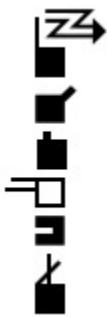
Spoken Word	SignWriting
Zimran	 <p>The SignWriting for 'Zimran' consists of a vertical sequence of eight symbols. From top to bottom: a 'ZZ' symbol with a right-pointing arrow; a square with a small triangle on its top edge; a square with a small triangle on its right edge; a square with a small triangle on its bottom edge; a square with a small triangle on its left edge; a square with a small triangle on its top edge; a square with a small triangle on its right edge; and a square with a small triangle on its bottom edge.</p>
Zion	 <p>The SignWriting for 'Zion' consists of a vertical sequence of six symbols. From top to bottom: a 'ZZ' symbol with a right-pointing arrow; a square with a small triangle on its top edge; a square with a small triangle on its right edge; a solid black circle; a square with a small triangle on its left edge; and a square with a small triangle on its bottom edge.</p>
Zion	 <p>The SignWriting for 'Zion' consists of two symbols. The top symbol is a square with a small triangle on its top edge and a small triangle on its right edge, with two asterisks above it. The bottom symbol is a circle with a small triangle on its top edge, a small triangle on its right edge, and a small triangle on its bottom edge, with three asterisks around it.</p>
Ziphion	 <p>The SignWriting for 'Ziphion' consists of a vertical sequence of eight symbols. From top to bottom: a 'ZZ' symbol with a right-pointing arrow; a square with a small triangle on its top edge; a square with a small triangle on its right edge; a square with a small triangle on its bottom edge; a square with a small triangle on its left edge; a square with a small triangle on its top edge; a solid black circle; and a square with a small triangle on its bottom edge.</p>

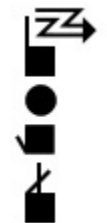
ASL Bible Dictionary

Spoken Word	SignWriting
Zipporah	 <p>The SignWriting for 'Zipporah' consists of the following elements from top to bottom: a 'Z' with a right-pointing arrow, a square, a square with a right-pointing arrow, a diamond with a right-pointing arrow, a diamond with a right-pointing arrow, a circle, a square with a right-pointing arrow, a square with a right-pointing arrow, and a square with a right-pointing arrow.</p>
zither	 <p>The SignWriting for 'zither' consists of the following elements from top to bottom: a 'Z' with a right-pointing arrow, a square with a right-pointing arrow, a square with a right-pointing arrow, a square with a right-pointing arrow, a square with a right-pointing arrow, and a square with a right-pointing arrow.</p>
zither	 <p>The SignWriting for 'zither' consists of the following elements from top to bottom: a square with a right-pointing arrow and a sunburst above it, a square with a right-pointing arrow, a question mark, a colon, a square with a right-pointing arrow, a square with a right-pointing arrow, and a square with a right-pointing arrow.</p>
Zoar	 <p>The SignWriting for 'Zoar' consists of the following elements from top to bottom: a 'Z' with a right-pointing arrow, a square, a circle, a square with a right-pointing arrow, and a square with a right-pointing arrow.</p>
Zohar	 <p>The SignWriting for 'Zohar' consists of the following elements from top to bottom: a 'Z' with a right-pointing arrow, a square, a circle, a square with a right-pointing arrow, a square with a right-pointing arrow, and a square with a right-pointing arrow.</p>

ASL Bible Dictionary

Spoken Word	SignWriting
zoo	<p>The SignWriting for 'zoo' consists of a vertical line with a 'ZZ' symbol at the top, a square, a circle, and another circle below it.</p>
zoom	<p>The SignWriting for 'zoom' consists of a diamond, a vertical line with a square, and an arrow pointing up and to the right.</p>
Zorah	<p>The SignWriting for 'Zorah' consists of a vertical line with a 'ZZ' symbol at the top, a square, a circle, a square, a square, and a square at the bottom.</p>
Zuzims	<p>The SignWriting for 'Zuzims' consists of a vertical line with a 'ZZ' symbol at the top, a square, a square, a 'ZZ' symbol, a square, a square, and a square at the bottom.</p>
zz	
ZZ	<p>The SignWriting for 'ZZ' consists of a square with a 'ZZ' symbol to its right.</p>